

# Soft Recovery Diode

## Types M1565V#400 to M1565V#450

The data sheet on the subsequent pages of this document is a scanned copy of existing data for this product.  
(Rating Report 97D07 Issue 1)

This data reflects the old part number for this product which is: SM36-45C/FXC394. This part number must **NOT** be used for ordering purposes – please use the ordering particulars detailed below.

The limitations of this data are as follows:  
Only VF outline drawing (W43) in datasheet  
Device no longer available for grades 36 & 38 (3600V & 3800V  $V_{RRM}/V_{DRM}$ )

The following links will direct you to the appropriate outline drawings  
[Outline W6](#) – 33mm clamp height capsule  
[Outline W43](#) – 26mm clamp height capsule



Where any information on the product matrix page differs from that in the following data, the product matrix must be considered correct

An electronic data sheet for this product is presently in preparation.

For further information on this product, please contact your local ASM or distributor.

Alternatively, please contact Westcode as detailed below.

<b>Ordering Particulars</b>			
M1565	V#	◆◆	0
Fixed Type Code	VC – 33mm clamp height capsule VF – 26mm clamp height capsule	Voltage code $V_{RRM}/100$ 40-45	Fixed Code
Typical Order Code: M1565VC450, 33mm clamp height capsule, 4500V $V_{RRM}/V_{DRM}$			

<p><b>IXYS Semiconductor GmbH</b> Edisonstraße 15 D-68623 Lampertheim Tel: +49 6206 503-0 Fax: +49 6206 503-627 E-mail: <a href="mailto:marcom@ixys.de">marcom@ixys.de</a></p>	 <p style="font-size: 1.2em;">An  IXYS Company</p> <p style="text-align: center;"><a href="http://www.westcode.com">www.westcode.com</a></p> <p style="text-align: center;"><a href="http://www.ixys.com">www.ixys.com</a></p>	<p><b>Westcode Semiconductors Ltd</b> Langley Park Way, Langley Park, Chippenham, Wiltshire, SN15 1GE. Tel: +44 (0)1249 444524 Fax: +44 (0)1249 659448 E-mail: <a href="mailto:WSL.sales@westcode.com">WSL.sales@westcode.com</a></p>	
<p><b>IXYS Corporation</b> 3540 Bassett Street Santa Clara CA 95054 USA Tel: +1 (408) 982 0700 Fax: +1 (408) 496 0670 E-mail: <a href="mailto:sales@ixys.net">sales@ixys.net</a></p>		<p><b>Westcode Semiconductors Inc</b> 3270 Cherry Avenue Long Beach CA 90807 USA Tel: +1 (562) 595 6971 Fax: +1 (562) 595 8182 E-mail: <a href="mailto:WSI.sales@westcode.com">WSI.sales@westcode.com</a></p>	
<p>The information contained herein is confidential and is protected by Copyright. The information may not be used or disclosed except with the written permission of and in the manner permitted by the proprietors Westcode Semiconductors Ltd.</p> <p>In the interest of product improvement, Westcode reserves the right to change specifications at any time without prior notice.</p> <p>Devices with a suffix code (2-letter, 3-letter or letter/digit/letter combination) added to their generic code are not necessarily subject to the conditions and limits contained in this report.</p>			<p>© Westcode Semiconductors Ltd.</p>

### Fast Recovery Diode Type SM36-45FXC394

	VOLTAGE RATINGS	MAXIMUM LIMITS	UNITS
$V_{RRM}$	Repetitive peak reverse voltage, (note 1).	3600 - 4500	V
$V_{RSM}$	Non-repetitive peak reverse voltage, (note 1).	3700 - 4600	V

	RATINGS	MAXIMUM LIMITS	UNITS
$I_{F(AV)}$	Mean on-state current, $T_{sink}=55^{\circ}C$ double side cooled.	1565	A
$I_{F(AV)}$	Mean on-state current, $T_{sink}=100^{\circ}C$ single side cooled.	460	A
$I_{F(RMS)}$	Nominal RMS on-state current, $T_{sink}=25^{\circ}C$ .	3080	A
$I_{F(d.c.)}$	D.C. on-state current, $T_{sink}=25^{\circ}C$ .	2700	A
$I_{FSM}$	Peak non-repetitive surge $tp=10ms$ , $V_{RM}=0.6V_{RRM}$ , (note 2).	19.7	kA
$I_{FSM2}$	Peak non-repetitive surge $tp=10ms$ , $V_{RM}\leq 10V$ , (note 2).	21.7	kA
$I^2t$	$I^2t$ capacity for fusing $tp=10ms$ , $V_{RM}=0.6V_{RRM}$ , (note 2).	$1.94 \times 10^6$	$A^2s$
$I^2t$	$I^2t$ capacity for fusing $tp=10ms$ , $V_{RM}\leq 10V$ , (note 2).	$2.35 \times 10^6$	$A^2s$
$I^2t$	$I^2t$ capacity for fusing $tp=3ms$ , $V_{RM}\leq 10V$ , (note 2).	$1.75 \times 10^6$	$A^2s$
$T_{HS}$	Operating temperature range.	-40 to +125	$^{\circ}C$
$T_{stg}$	Storage temperature range.	-40 to +150	$^{\circ}C$

Notes:-

- 1) De-rating factor of 0.13% per K is applicable for  $T_j$  below  $25^{\circ}C$ .
- 2) Half-sinewave,  $125^{\circ}C$   $T_j$  initial.

	CHARACTERISTICS	MIN	TYP	MAX	TEST CONDITIONS	UNITS
V <sub>FM</sub>	Maximum peak on-state voltage.	-	-	1.8	I <sub>FM</sub> =2000A.	V
V <sub>0</sub>	Threshold voltage.	-	-	1.09		V
r <sub>s</sub>	Slope resistance.	-	-	0.36		mΩ
I <sub>RRM</sub>	Peak reverse current.	-	-	100	Rated V <sub>RRM</sub> *	mA
		-	-	10	Rated V <sub>RRM</sub> 25 °C.	mA
R <sub>θ</sub>	Thermal resistance.	-	-	0.018	Junction to heatsink, Note 2	K/W
		-	-	0.036	Junction to heatsink, Note 3	K/W
V <sub>FR</sub>	Max. forward Recovery voltage			90	di <sub>F</sub> /dt=1000A/μs	V
Q <sub>RA</sub>	Reverse recovered charge	-	-	2000	I <sub>FM</sub> =1000A, di <sub>R</sub> /dt=200A/μs note 4	μC
F	Mounting torque.	27	-	34		kN
W <sub>t</sub>	Weight.	-	1.3 1.6	-		kg

Notes:-

- 1) Unless otherwise indicated T<sub>J</sub>=125°C. 2) Double side cooled.  
 3) Single side cooled 4) tp=500μs, V<sub>R</sub>=50V

*V. K. S. K.*  
*19-2-98*

ORDERING INFORMATION				(Please quote 10 digit code as below)
<b>S M</b>	♦ ♦	<b>FXC</b>	<b>394</b>	
Fixed Type Code	Voltage Codes 36 - 45	Fixed Outline Code	Fixed Type Code	
Typical order code : SM38FXC394 :- 3800V V <sub>RRM</sub> 26.5mm clamp height capsule.				

Contents	Page
Ratings	1
Characteristics, Ordering Information	2
Contents	3
Voltage grade table 1 Extension of voltage grades	4
<u>Introduction</u>	5
<u>Notes on the Ratings</u>	
(a) Square-wave Ratings	5
(b) Energy per Pulse Characteristics	5
(c) ABCD Constants	5
(d) Reverse Recovery Rating	5
<u>Reverse Recovery Loss</u>	
(a) Determination by Measurement	6
(b) Determination without Measurement	6
<u>Note 1</u> Reverse Recovery Loss by Measurement	7
Computer modelling parameters	7
Fig 1 Limit On-state Characteristics	9
Fig 2 Transient Thermal Impedance	10
Fig 3 Surge Rating	11
Fig 4 Forward Recovery Voltage	12
Fig 5 Recovered Charge 50% Chord $Q_{RA}$	13
Fig 6 Total Recovered Charge $Q_{RR}$	14
Fig 7 Peak Reverse Recovered Current $I_{RM}$	15
Fig 8 Maximum Recovery Time 50% Chord $t_{rr}$	16
Fig 9 Reverse Recovery Energy per Pulse	17
Fig 10 Square Wave Frequency Rating 55°C Sink 100 A/μs	18
Fig 11 Square Wave Frequency Rating 85°C Sink 100 A/μs	19
Fig 12 Square Wave Frequency Rating 55°C Sink 500 A/μs	20
Fig 13 Square Wave Frequency Rating 85°C Sink 500 A/μs	21
Fig 14 Energy per Pulse 100 A/μs	22
Fig 15 Energy per Pulse 500 A/μs	23
Fig 16 Sine Wave Frequency Ratings 55°C Sink	24
Fig 17 Sine Wave Frequency Ratings 85°C Sink	25
Fig 18 Sine Wave Energy per Pulse	26
Fig 19 Outline Drawings	27

Voltage Ratings Table 1

Voltage Class	V <sub>RRM</sub> V	V <sub>RSM</sub> V
36	3600	3700
38	3800	3900
40	4000	4100
42	4200	4300
44	4400	4500
45	4500	4600

Extension of voltage grades

1. This Report is applicable to higher or lower voltage grades when supply has been agreed by Sales/Production.
2. A blocking voltage derating factor of 0.13% per deg. Celsius is applicable to this device for T<sub>J</sub> below 25°C.

## INTRODUCTION

This diode series comprises fast recovery capsule devices with all diffused silicon slices. All these diodes have controlled reverse recovery characteristics with good "K" factors, and are particularly suitable for use in free-wheel applications.

## NOTES ON THE RATINGS

### (a) Square wave ratings

These ratings are given for leading edge linear rates of rise of forward current of 100 and 500 A/ $\mu$ s.

### (b) Energy per pulse characteristics

These curves enable rapid estimation of device dissipation to be obtained for conditions not covered by the frequency ratings.

Let  $E_p$  be the Energy per pulse for a given current and pulse width, in joules. Let  $f$  be the repetition rate, in Hertz. Let  $R_{thJ-HS}$  be the steady state d.c. thermal resistance (junction to heat sink).

Then

$$W_{AV} = E_p * f$$

$$T_{SINK} = T_{J(MAX)} - (E_p * f * R_{thJ-HS})$$

### (c) ABCD Constants

These constants (applicable only over current range of  $V_f$  characteristic on page 8) are the coefficients of the expression for the forward characteristic given below:

$$V_f = A + B.\ln(i_f) + C.i_f + D.\sqrt{i_f}$$

where  $i_f$  = instantaneous forward current.

### (d) Reverse recovery ratings

(i)  $Q_{RA}$  is based on 50%  $I_{RM}$  chord as shown in Fig.1 below.

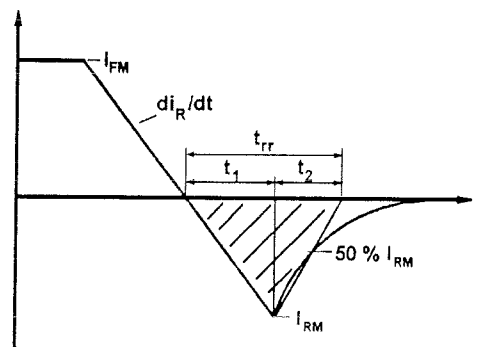

(ii)  $Q_{RR}$  is based on a 150  $\mu$ s integration time

i.e. 
$$Q_{RR} = \int_0^{150\mu s} i_{RR} \cdot dt$$

(iii) 
$$K - Factor = \frac{t1}{t2}$$

### Reverse Recovery Loss

The following procedure is recommended for use where it is necessary to include reverse recovery loss.

#### (a) Determination by measurement

From waveforms of recovery current obtained from a high frequency shunt (see Note 1) and reverse voltage present during recovery, an instantaneous reverse recovery loss waveform must be constructed. Let the area under this waveform be E joules per pulse. A new sink temperature can then be evaluated from:

$$T_{SINK(new)} = T_{SINK(original)} - E * (k + f * R_{th(J-HS)})$$

where  $k = 0.2314$  (K/W)/s

$E =$  Area under reverse loss waveform per pulse in joules (W.s.)

$f =$  Rated frequency in Hz at the original sink temperature.

$R_{th(J-HS)} =$  d.c. thermal resistance (K/W)

$W_{(tot)} = W_{(original)} + E * f$  The total dissipation is now given by

$$W_{(tot)} = W_{(original)} + E * f$$

#### (b) Determination without Measurement

In circumstances where it is not possible to measure voltage and current conditions, or for design purposes, the additional losses E in joules may be estimated as follows.

Let  $E$  be the value of energy per reverse cycle in joules (Fig 9).

Let  $f$  be the operating frequency in Hz

then 
$$T_{SINK(new)} = T_{SINK(original)} - (E * f * R_{th})$$

where  $T_{SINK(new)}$  is the required maximum heat sink temperature and  $T_{SINK(original)}$  is the heat sink temperature given with the frequency ratings.

A suitable R-C snubber network is connected across the diode to restrict the transient reverse voltage waveform to a peak value ( $V_{RM}$ ) of 0.67 of the maximum grade. If a different grade is being used or  $V_{RM}$  is other than 0.67 of Grade, the reverse loss may be approximated by a pro rata adjustment of the maximum value obtained from the curves.

Please note Fig. 9 was produced without a snubber connected.

## NOTE 1

### Reverse Recovery Loss by Measurement

This device has a low reverse recovered charge and peak reverse recovery current. When measuring the charge care must be taken to ensure that:

(a) a.c. coupled devices such as current transformers are not affected by prior passage of high amplitude forward current.

(b) A suitable, polarised, clipping circuit must be connected to the input of the measuring oscilloscope to avoid overloading the internal amplifiers by the relatively high amplitude forward current signal.

(c) Measurement of reverse recovery waveform should be carried out with an appropriate critically damped snubber, connected across diode anode to cathode.

Please note Fig. 9 was produced without a snubber connected.

$$R^2 = 4 * \frac{V_R}{C * di / dt}$$

Where  $V_R$  = Commutating source voltage

C = Snubber capacitance

R = Snubber resistance

### Computer Modelling Parameters

#### 1 Device Dissipation Calculations

$$I_{AV} = \frac{-V_o + \sqrt{V_o^2 - 4 * ff^2 * r_s * (-W_{AV})}}{2 * ff^2 * r_s}$$

Where  $V_o = 1.09V$ ,  $r_s = 0.36m\Omega$   $W_{AV} = \frac{\Delta T}{R_{th}}$   $\Delta T = t_{J \max} - t_{HS}$



(a) Calculating  $V_f$  using ABCD Coefficients

The on-state characteristic  $I_f$  Vs  $V_f$ , on Fig. 1 is represented in two ways; (i) the well established  $V_o$  and  $r_t$  tangent used for rating purposes and (ii) a set of constants A, B, C, D, forming the co-efficients of the representative equation for  $V_f$  in terms of  $I_f$  given below:

$$V_f = A + B \cdot \ln(I_f) + C \cdot I_f + D \cdot \sqrt{I_f}$$

The constants, derived by curve fitting software, are given in this report for both hot and cold characteristics where possible. The resulting values for  $V_f$  agree with the true device characteristic over a current range which is limited to that plotted.

125°C Coefficients		25°C Coefficients	
A	7.511298E-1	A	7.994200E-1
B	2.660584E-3	B	3.014677E-3
C	2.073492E-4	C	8.399341E-5
D	1.393021E-2	D	1.669008E-2

(b) D.C. Thermal Impedance Calculation

$$r_t = \sum_{p=1}^{p=n} r_p (1 - e^{-\frac{t}{\tau_p}})$$

Where  $p = 1$  to  $n$ ,  $n$  is the number of terms in the series.

$t$  = Duration of heating pulse in seconds.

$r_t$  = Thermal resistance at time  $t$ .

$r_p$  = Amplitude of  $p_{th}$  term.

$\tau_p$  = Time Constant of  $r_{th}$  term.

D.C. Double Side Cooled				
Term	1	2	3	4
$r_p$	1.005634e-2	5.404876e-3	1.961208e-3	2.077409e-4
$t_p$	1.328020e0	1.355146e-1	8.946705e-3	8.397134e-3

D.C. Single Side Cooled				
Term	1	2	3	4
$r_p$	2.572981e-2	4.323453e-3	4.194505e-3	1.895927e-3
$t_p$	6.845545e0	5.293073e-1	9.065732e-2	7.557790e-3

Fig. 1 Forward Characteristic of Limit Device

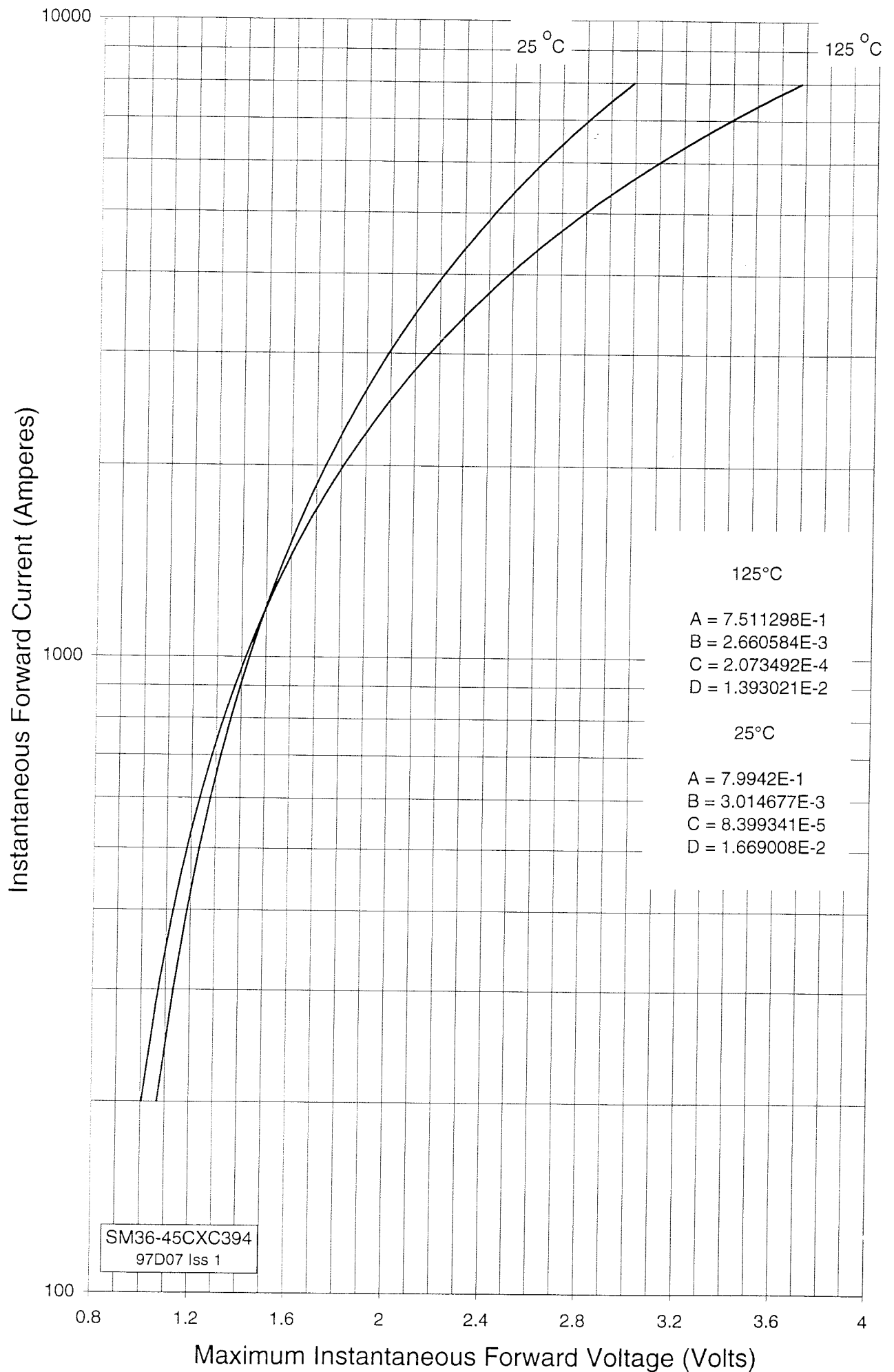

Fig. 2 Transient Thermal Impedance (Junction to Heat Sink)

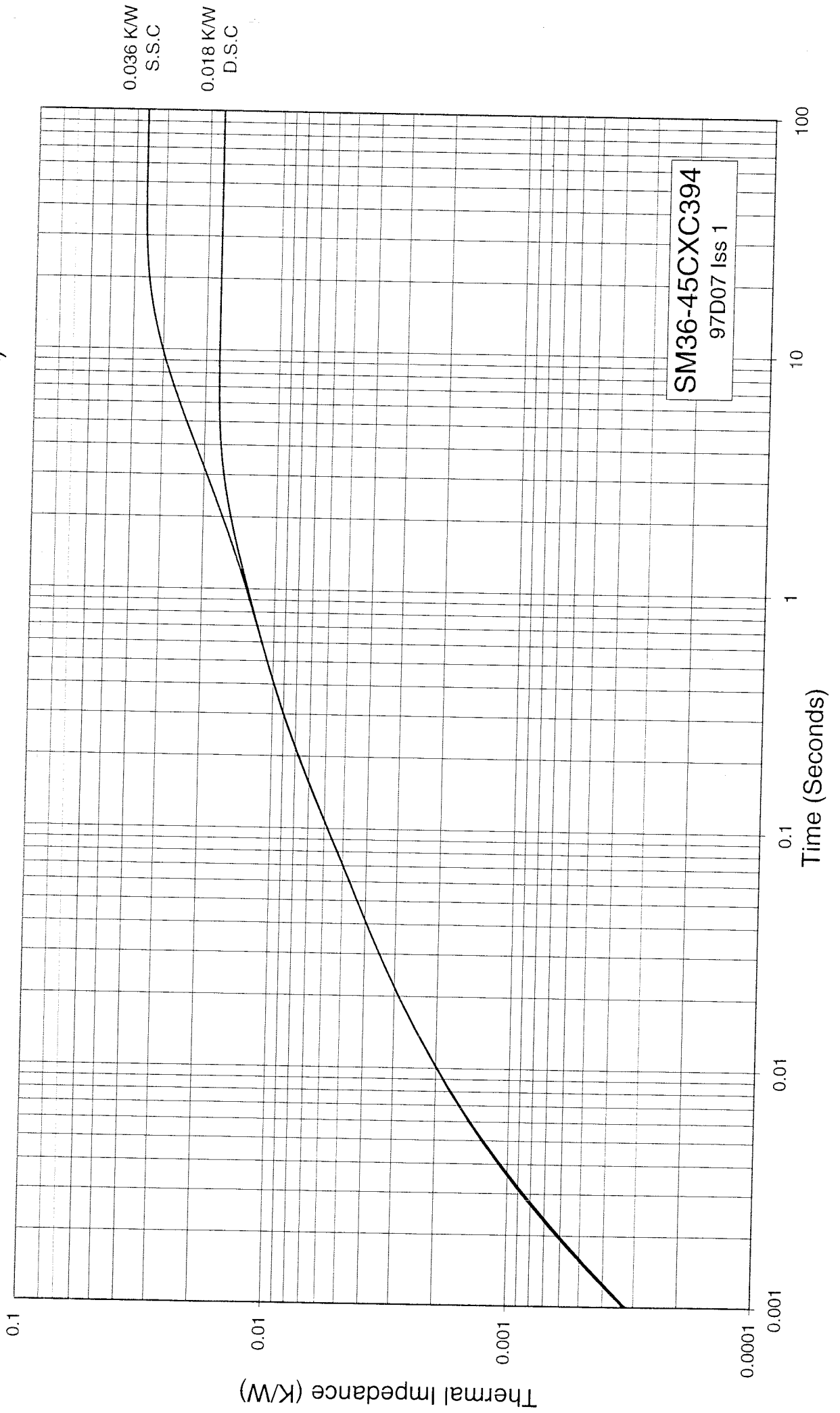

Fig. 3 Maximum Non-Repetitive Surge Current  
 @ Initial Junction Temperature 125 °C

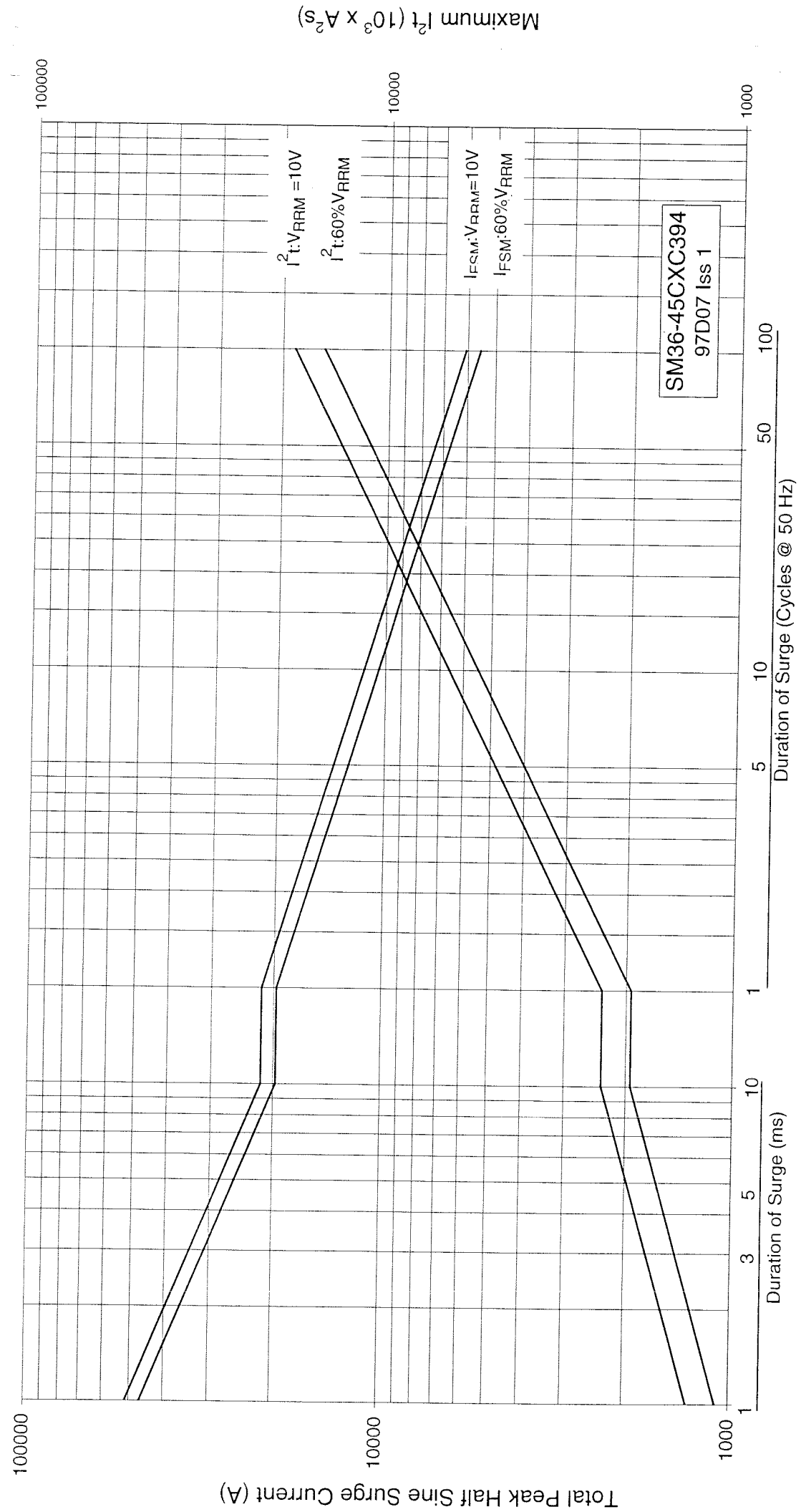

Fig. 4 Forward Recovery Voltage (Maximum Peak)

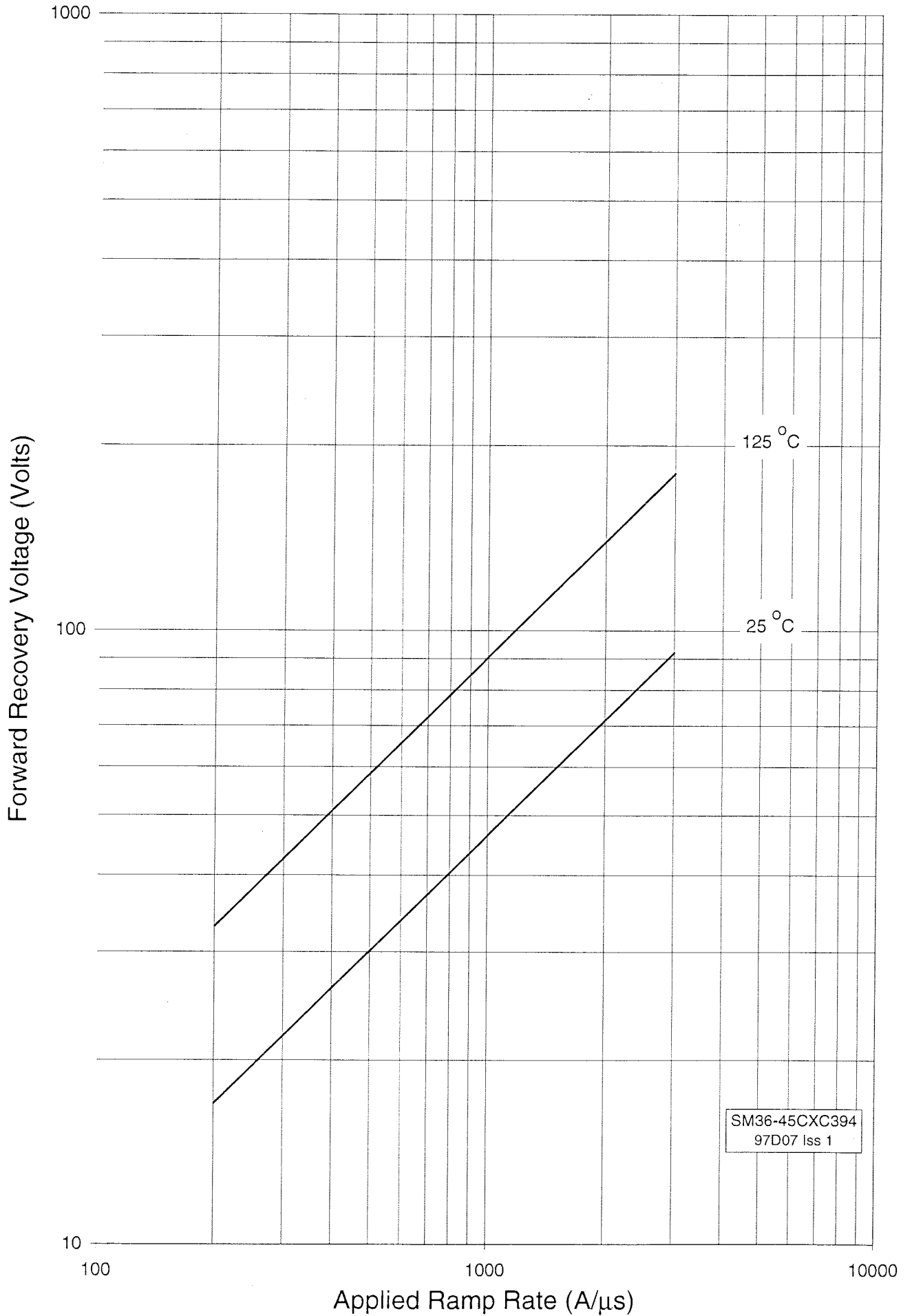
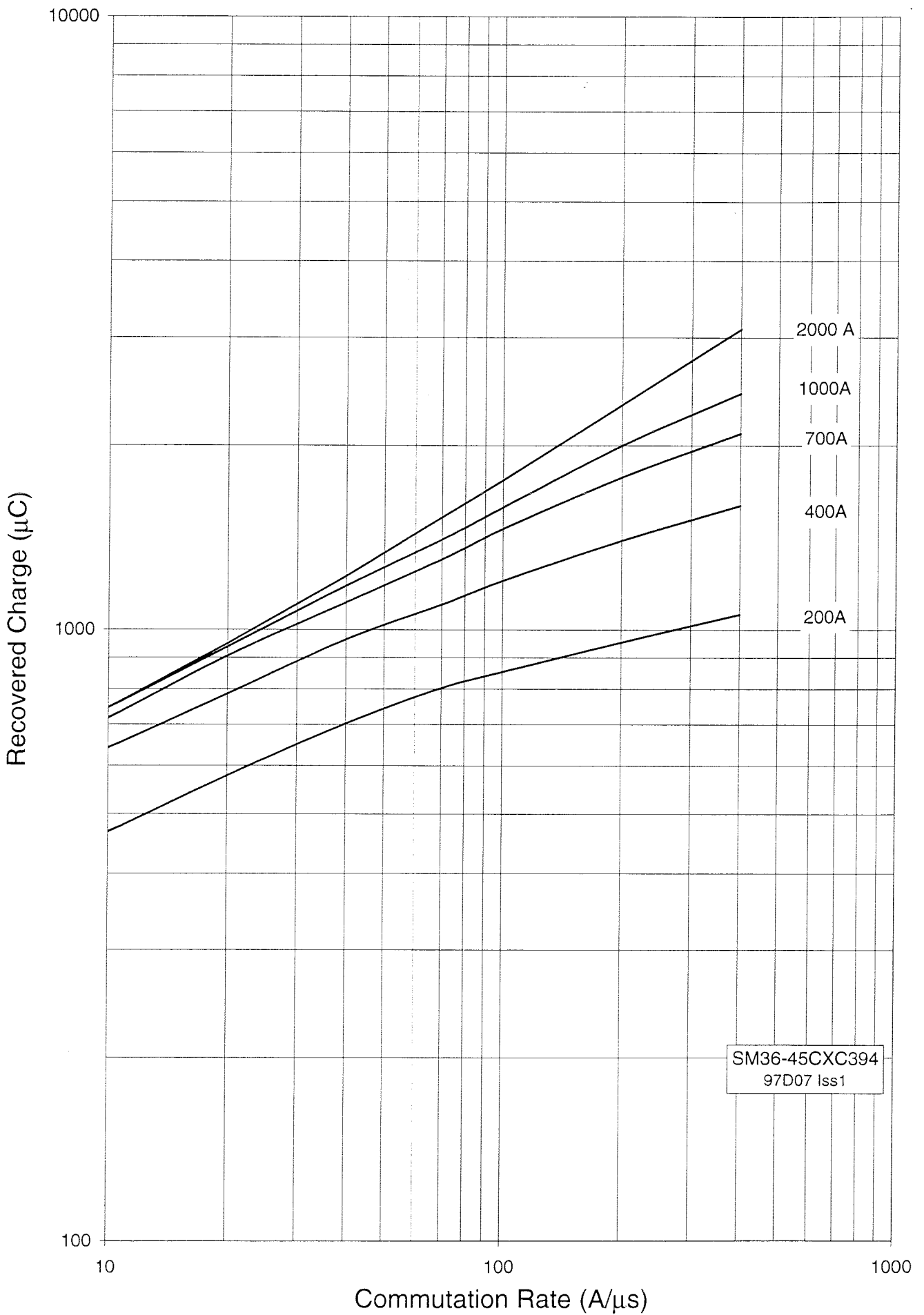

Fig. 5 Maximum Recovered Charge  $Q_{ra}$  50 % Chord  
@ 125 °C Junction Temperature



SM36-45CXC394  
97D07 Iss1

Fig. 6 Maximum Total Recovered Charge  $Q_{rr}$   
@ 125 °C Junction Temperature

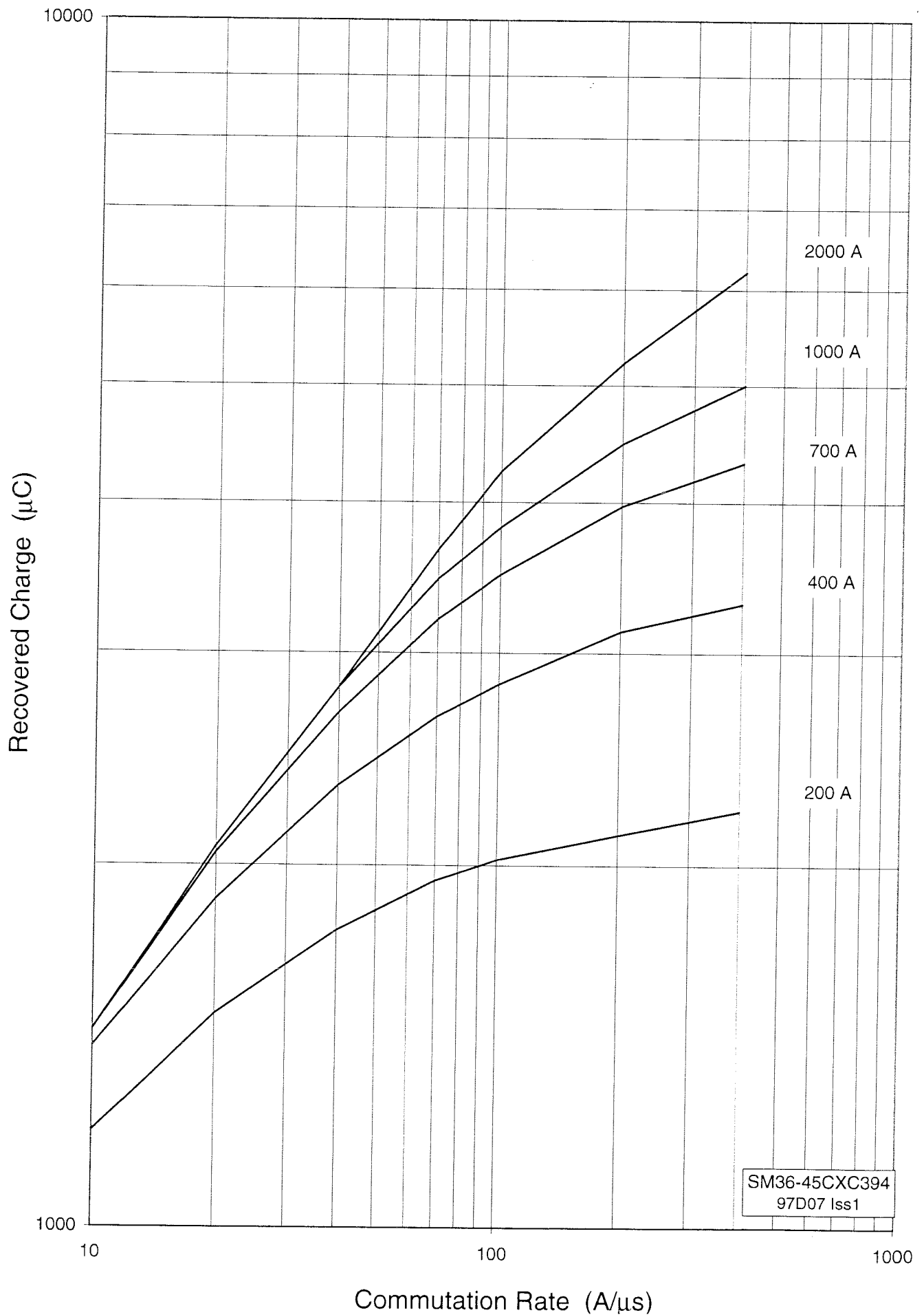

Fig. 7 Maximum Peak Recovered Current  $I_{RM}$   
@ 125 °C Junction Temperature

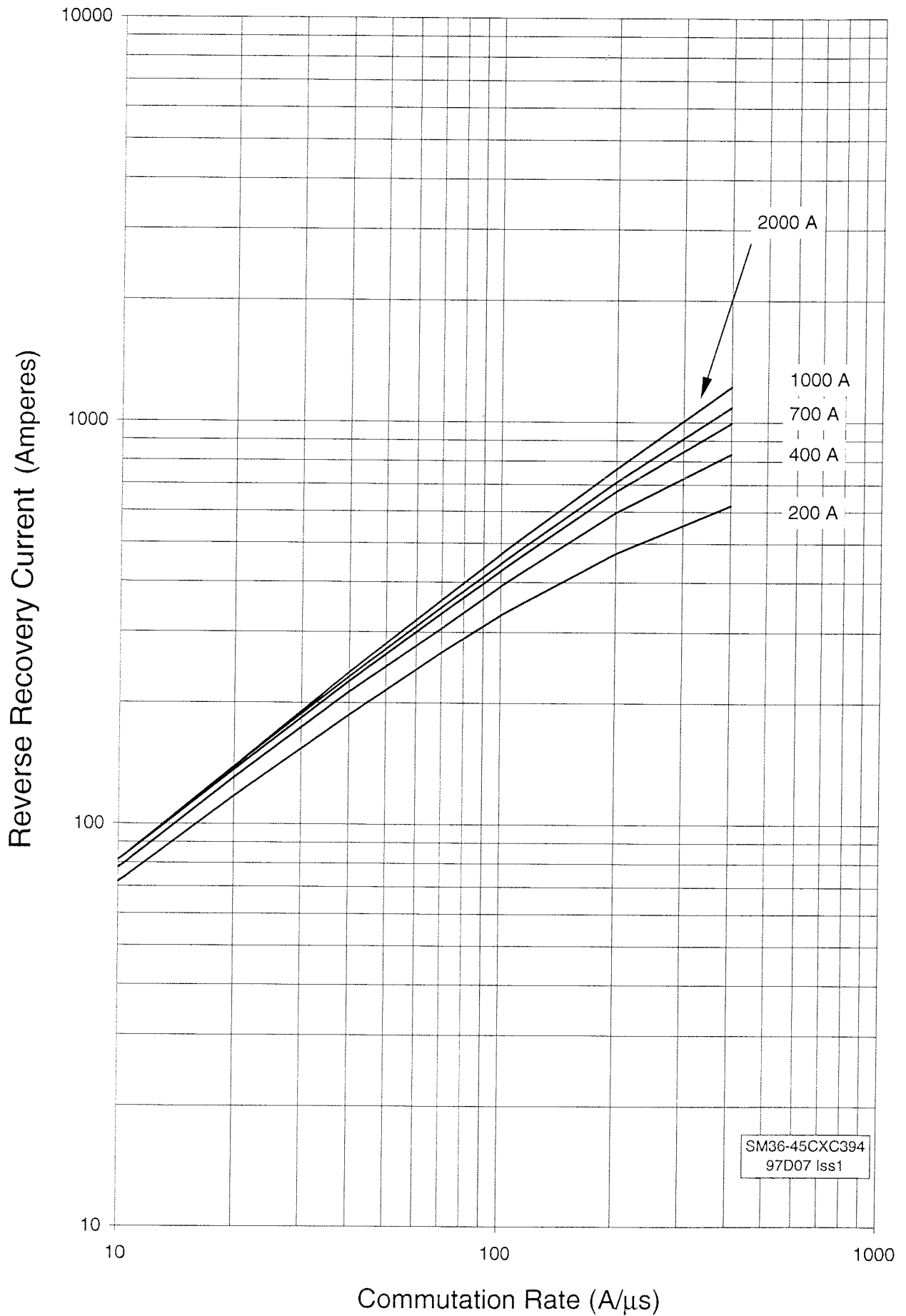



Fig. 8 Maximum Recovery Time  $t_{rr}$   
@125 °C Junction Temperature, 50% Chord

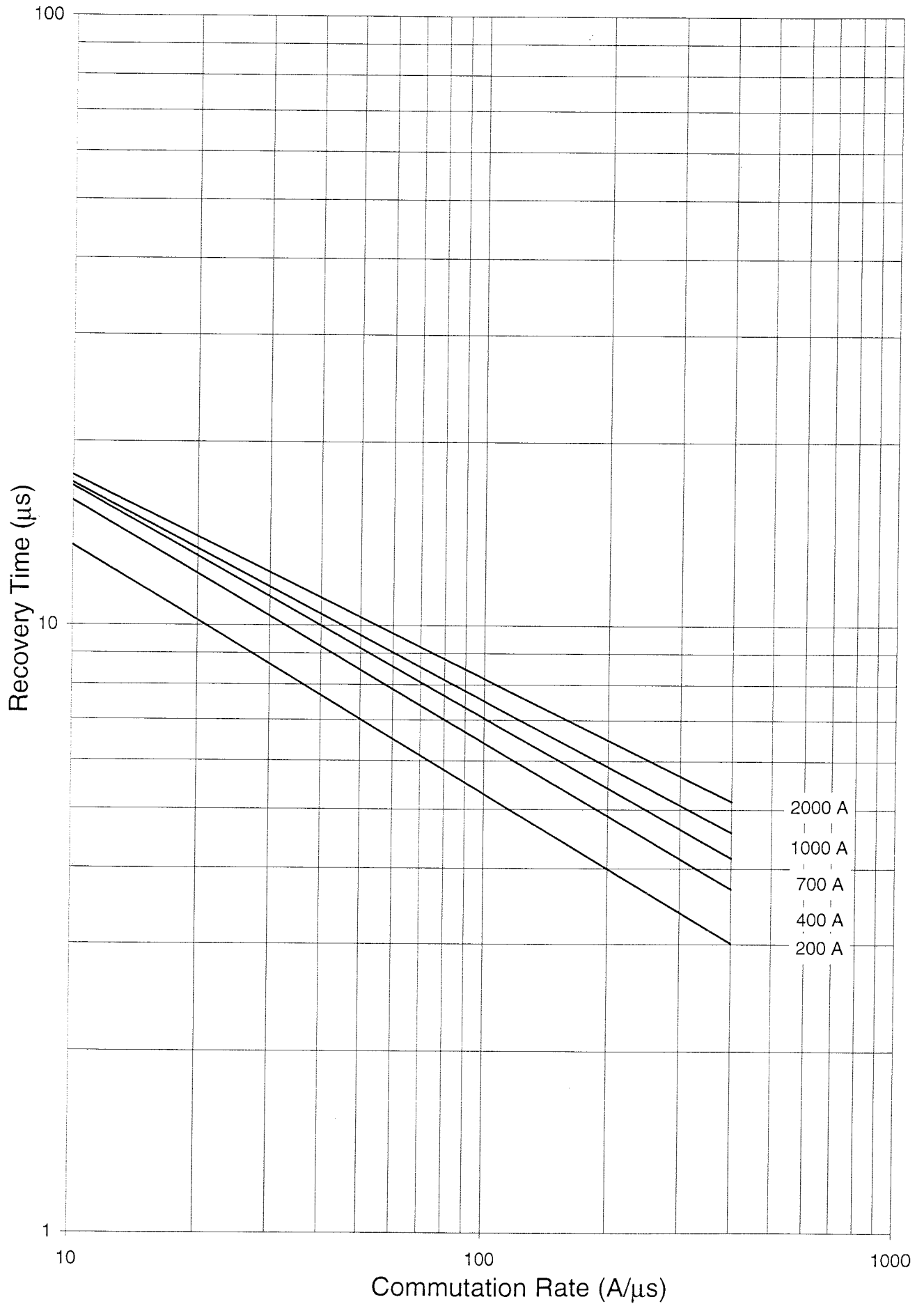

Fig. 9 Maximum Reverse recovered Energy Loss Per Pulse  $E_R$  @ 125 °C Junction Temperature Measured without Snubber .  
 $V_{RM} = 0.67$  Voltage Grade

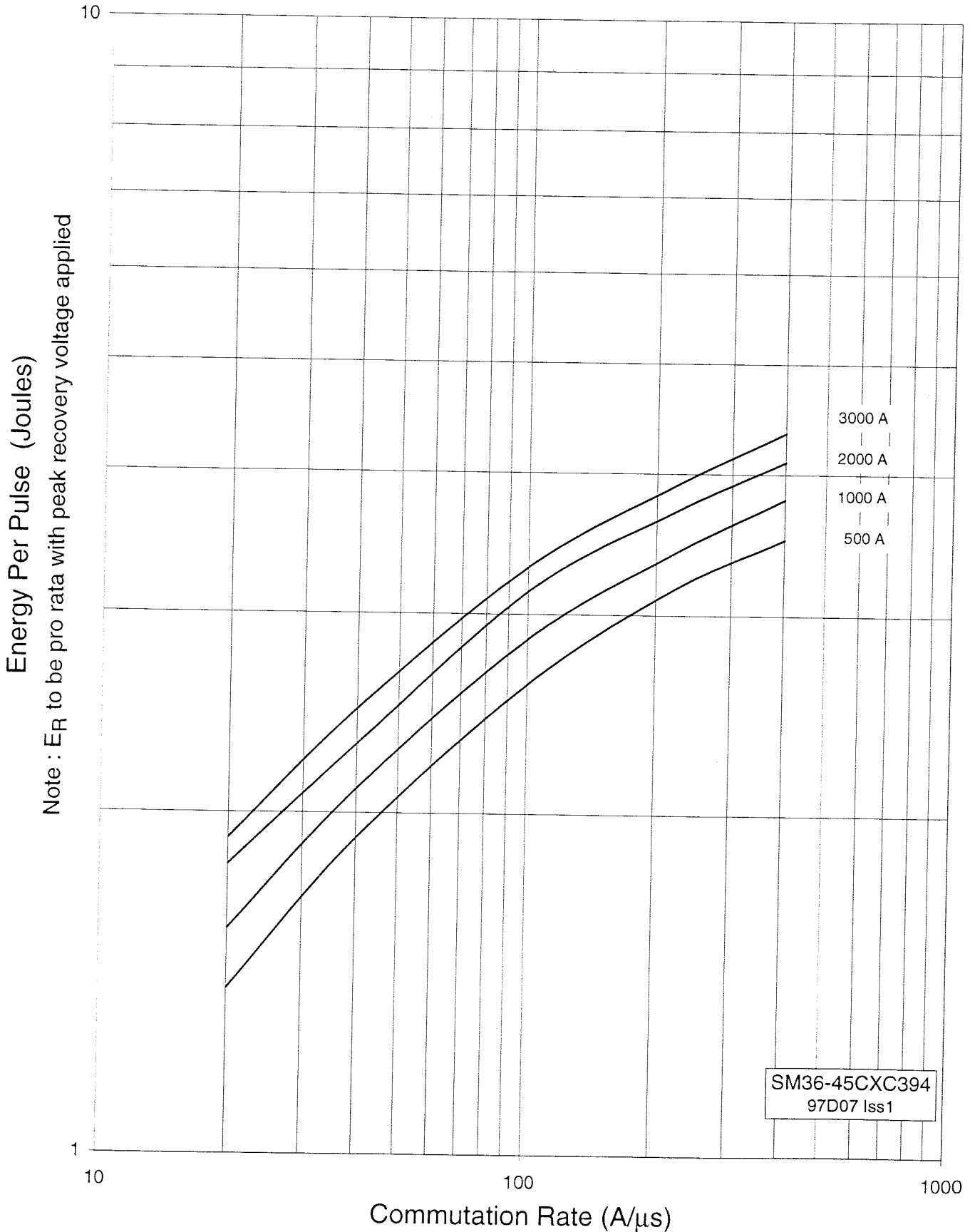

Fig. 10 Frequency vs Pulse Width  
Heat Sink Temperature  $55^{\circ}\text{C}$ ,  $di/dt$   $100\text{ A}/\mu\text{s}$

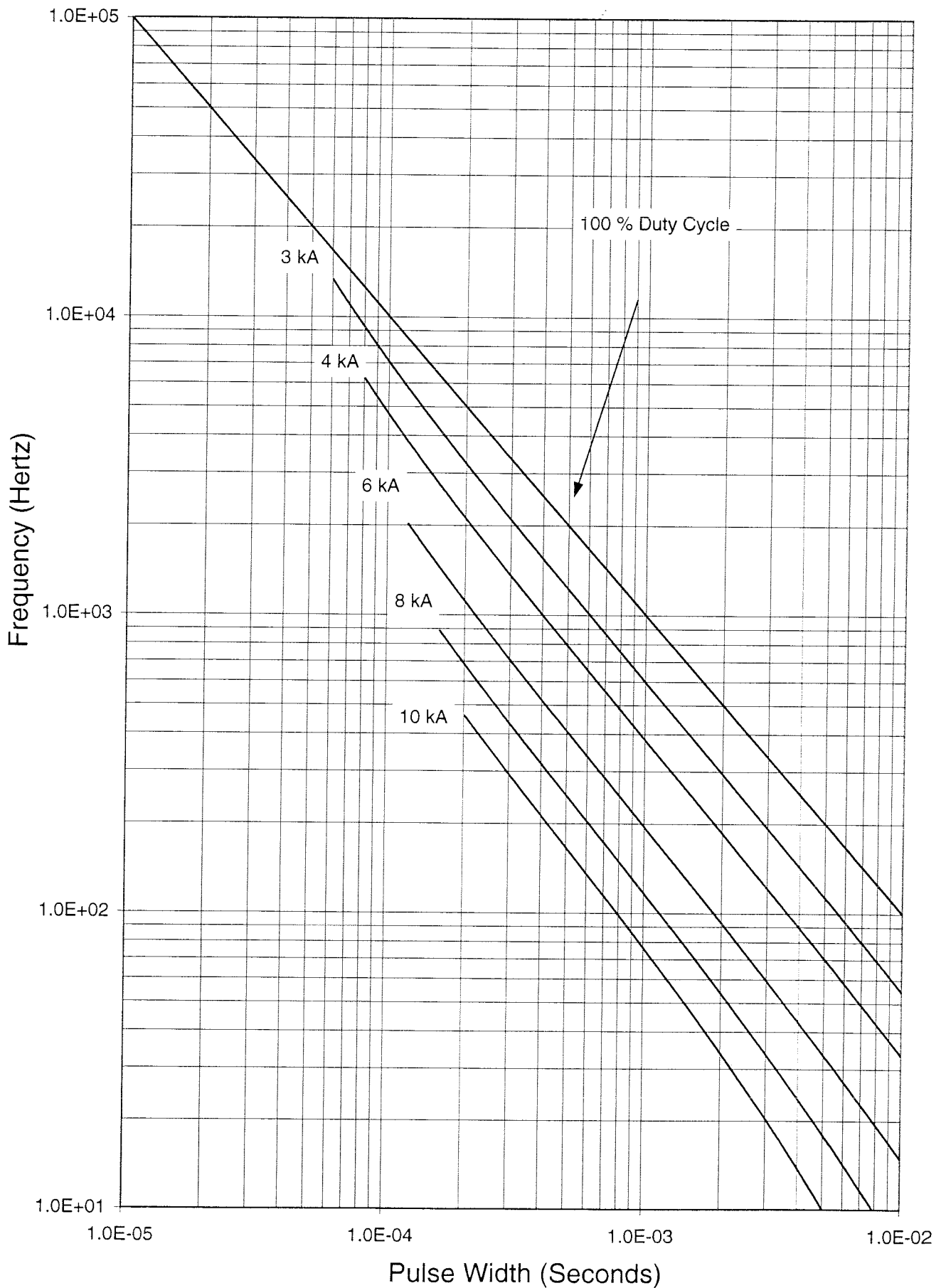

Fig. 11 Frequency vs Pulse Width  
Heat Sink Temperature 85°C, di/dt 100 A/μs

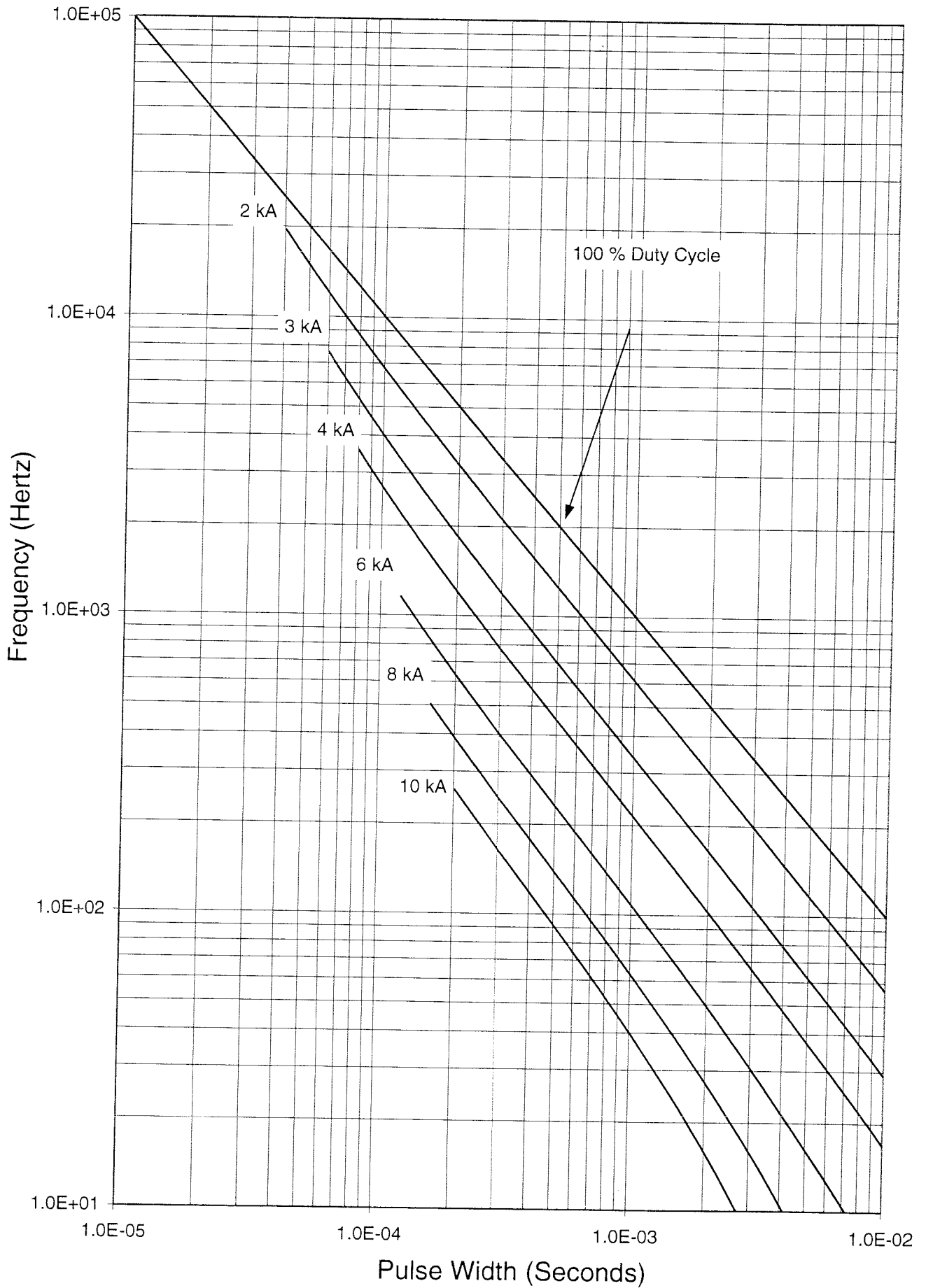

Fig. 12 Frequency vs Pulse Width  
Heat Sink Temperature 55°C, di/dt 500 A/μs

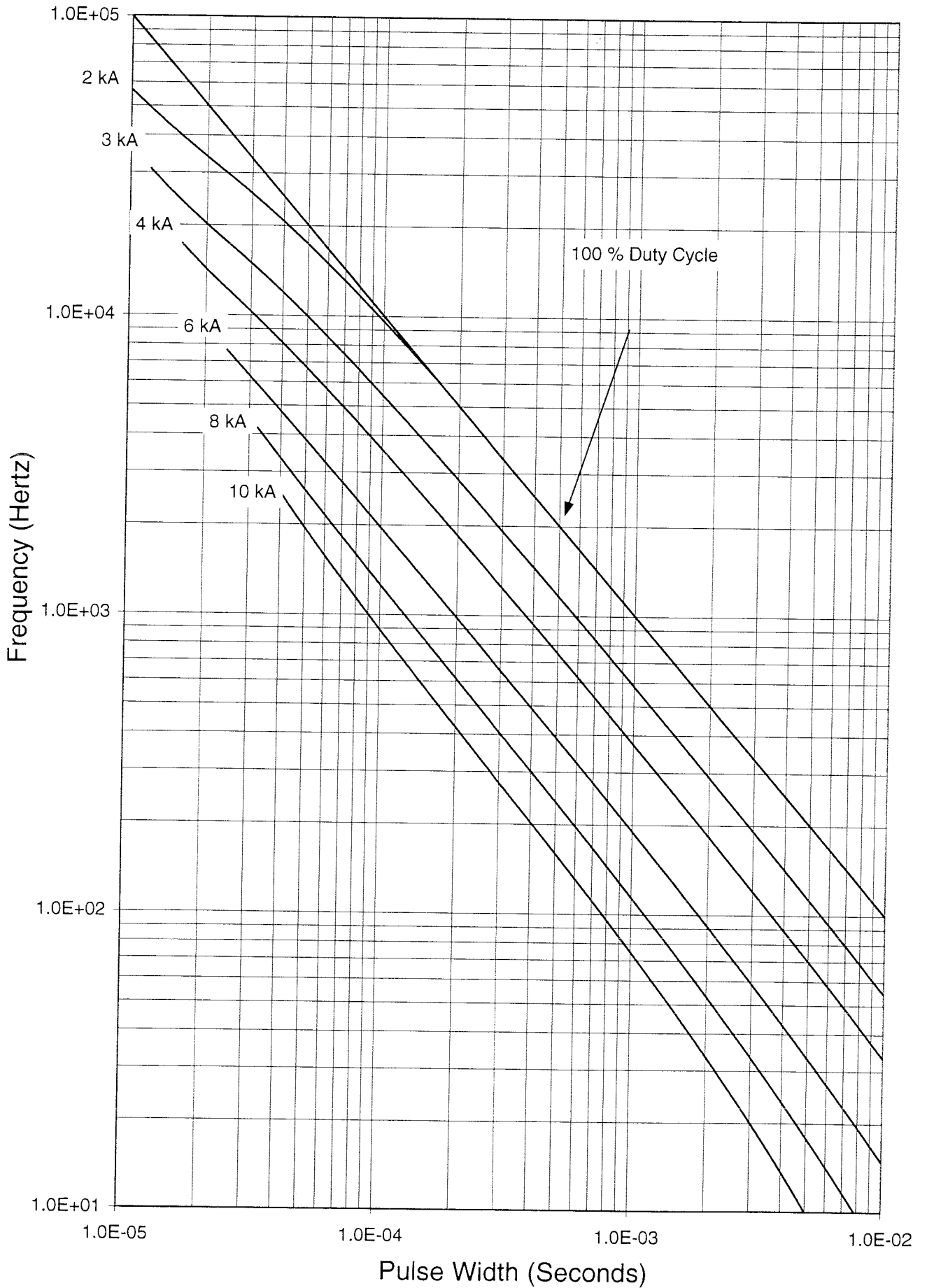

Fig. 13 Frequency vs Pulse Width  
Heat Sink Temperature 85°C, di/dt 500 A/μs

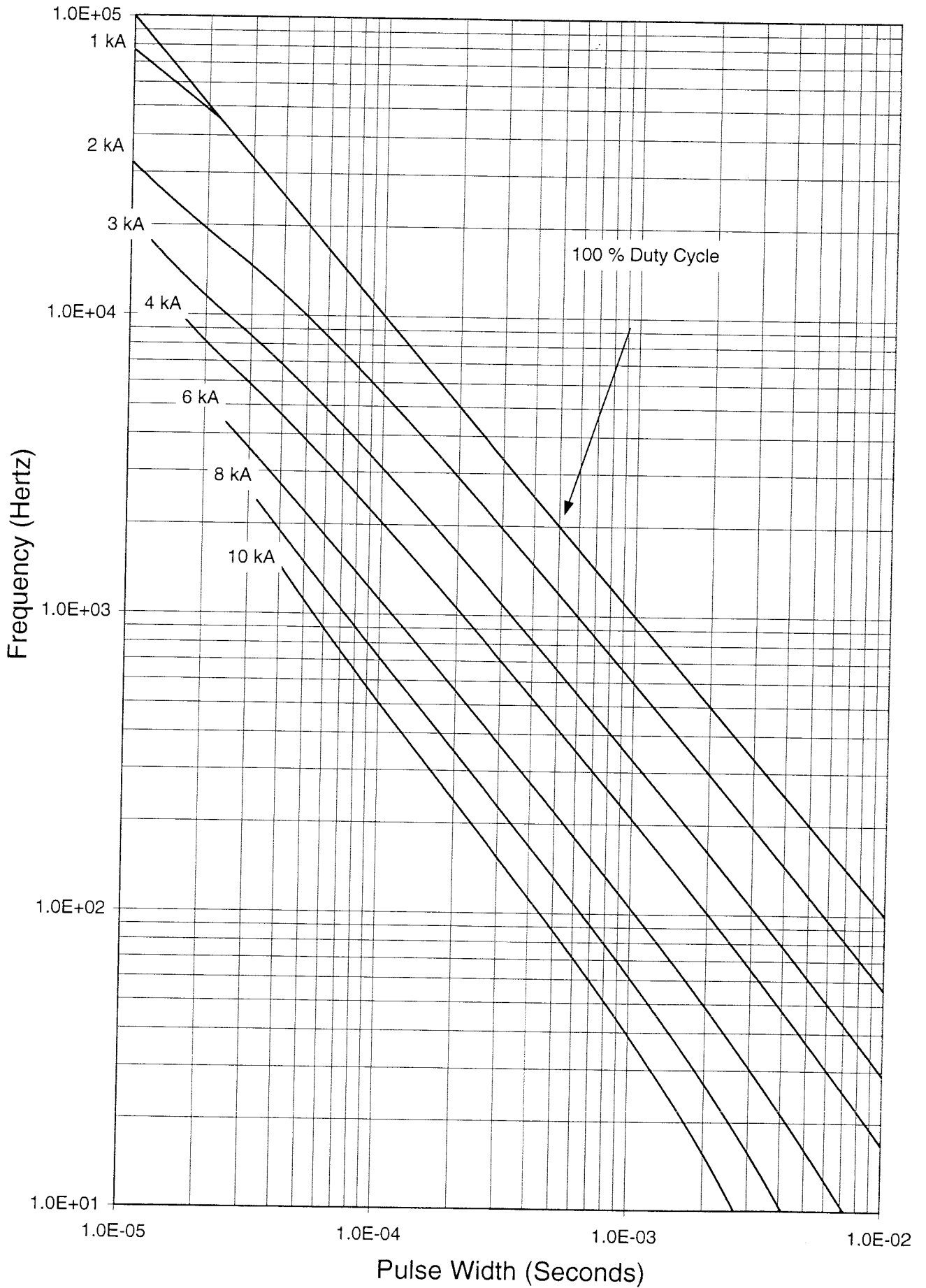

Fig. 14 Energy vs Pulse Width  
Junction Temperature 125 °C, di/dt 100 A/μs

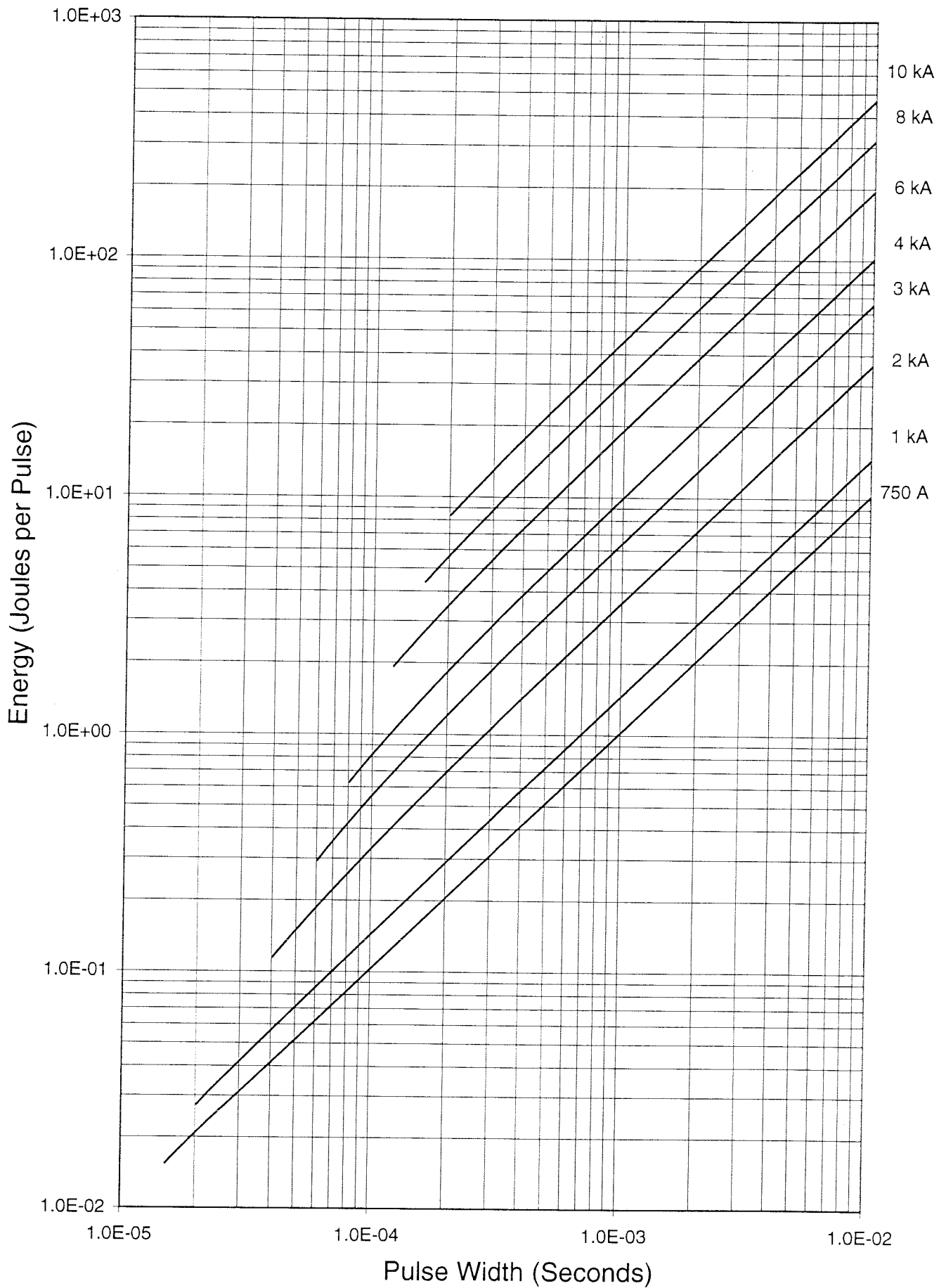

Fig. 15 Energy vs Pulse Width  
Junction Temperature 125 °C, di/dt 500 A/μs

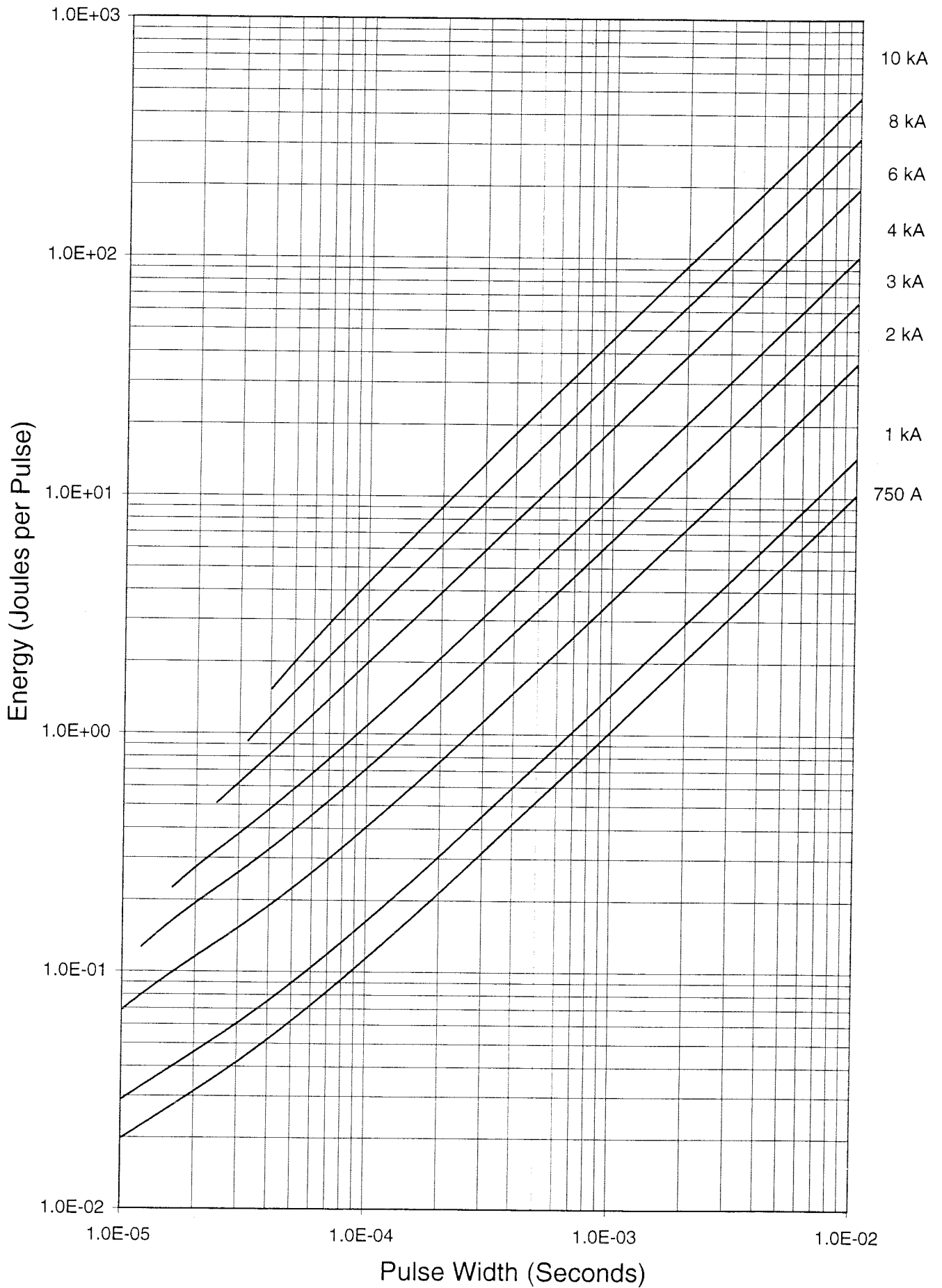



Fig. 16 Frequency vs Pulse Width  
Heat Sink Temperature 55°C, Sine Wave

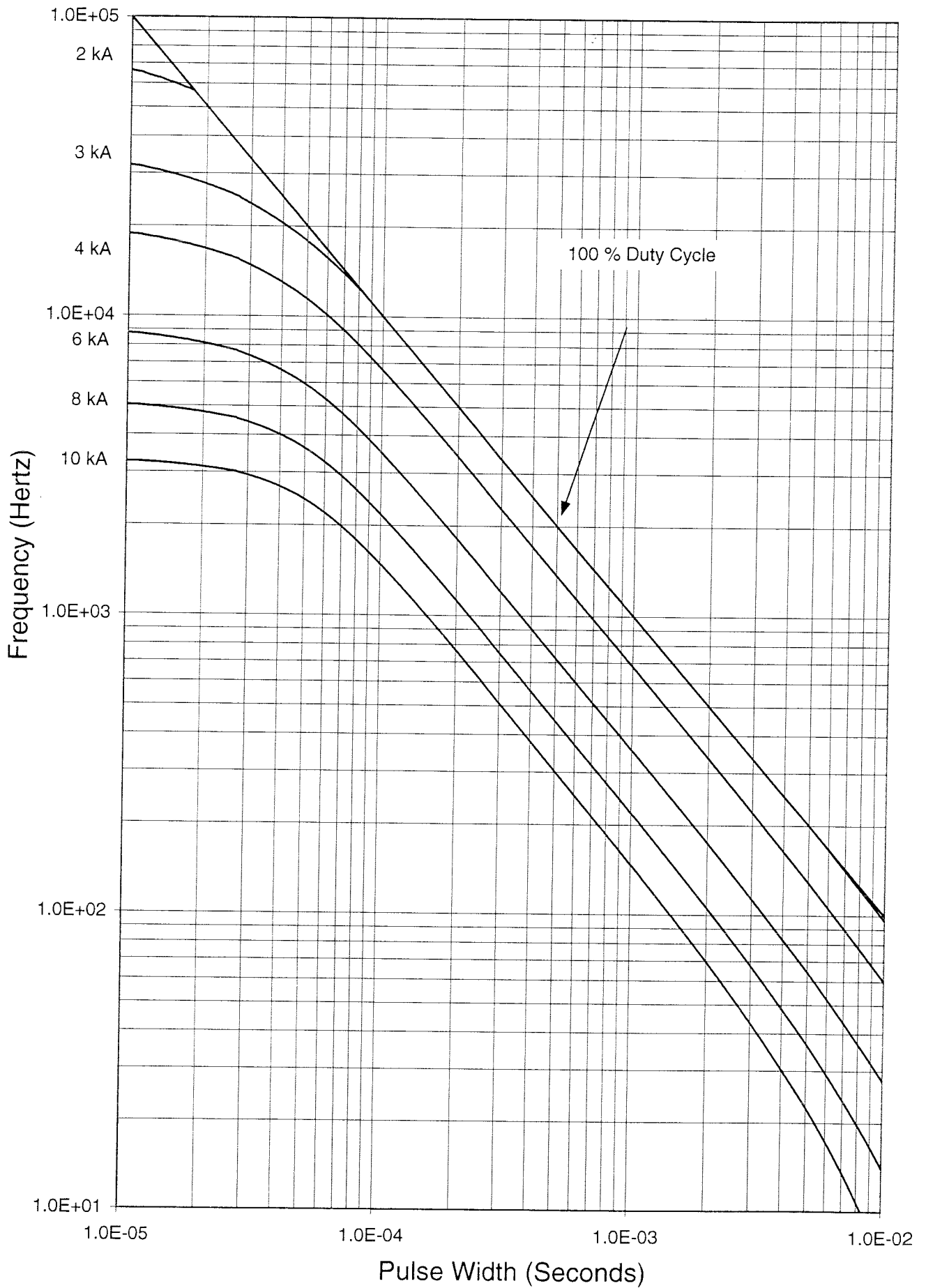

Fig. 17 Frequency vs Pulse Width  
Heat Sink Temperature 85°C, Sine Wave

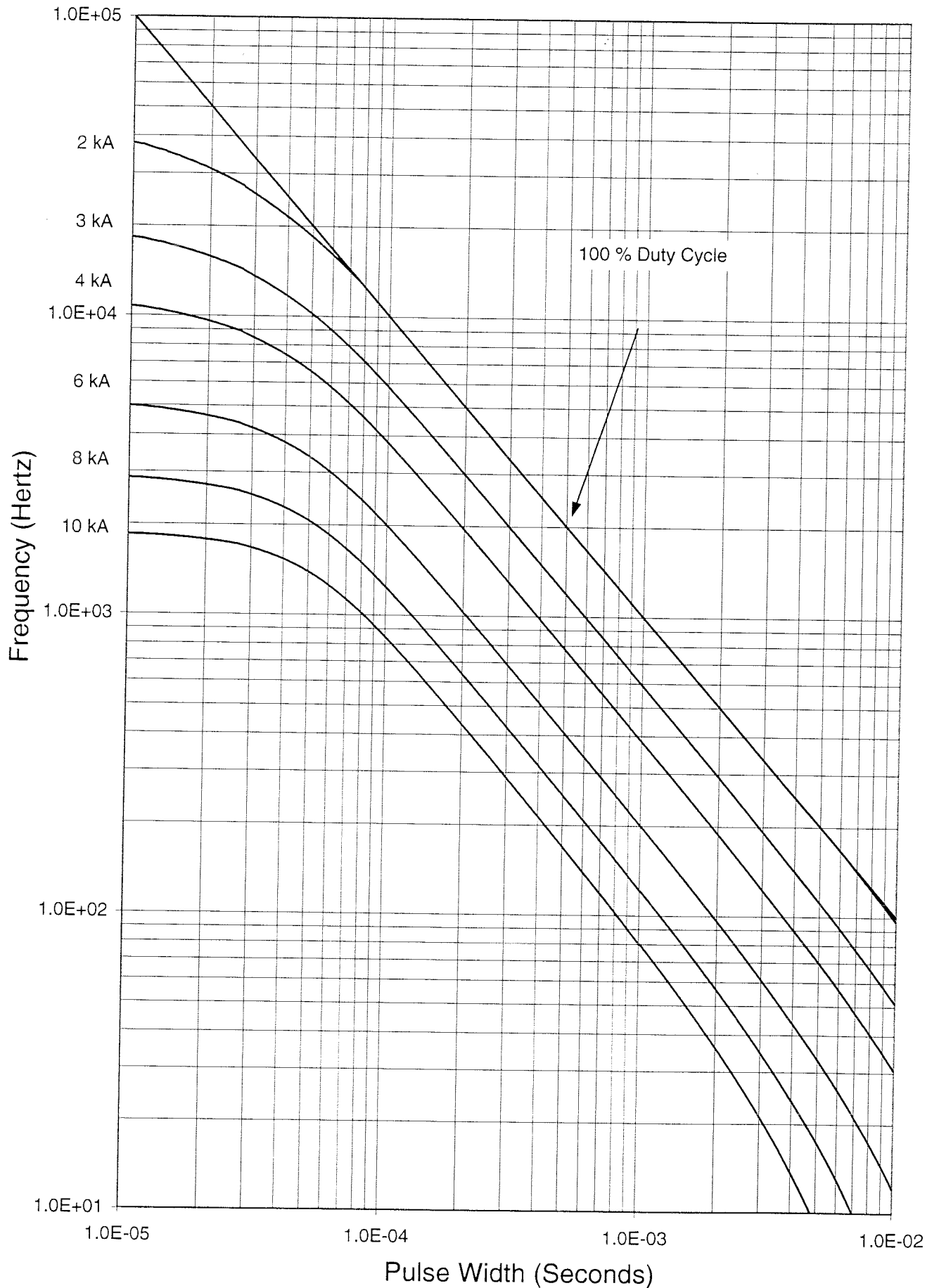

Fig. 18 Energy vs Pulse Width  
Junction Temperature 125 °C, Sine Wave

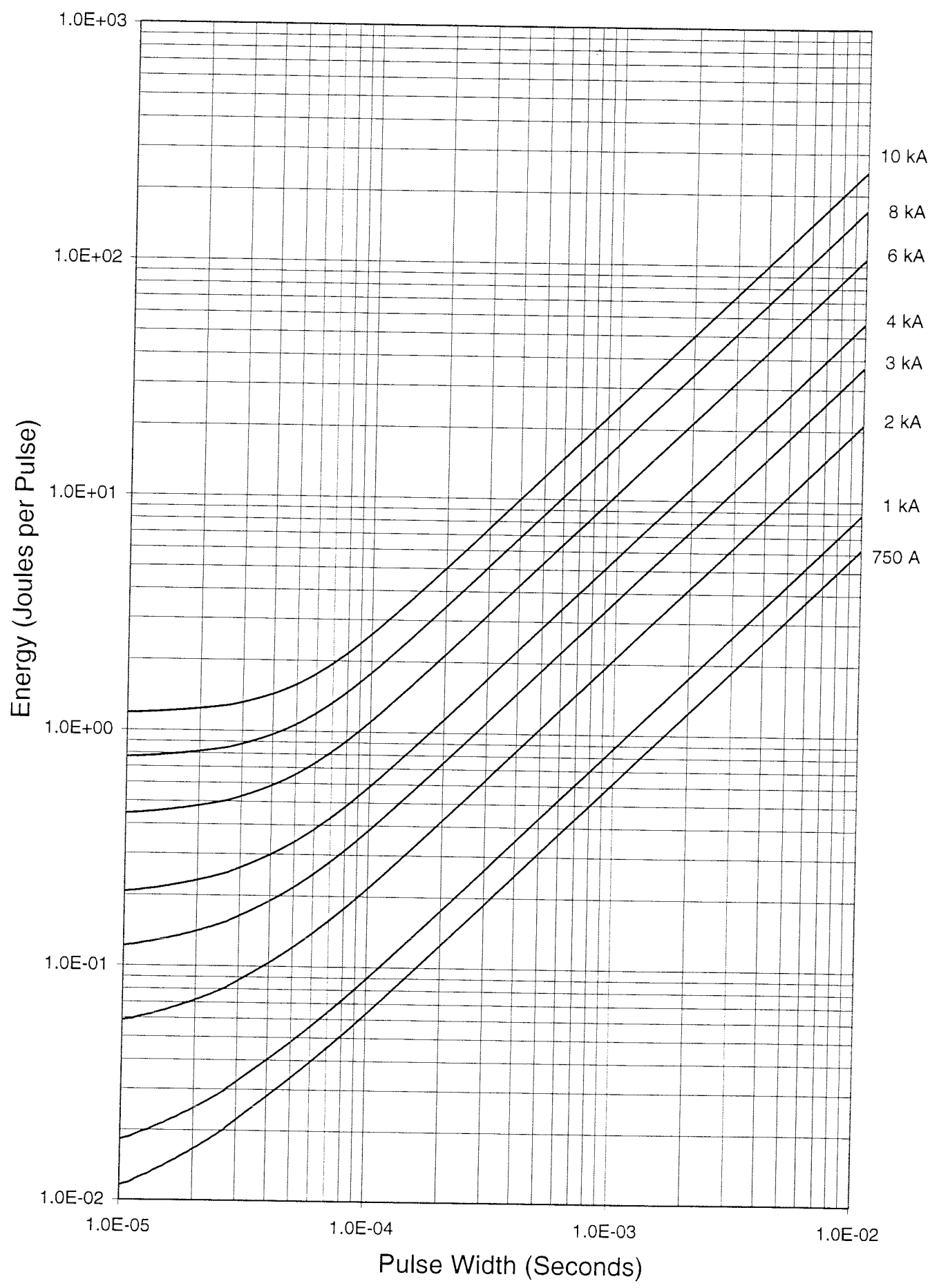
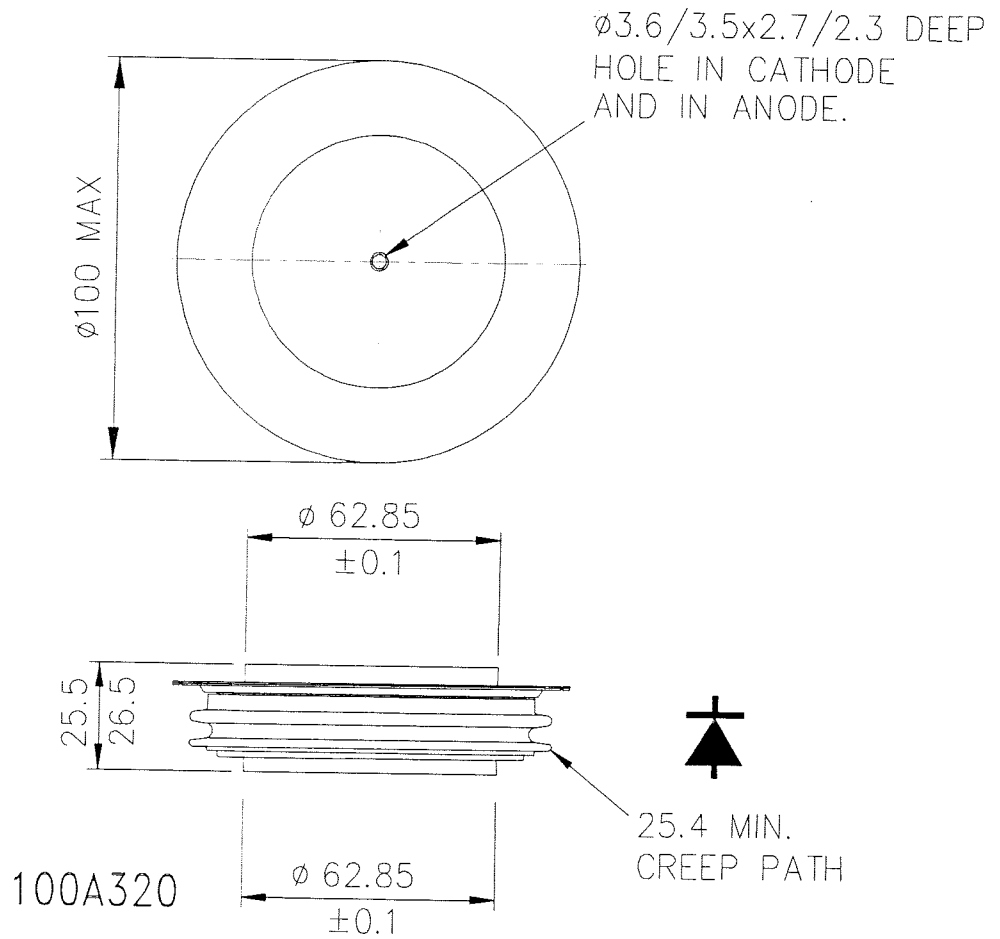

Fig. 19



**ORDERING INFORMATION**

(Please quote 10 digit code as below)

<b>SM</b>	◆ ◆	<b>FXC</b>	<b>394</b>
Fixed Type Code	Voltage Code 36 - 45	Clamp height 26.5	Fixed Type Code

Typical order code : SM38FXC394 :- 3800V  $V_{RRM}$ , 26.5mm Clamp height capsule.

**WESTCODE**   
**SEMICONDUCTORS**

U.K. : Westcode Semiconductors Ltd  
P.O. Box 57, Chippenham, Wiltshire, England SN15 1JL  
Tel: +44 (0)1249 444524 Fax: +44 (0)1249 659448  
E-mail: WSL.sales@btrinc.com

USA : Westcode Semiconductors Inc  
3270 Cherry Avenue, Long Beach, California 90807  
Tel: 310 595 6971 Fax: 310 595 8182

WWW: <http://www.westcode.com>

*A member of the BTR group.*

In the interest of Product improvement Westcode reserves the right to change specifications at any time without notice.

© Westcode Semiconductors Ltd