

**60A, 60V, 0.030 Ohm, ESD Rated,
P-Channel Power MOSFET**

The RFG60P06E P-Channel power MOSFET is manufactured using the MegaFET process. This process, which uses feature sizes approaching those of LSI circuits gives optimum utilization of silicon, resulting in outstanding performance. They were designed for use in applications such as switching regulators, switching converters, motor drivers and relay drivers. These transistors can be operated directly from integrated circuits.

The RFG60P06E incorporates ESD protection and is designed to withstand 2kV (Human Body Model) of ESD.

Formerly developmental type TA09836.

Ordering Information

PART NUMBER	PACKAGE	BRAND
RFG60P06E	TO-247	RFG60P06E

NOTE: When ordering use the entire part numberr RFG60P06E.

Features

- 60A, 60V
- $r_{DS(ON)} = 0.030\Omega$
- Temperature Compensating PSPICE® Model
- 2kV ESD Rated
- Peak Current vs Pulse Width Curve
- UIS Rating Curve
- 175°C Operating Temperature
- Related Literature

Symbol

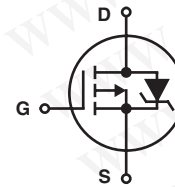

Packaging

JEDEC STYLE TO-247

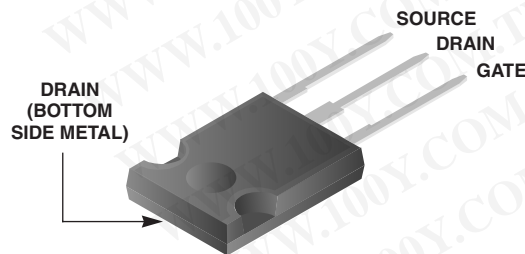

勝特力材料 886-3-5753170
 勝特力电子(上海) 86-21-34970699
 勝特力电子(深圳) 86-755-83298787
[Http://www.100y.com.tw](http://www.100y.com.tw)

RFG60P06E

勝特力材料 886-3-5753170
 勝特力电子(上海) 86-21-34970699
 勝特力电子(深圳) 86-755-83298787
[Http://www.100y.com.tw](http://www.100y.com.tw)

Absolute Maximum Ratings $T_C = 25^\circ\text{C}$

	RFG60P06E	UNITS
Drain to Source Voltage (Note 1)	V_{DSS} -60	V
Drain to Gate Voltage (Note 1)	V_{DGR} -60	V
Gate to Source Voltage	V_{GS} $\pm\pm 20$	V
Continuous Drain Current	I_D 60	A
Pulsed Drain Current (Note 3, Figure 5)	I_{DM} Refer to Peak Current Curve	
Single Pulse Avalanche Rating (Note 4)	E_{AS} Refer to UIS Curve	
Electrostatic Discharge Rating	E_{SD} 2	KV
MIL-STD-883, Category B(2)		
Power Dissipation	P_D 215	W
Derate Above 25°C	1.43	W/ $^\circ\text{C}$
Operating and Storage Temperature	T_J, T_{STG} -55 to 175	$^\circ\text{C}$
Maximum Temperature for Soldering		
Leads at 0.063in (1.6mm) from Case for 10s	T_L 300	$^\circ\text{C}$
Package Body for 10s, See Techbrief 334	T_{pkg} 260	$^\circ\text{C}$

CAUTION: Stresses above those listed in "Absolute Maximum Ratings" may cause permanent damage to the device. This is a stress only rating and operation of the device at these or any other conditions above those indicated in the operational sections of this specification is not implied.

NOTE:

- $T_J = 25^\circ\text{C}$ to 150°C .

Electrical Specifications $T_C = 25^\circ\text{C}$, Unless Otherwise Specified

PARAMETER	SYMBOL	TEST CONDITIONS	MIN	TYP	MAX	UNITS	
Drain to Source Breakdown Voltage	BV_{DSS}	$I_D = 250\mu\text{A}, V_{GS} = 0\text{V}$	-60	-	-	V	
Gate To Threshold Voltage	$V_{GS(TH)}$	$V_{GS} = V_{DS}, I_D = 250\mu\text{A}$	-2	-	-4	V	
Zero Gate Voltage Drain Current	I_{DSS}	$V_{DS} = -60\text{V}, V_{GS} = 0\text{V}$	$T_C = 25^\circ\text{C}$	-	-	-1	μA
			$T_C = 150^\circ\text{C}$	-	-	-50	μA
Gate to Source Leakage Current	I_{GSS}	$V_{GS} = \pm 20\text{V}$	-	-	100	nA	
Drain to Source On Resistance	$r_{DS(ON)}$	$I_D = 60\text{A}, V_{GS} = -10\text{V}$	-	-	0.030	Ω	
Turn-On Time	t_{ON}	$V_{DD} = -30\text{V}, I_D = 30\text{A}, R_L = 1.0\Omega, V_{GS} = -10\text{V}, R_{GS} = 2.5\Omega$	-	-	125	ns	
Turn-On Delay Time	$t_{d(ON)}$		-	20	-	ns	
Rise Time	t_r		-	60	-	ns	
Turn-Off Delay Time	$t_{d(OFF)}$		-	65	-	ns	
Fall Time	t_f		-	20	-	ns	
Turn-Off Time	t_{OFF}		-	-	125	ns	
Total Gate Charge	$Q_g(TOT)$	$V_{GS} = 0$ to -20V	$V_{DD} = -48\text{V}, I_D = 60\text{A}, R_L = 0.8\Omega$	-	-	450	nC
Gate Charge at -10V	$Q_g(-10)$	$V_{GS} = 0$ to -10V		-	-	225	nC
Threshold Gate Charge	$Q_g(TH)$	$V_{GS} = 0$ to -2V		-	-	15	nC
Input Capacitance	C_{ISS}	$V_{DS} = -25\text{V}, V_{GS} = 0\text{V}, f = 1\text{MHz}$	-	7200	-	pF	
Output Capacitance	C_{OSS}		-	1700	-	pF	
Reverse Transfer Capacitance	C_{RSS}		-	325	-	pF	
Thermal Resistance Junction to Case	$R_{\theta JC}$		-	-	0.70	$^\circ\text{C/W}$	
Thermal Resistance Junction to Ambient	$R_{\theta JA}$		-	-	80	$^\circ\text{C/W}$	

Source to Drain Diode Specifications

PARAMETER	SYMBOL	TEST CONDITIONS	MIN	TYP	MAX	UNITS
Source to Drain Diode Voltage	V_{SD}	$I_{SD} = 45\text{A}$	-	-	1.5	V
Diode Reverse Recovery Time	t_{rr}	$I_{SD} = 45\text{A}, di_{SD}/dt = 100\text{A}/\mu\text{s}$	-	-	125	ns

NOTES:

- Pulse test: pulse width $\leq 300\mu\text{s}$ maximum, duty cycle $\leq 2\%$.
- Repetitive rating: pulse width limited by maximum junction temperature. See Transient Thermal Impedance curve (Figure 3).

Typical Performance Curves Unless Otherwise Specified

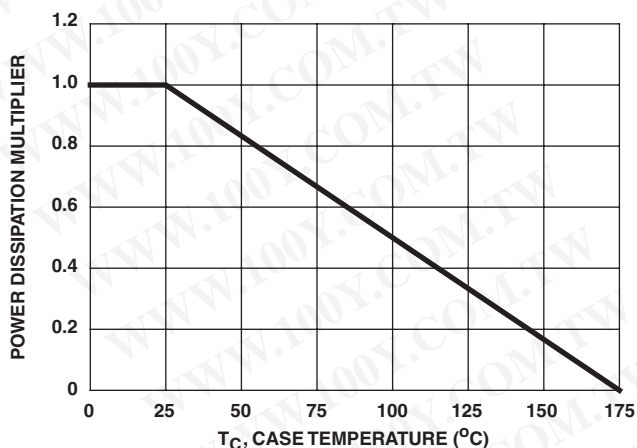

FIGURE 1. NORMALIZED POWER DISSIPATION vs CASE TEMPERATURE

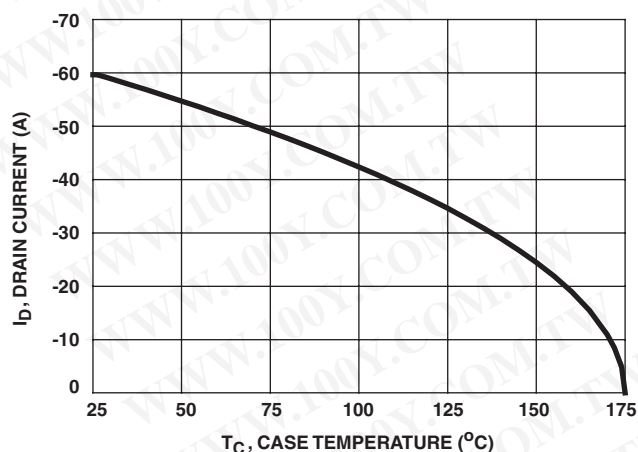

FIGURE 2. MAXIMUM CONTINUOUS DRAIN CURRENT vs CASE TEMPERATURE

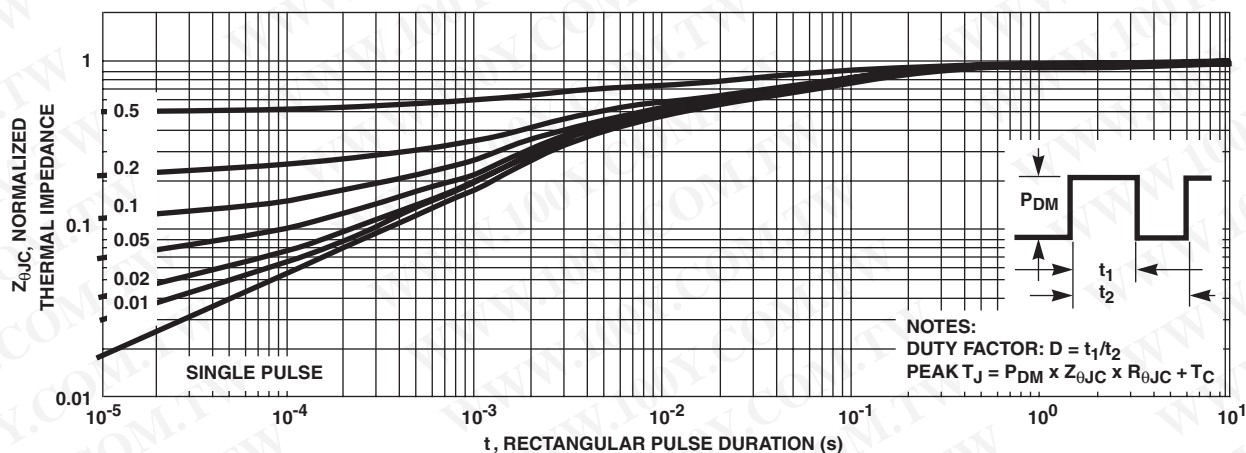

FIGURE 3. NORMALIZED MAXIMUM TRANSIENT THERMAL IMPEDANCE

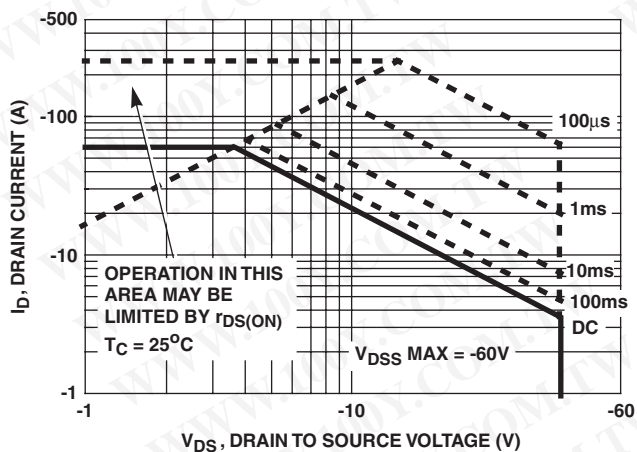

FIGURE 4. FORWARD BIAS SAFE OPERATING AREA

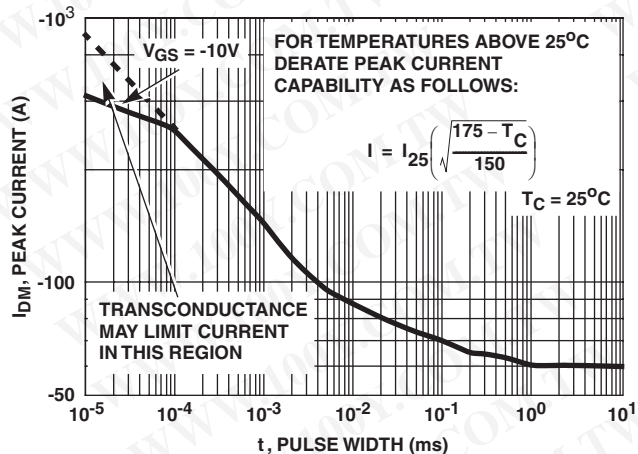

FIGURE 5. PEAK CURRENT CAPABILITY

Typical Performance Curves Unless Otherwise Specified (Continued)

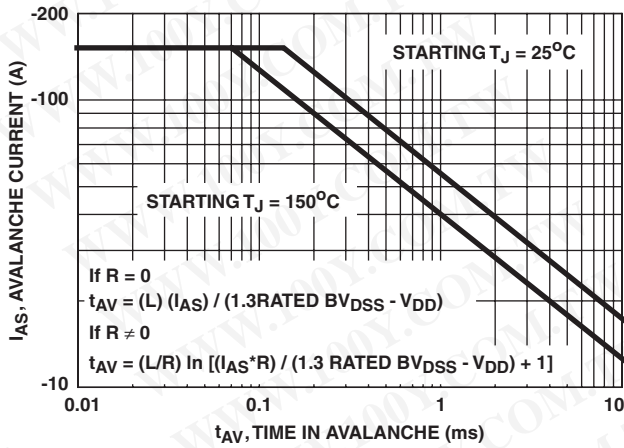

FIGURE 6. UNCLAMPED INDUCTIVE SWITCHING

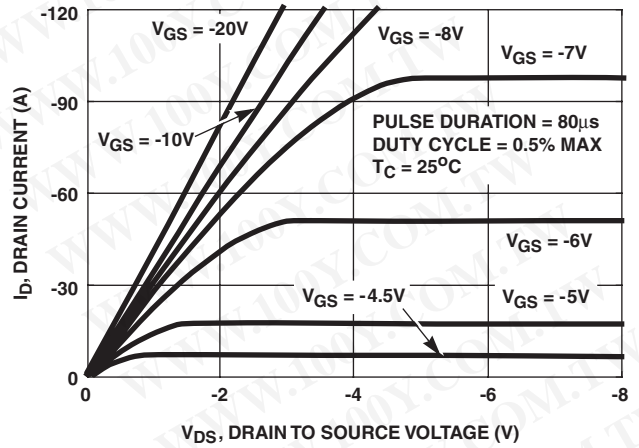

FIGURE 7. SATURATION CHARACTERISTICS

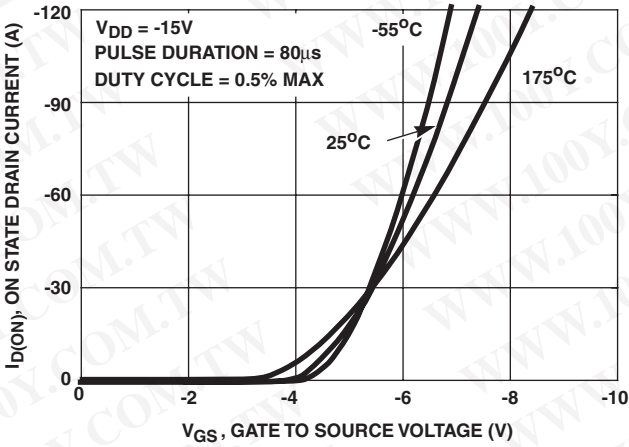

FIGURE 8. TRANSFER CHARACTERISTICS

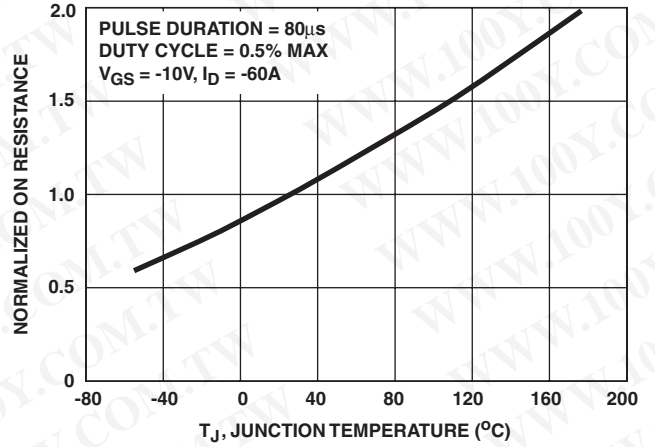

FIGURE 9. NORMALIZED DRAIN TO SOURCE ON RESISTANCE vs JUNCTION TEMPERATURE

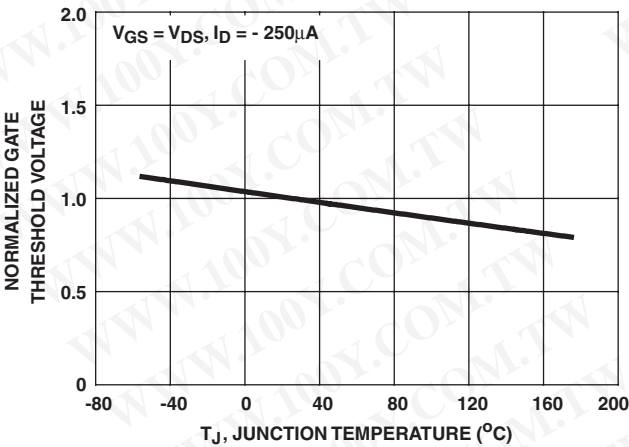

FIGURE 10. NORMALIZED GATE THRESHOLD VOLTAGE vs JUNCTION TEMPERATURE

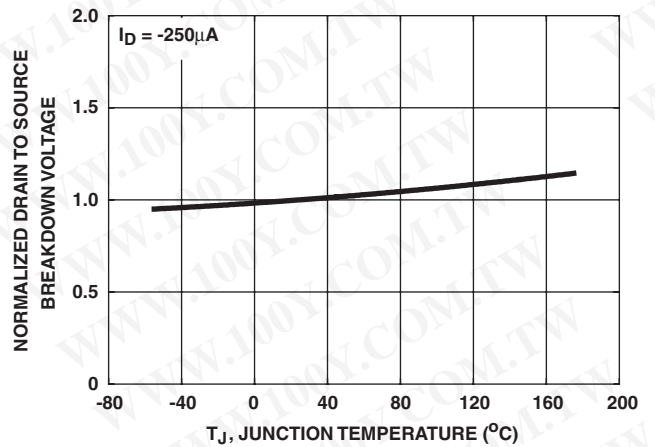

FIGURE 11. NORMALIZED DRAIN TO SOURCE BREAKDOWN VOLTAGE vs JUNCTION TEMPERATURE

Typical Performance Curves Unless Otherwise Specified (Continued)

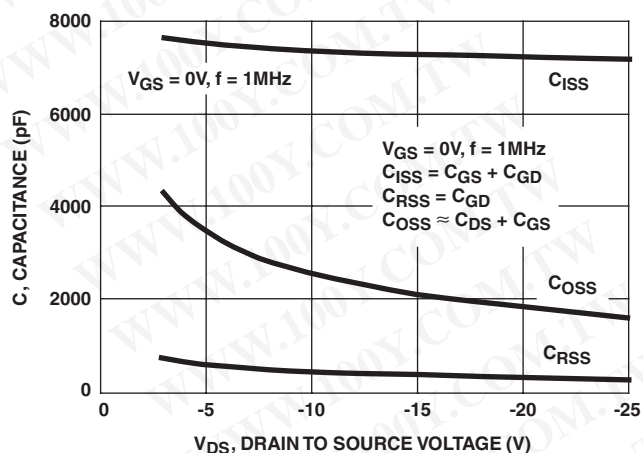
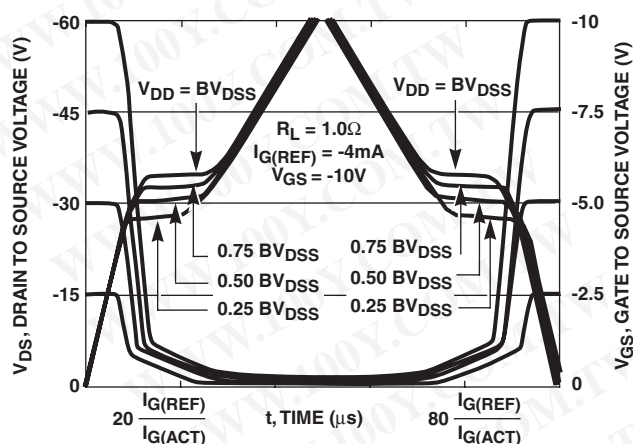

FIGURE 12. CAPACITANCE vs DRAIN TO SOURCE VOLTAGE



NOTE: Refer to Fairchild Application Notes AN7254 and AN7260.

FIGURE 13. NORMALIZED SWITCHING WAVEFORMS FOR CONSTANT GATE CURRENT

Test Circuits and Waveforms

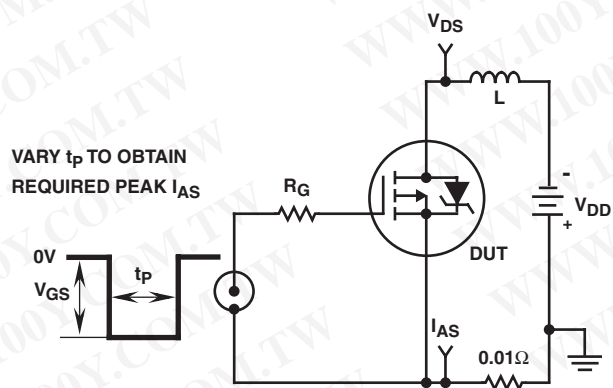

FIGURE 14. UNCLAMPED ENERGY TEST CIRCUIT

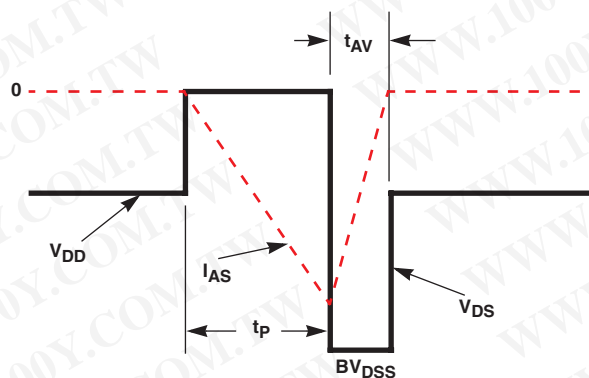

FIGURE 15. UNCLAMPED ENERGY WAVEFORMS

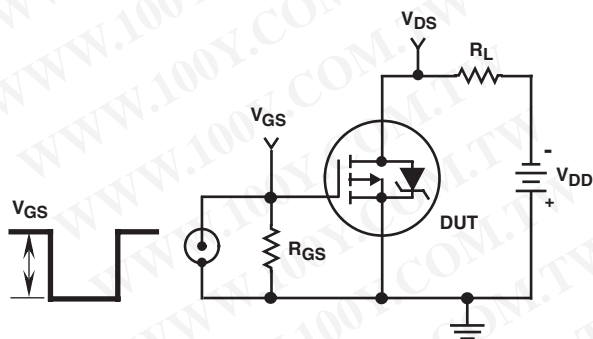

FIGURE 16. SWITCHING TIME TEST CIRCUIT

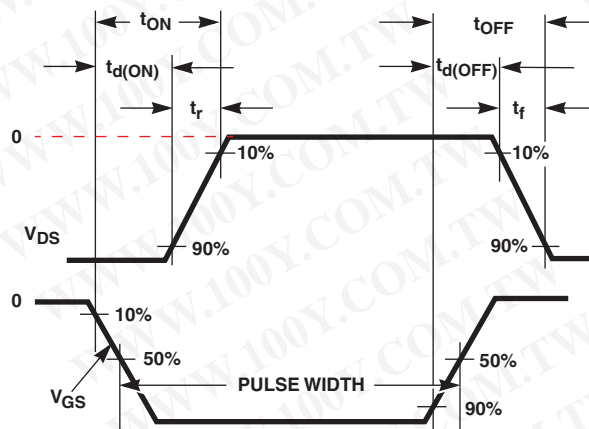

FIGURE 17. RESISTIVE SWITCHING WAVEFORMS

Test Circuits and Waveforms (Continued)

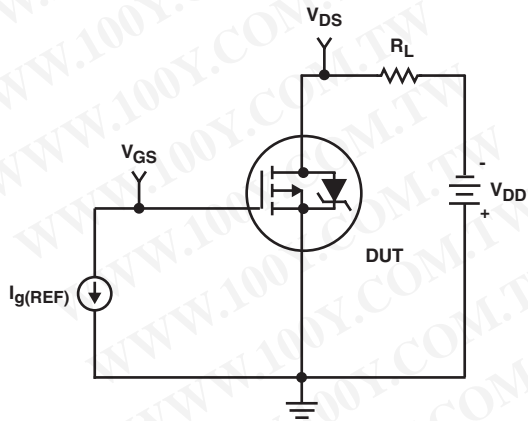

FIGURE 18. GATE CHARGE TEST CIRCUIT

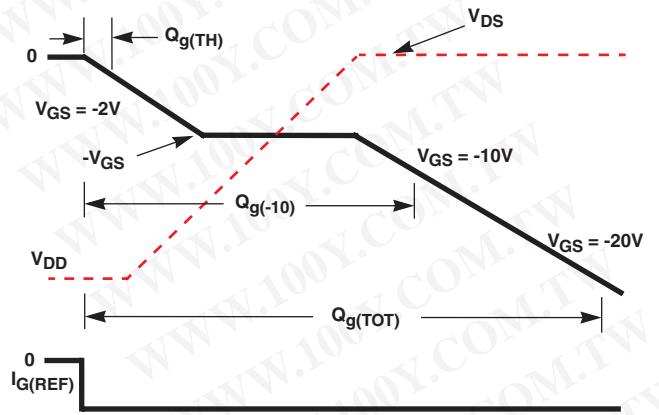

FIGURE 19. GATE CHARGE WAVEFORMS

勝特力材料 886-3-5753170
 勝特力电子(上海) 86-21-34970699
 勝特力电子(深圳) 86-755-83298787
[Http://www.100y.com.tw](http://www.100y.com.tw)

PSpICE Electrical Model

.SUBCKT RFG60P06E 2 1 3; REV 9/20/94

CA 12 8 1.01e-8
 CB 15 14 1.05e-8
 CIN 6 8 6.9e-9

DBODY 5 7 DBDMOD
 DBREAK 7 11 DBKMOD
 DPLCAP 10 6 DPLCAPMOD

EBREAK 5 11 17 18 -76.35
 EDS 14 8 5 8 1
 EGS 13 8 6 8 1
 ESG 5 10 8 6 1
 EVTO 20 6 8 18 1

IT 8 17 1

LDRAIN 2 5 1e-9
 LGATE 1 9 7.9e-9
 LSOURCE 3 7 4.18e-9

MOS1 16 6 8 8 MOSMOD M=0.99
 MOS2 16 21 8 8 MOSMOD M=0.01

RBREAK 17 18 RBKMOD 1
 RDRAIN 5 16 RDSMOD 12.83e-3
 RGATE 9 20 1.5
 RIN 6 8 1e9
 RSOURCE 8 7 RDSMOD 3.25e-3
 RVTO 18 19 RVTOMOD 1

S1A 6 12 13 8 S1AMOD
 S1B 13 12 13 8 S1BMOD
 S2A 6 15 14 13 S2AMOD
 S2B 13 15 14 13 S2BMOD

VBAT 8 19 DC 1
 VTO 21 6 -0.83

.MODEL DBDMOD D (IS=1.24e-12 RS=4.72e-3 TRS1=1.43e-3 TRS2=-4.91e-7 CJO=6.98e-9 TT=1.5e-7)
 .MODEL DBKMOD D (RS=1.11e-1 TRS1=1.34e-3 TRS2=4.46e-12)
 .MODEL DPLCAPMOD D (CJO=15e-10 IS=1e-30 N=10)
 .MODEL MOSMOD PMOS (VTO=-3.71 KP=31.5 IS=1e-30 N=10 TOX=1 L=1u W=1u)
 .MODEL RBKMOD RES (TC1=9.42e-4 TC2=0)
 .MODEL RDSMOD RES (TC1=5.85e-3 TC2=7.69e-6)
 .MODEL RVTOMOD RES (TC1=-3.39e-3 TC2=1.07e-6)
 .MODEL S1AMOD VSWITCH (RON=1e-5 ROFF=0.1 VON=4.6 VOFF=2.6)
 .MODEL S1BMOD VSWITCH (RON=1e-5 ROFF=0.1 VON=2.6 VOFF=4.6)
 .MODEL S2AMOD VSWITCH (RON=1e-5 ROFF=0.1 VON=1.16 VOFF=-3.84)
 .MODEL S2BMOD VSWITCH (RON=1e-5 ROFF=0.1 VON=-3.84 VOFF=1.16)

.ENDS

NOTE: For further discussion of the PSpICE model, consult **A New PSpICE Sub-Circuit for the Power MOSFET Featuring Global Temperature Options**; written by William J. Hepp and C. Frank Wheatley.

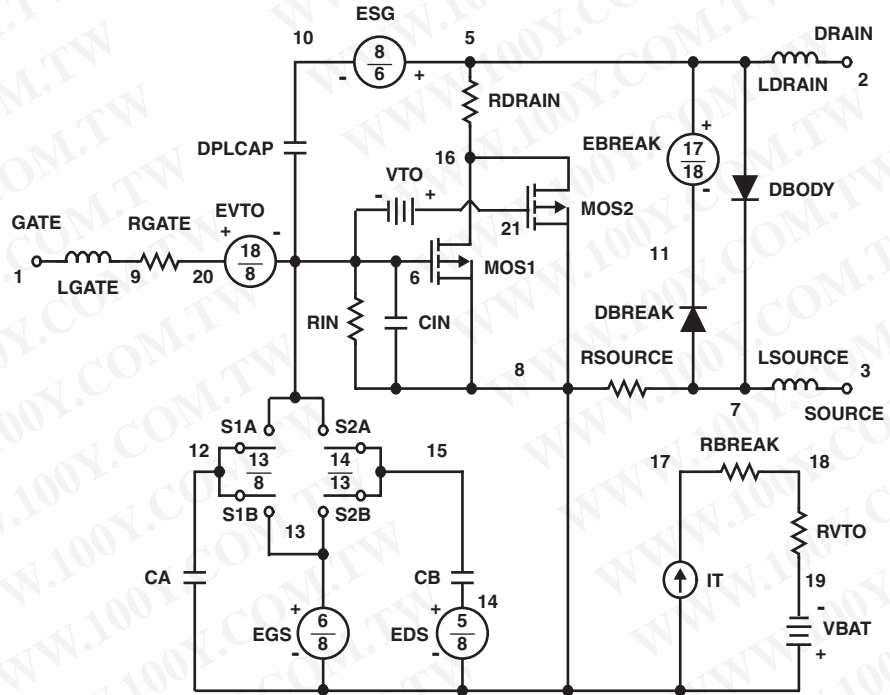

勝特力材料 886-3-5753170
 勝特力电子(上海) 86-21-34970699
 勝特力电子(深圳) 86-755-83298787
[Http://www.100y.com.tw](http://www.100y.com.tw)

TRADEMARKS

The following are registered and unregistered trademarks Fairchild Semiconductor owns or is authorized to use and is not intended to be an exhaustive list of all such trademarks.

ACE _x TM	FAST [®]	OPTOLOGIC TM	SMART START TM	VCX TM
Bottomless TM	FAST _r TM	OPTOPLANAR TM	STAR*POWER TM	
CoolFET TM	FRFET TM	PACMAN TM	Stealth TM	
CROSSVOLT TM	GlobalOptoisolator TM	POPT TM	SuperSOT TM -3	
DenseTrench TM	GTO TM	Power247 TM	SuperSOT TM -6	
DOMET TM	HiSeC TM	PowerTrench [®]	SuperSOT TM -8	
EcoSPARK TM	ISOPLANAR TM	QFET TM	SyncFET TM	
E ² CMOS TM	LittleFET TM	QST TM	TinyLogic TM	
EnSigna TM	MicroFET TM	QT Optoelectronics TM	TruTranslation TM	
FACT TM	MicroPak TM	Quiet Series TM	UHC TM	
FACT Quiet Series TM	MICROWIRE TM	SILENT SWITCHER [®]	UltraFET [®]	

STAR*POWER is used under license

DISCLAIMER

FAIRCHILD SEMICONDUCTOR RESERVES THE RIGHT TO MAKE CHANGES WITHOUT FURTHER NOTICE TO ANY PRODUCTS HEREIN TO IMPROVE RELIABILITY, FUNCTION OR DESIGN. FAIRCHILD DOES NOT ASSUME ANY LIABILITY ARISING OUT OF THE APPLICATION OR USE OF ANY PRODUCT OR CIRCUIT DESCRIBED HEREIN; NEITHER DOES IT CONVEY ANY LICENSE UNDER ITS PATENT RIGHTS, NOR THE RIGHTS OF OTHERS.

LIFE SUPPORT POLICY

FAIRCHILD'S PRODUCTS ARE NOT AUTHORIZED FOR USE AS CRITICAL COMPONENTS IN LIFE SUPPORT DEVICES OR SYSTEMS WITHOUT THE EXPRESS WRITTEN APPROVAL OF FAIRCHILD SEMICONDUCTOR CORPORATION.

As used herein:

1. Life support devices or systems are devices or systems which, (a) are intended for surgical implant into the body, or (b) support or sustain life, or (c) whose failure to perform when properly used in accordance with instructions for use provided in the labeling, can be reasonably expected to result in significant injury to the user.
2. A critical component is any component of a life support device or system whose failure to perform can be reasonably expected to cause the failure of the life support device or system, or to affect its safety or effectiveness.

PRODUCT STATUS DEFINITIONS

Definition of Terms

Datasheet Identification	Product Status	Definition
Advance Information	Formative or In Design	This datasheet contains the design specifications for product development. Specifications may change in any manner without notice.
Preliminary	First Production	This datasheet contains preliminary data, and supplementary data will be published at a later date. Fairchild Semiconductor reserves the right to make changes at any time without notice in order to improve design.
No Identification Needed	Full Production	This datasheet contains final specifications. Fairchild Semiconductor reserves the right to make changes at any time without notice in order to improve design.
Obsolete	Not In Production	This datasheet contains specifications on a product that has been discontinued by Fairchild semiconductor. The datasheet is printed for reference information only.