

# PowerMOS transistor

# PHD6N10E

## GENERAL DESCRIPTION

N-channel enhancement mode field-effect power transistor in a plastic envelope suitable for surface mounting featuring high avalanche energy capability, stable blocking voltage, fast switching and high thermal cycling performance with low thermal resistance. Intended for use in Switched Mode Power Supplies (SMPS), motor control circuits and general purpose switching applications.

## QUICK REFERENCE DATA

SYMBOL	PARAMETER	MAX.	UNIT
$V_{DS}$	Drain-source voltage	100	V
$I_D$	Drain current (DC)	6.3	A
$P_{tot}$	Total power dissipation	50	W
$R_{DS(ON)}$	Drain-source on-state resistance	0.54	$\Omega$

## PINNING - SOT428

PIN	DESCRIPTION
1	gate
2	drain
3	source
tab	drain

## PIN CONFIGURATION

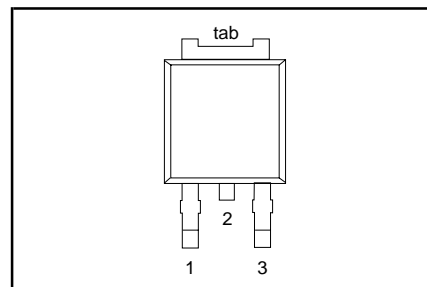

## SYMBOL

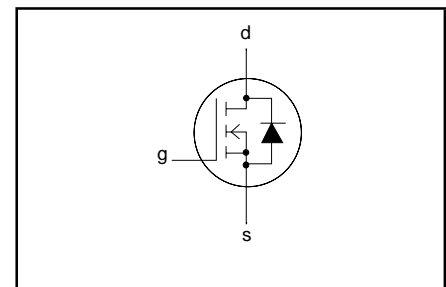

## LIMITING VALUES

Limiting values in accordance with the Absolute Maximum System (IEC 134)

SYMBOL	PARAMETER	CONDITIONS	MIN.	MAX.	UNIT
$I_D$	Continuous drain current	$T_{mb} = 25\text{ }^\circ\text{C}; V_{GS} = 10\text{ V}$	-	6.3	A
$I_{DM}$	Pulsed drain current	$T_{mb} = 100\text{ }^\circ\text{C}; V_{GS} = 10\text{ V}$	-	4.5	A
$P_D$	Total dissipation	$T_{mb} = 25\text{ }^\circ\text{C}$	-	25	W
$\Delta P_D / \Delta T_{mb}$	Linear derating factor	$T_{mb} = 25\text{ }^\circ\text{C}$	-	50	W
$V_{GS}$	Gate-source voltage	$T_{mb} > 25\text{ }^\circ\text{C}$	-	0.33	W/K
$E_{AS}$	Single pulse avalanche energy	$V_{DD} \leq 50\text{ V}; \text{ starting } T_j = 25\text{ }^\circ\text{C}; R_{GS} = 50\text{ } \Omega;$ $V_{GS} = 10\text{ V}$	-	$\pm 30$	V
$I_{AS}$	Peak avalanche current	$V_{DD} \leq 50\text{ V}; \text{ starting } T_j = 25\text{ }^\circ\text{C}; R_{GS} = 50\text{ } \Omega;$ $V_{GS} = 10\text{ V}$	-	30	mJ
$T_j, T_{stg}$	Operating junction and storage temperature range		-55	175	$^\circ\text{C}$

## THERMAL RESISTANCES

SYMBOL	PARAMETER	CONDITIONS	TYP.	MAX.	UNIT
$R_{th\ j-mb}$	Thermal resistance junction to mounting base		-	3	K/W
$R_{th\ j-a}$	Thermal resistance junction to ambient	pcb mounted, minimum footprint	50	-	K/W

## PowerMOS transistor

PHD6N10E

**ELECTRICAL CHARACTERISTICS** $T_j = 25\text{ }^\circ\text{C}$  unless otherwise specified

SYMBOL	PARAMETER	CONDITIONS	MIN.	TYP.	MAX.	UNIT
$V_{(BR)DSS}$	Drain-source breakdown voltage	$V_{GS} = 0\text{ V}; I_D = 0.25\text{ mA}$	100	-	-	V
$\frac{\Delta V_{(BR)DSS}}{\Delta T_j}$	Drain-source breakdown voltage temperature coefficient	$V_{DS} = V_{GS}; I_D = 0.25\text{ mA}$	-	0.15	-	V/K
$R_{DS(ON)}$	Drain-source on resistance	$V_{GS} = 10\text{ V}; I_D = 3.4\text{ A}$	-	0.25	0.54	$\Omega$
$V_{GS(TO)}$	Gate threshold voltage	$V_{DS} = V_{GS}; I_D = 0.25\text{ mA}$	2.0	3.0	4.0	V
$g_{fs}$	Forward transconductance	$V_{DS} = 50\text{ V}; I_D = 3.4\text{ A}$	1.3	3.0	-	S
$I_{DSS}$	Drain-source leakage current	$V_{DS} = 100\text{ V}; V_{GS} = 0\text{ V}$	-	0.1	25	$\mu\text{A}$
$I_{GSS}$	Gate-source leakage current	$V_{DS} = 80\text{ V}; V_{GS} = 0\text{ V}; T_j = 150\text{ }^\circ\text{C}$ $V_{GS} = \pm 30\text{ V}; V_{DS} = 0\text{ V}$	-	1	250	$\mu\text{A}$
$Q_{g(tot)}$	Total gate charge	$I_D = 5.6\text{ A}; V_{DD} = 80\text{ V}; V_{GS} = 10\text{ V}$	-	9.2	12	nC
$Q_{gs}$	Gate-source charge		-	1.7	3	nC
$Q_{gd}$	Gate-drain (Miller) charge		-	4.7	6	nC
$t_{d(on)}$	Turn-on delay time	$V_{DD} = 50\text{ V}; I_D = 5.6\text{ A};$ $R_G = 24\text{ }\Omega; R_D = 8.4\text{ }\Omega$	-	7	-	ns
$t_r$	Turn-on rise time		-	40	-	ns
$t_{d(off)}$	Turn-off delay time		-	22	-	ns
$t_f$	Turn-off fall time		-	18	-	ns
$L_d$	Internal drain inductance	Measured from tab to centre of die	-	3.5	-	nH
$L_s$	Internal source inductance	Measured from source lead solder point to source bond pad	-	7.5	-	nH
$C_{iss}$	Input capacitance	$V_{GS} = 0\text{ V}; V_{DS} = 25\text{ V}; f = 1\text{ MHz}$	-	222	-	pF
$C_{oss}$	Output capacitance		-	74	-	pF
$C_{rss}$	Feedback capacitance		-	30	-	pF

**SOURCE-DRAIN DIODE RATINGS AND CHARACTERISTICS** $T_j = 25\text{ }^\circ\text{C}$  unless otherwise specified

SYMBOL	PARAMETER	CONDITIONS	MIN.	TYP.	MAX.	UNIT
$I_S$	Continuous source current (body diode)	$T_{mb} = 25\text{ }^\circ\text{C}$	-	-	6.3	A
$I_{SM}$	Pulsed source current (body diode)	$T_{mb} = 25\text{ }^\circ\text{C}$	-	-	25	A
$V_{SD}$	Diode forward voltage	$I_S = 5.6\text{ A}; V_{GS} = 0\text{ V}$	-	-	1.5	V
$t_{rr}$	Reverse recovery time	$I_S = 5.6\text{ A}; V_{GS} = 0\text{ V};$ $di/dt = 100\text{ A}/\mu\text{s}$	-	70	-	ns
$Q_{rr}$	Reverse recovery charge		-	0.4	-	$\mu\text{C}$

PowerMOS transistor

PHD6N10E

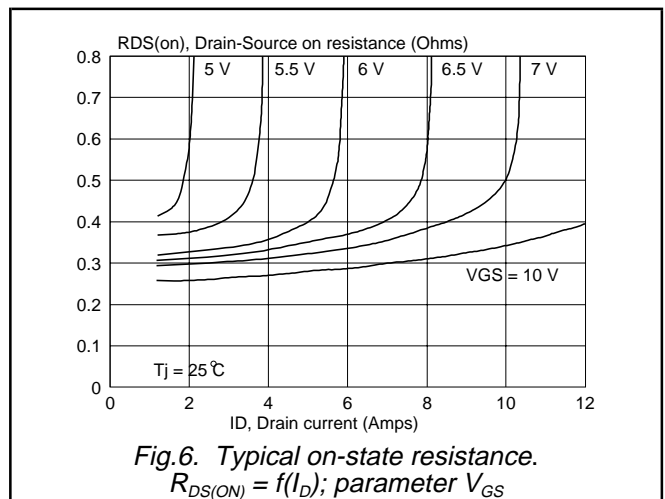
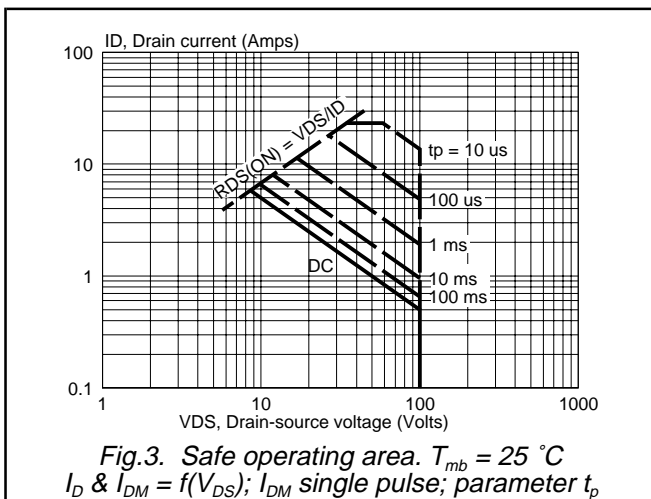
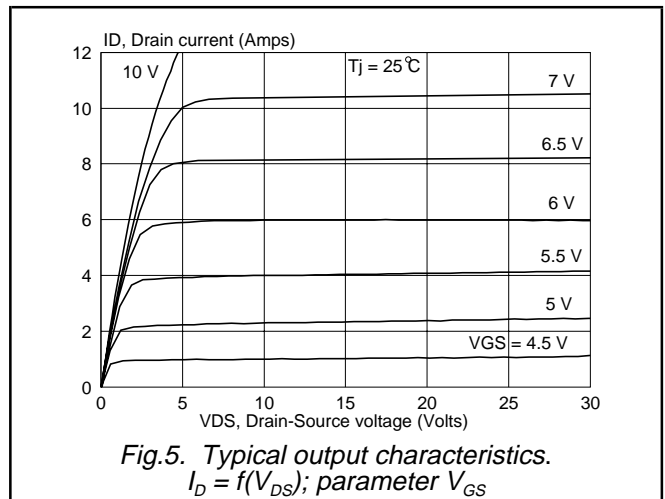
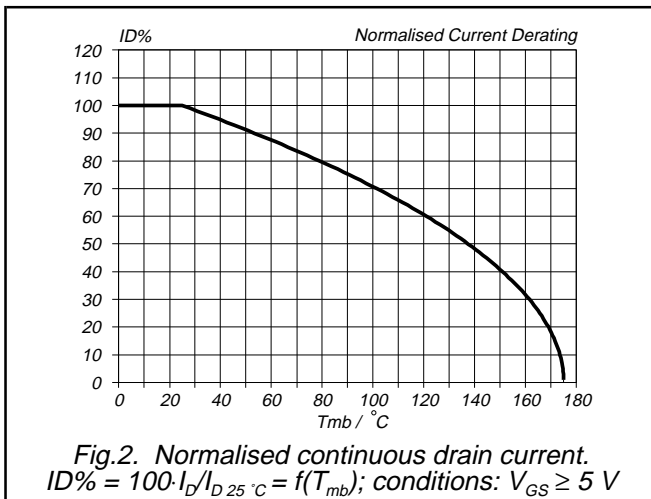
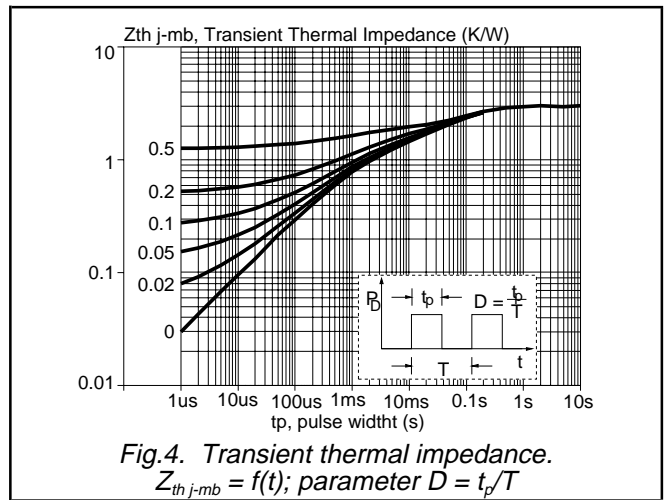
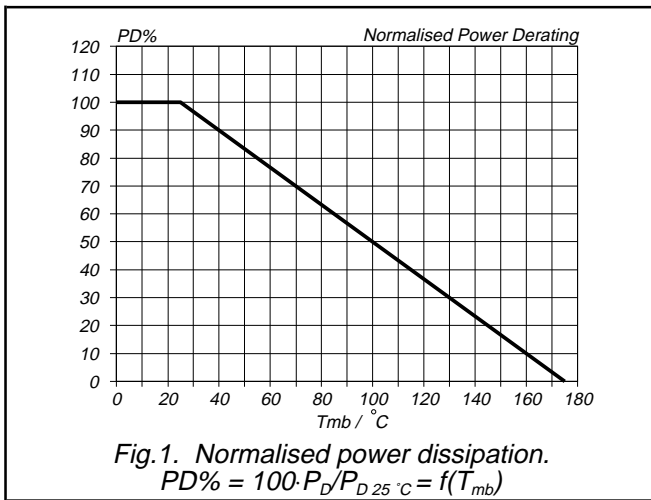

PowerMOS transistor

PHD6N10E

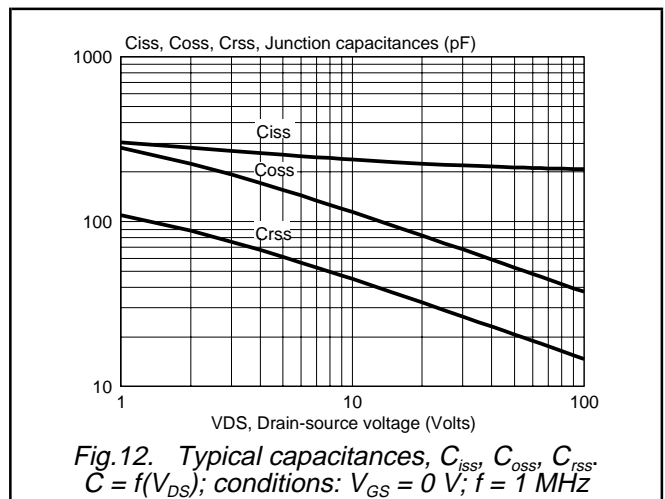
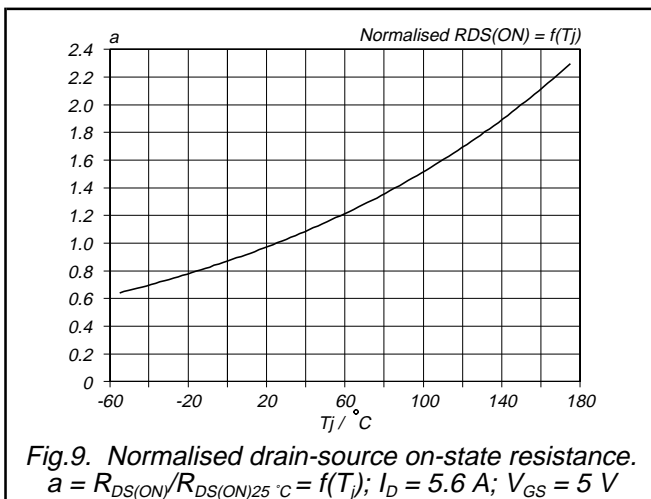
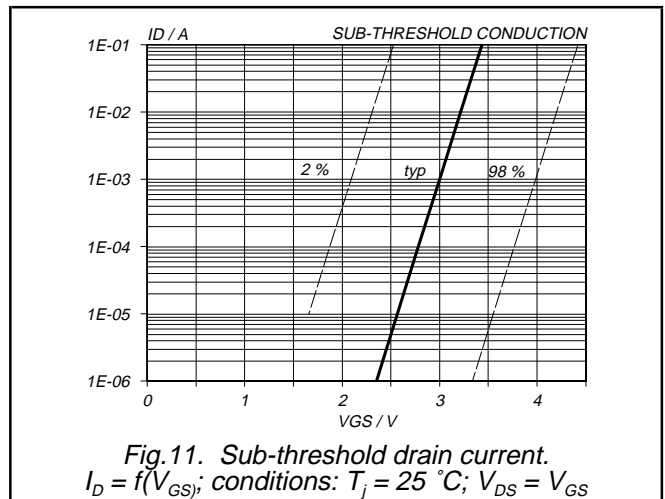
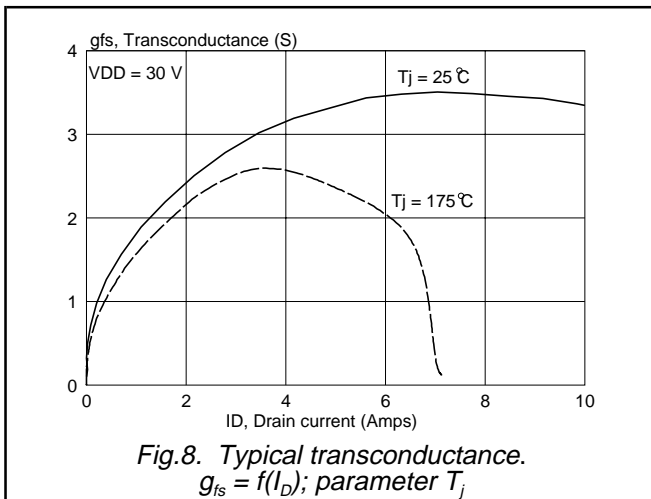
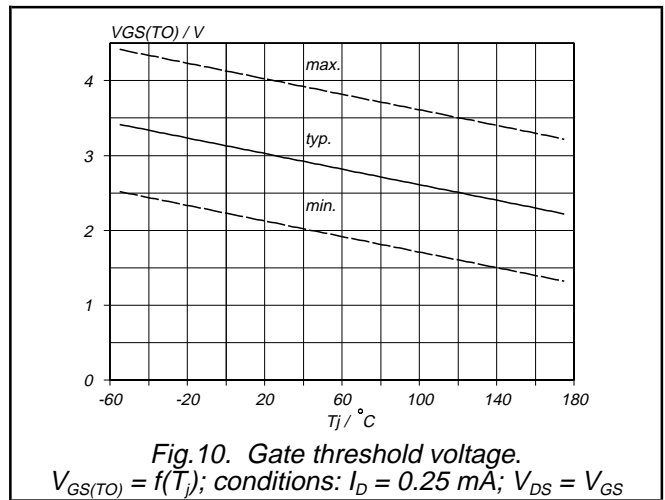
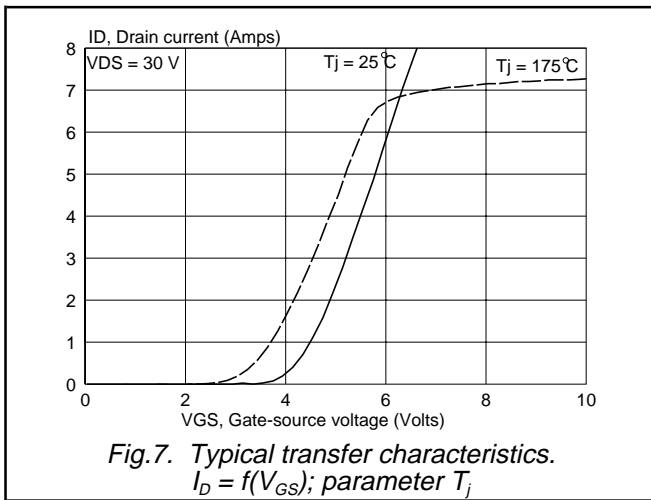

PowerMOS transistor

PHD6N10E

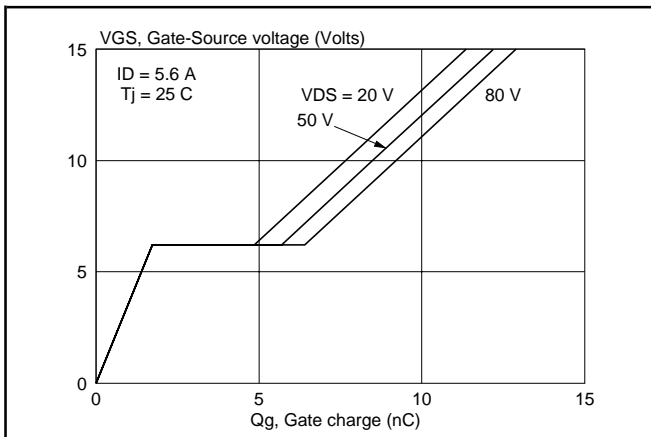

Fig.13. Typical turn-on gate-charge characteristics.  
 $V_{GS} = f(Q_G)$ ; parameter  $V_{DS}$

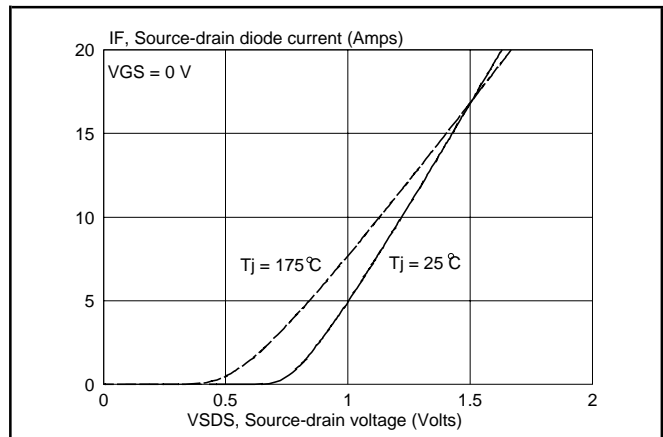

Fig.16. Source-Drain diode characteristic.  
 $I_F = f(V_{SDS})$ ; parameter  $T_j$

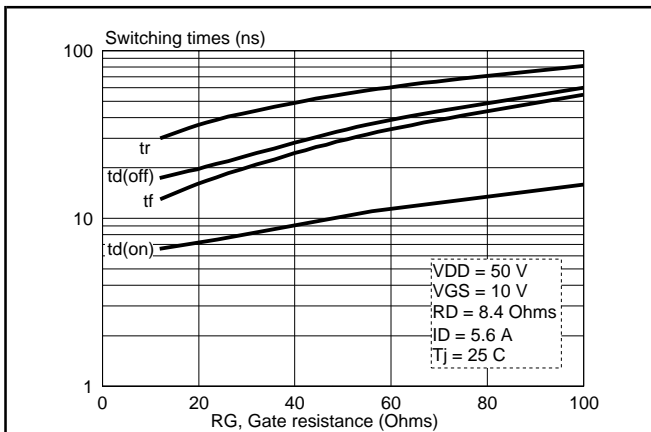

Fig.14. Normalised drain-source breakdown voltage.  
 $V_{(BR)DSS} / V_{(BR)DSS 25^\circ C} = f(T_j)$

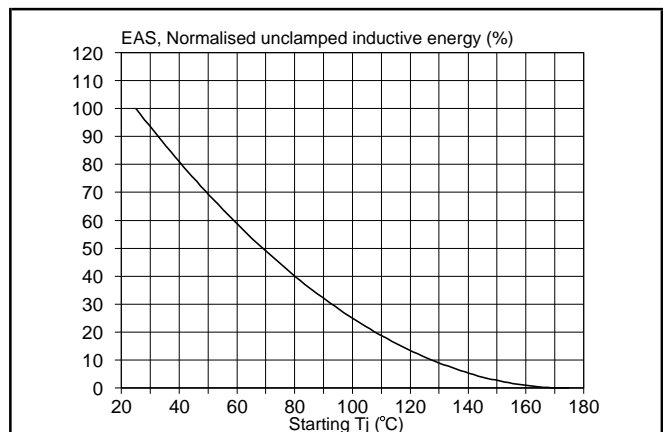

Fig.17. Normalised unclamped inductive energy.  
 $E_{AS} \% = f(T_j)$

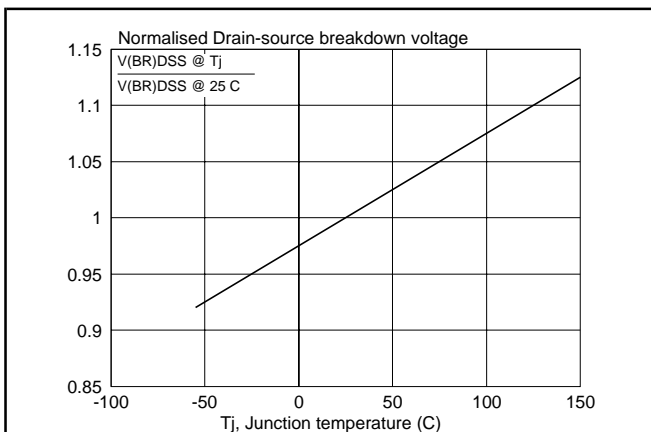

Fig.15. Normalised drain-source breakdown voltage.  
 $V_{(BR)DSS} / V_{(BR)DSS 25^\circ C} = f(T_j)$

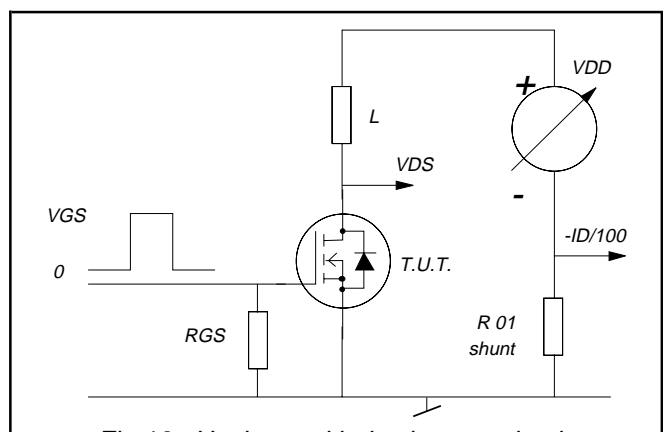
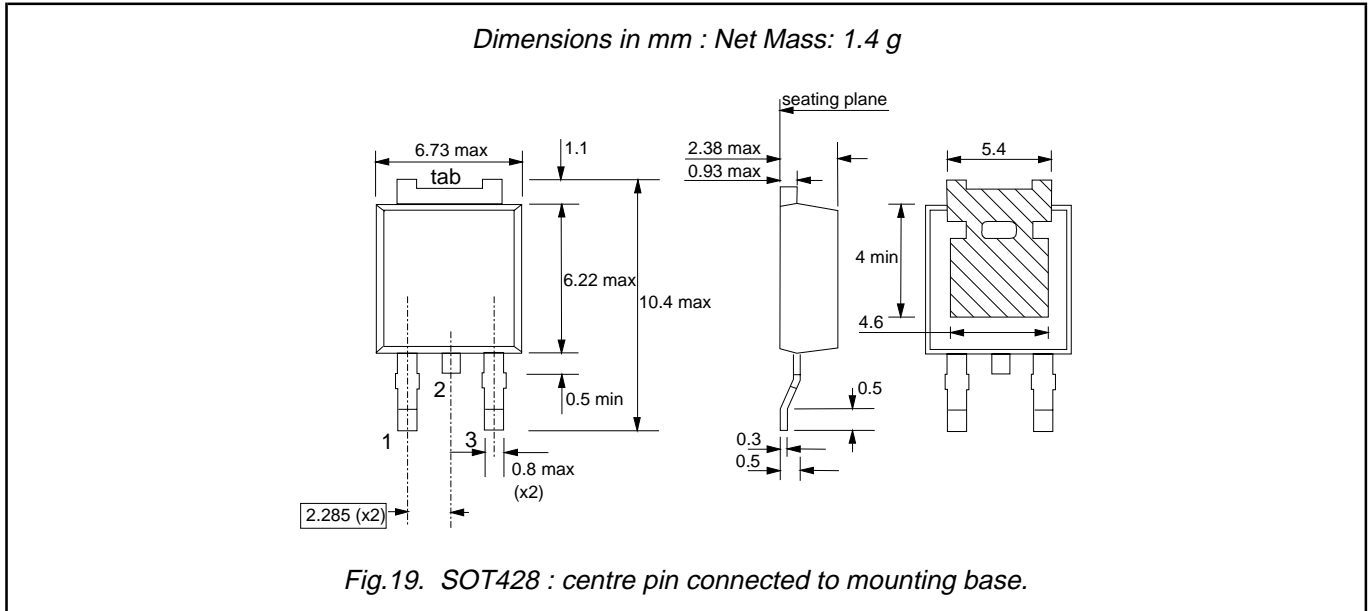
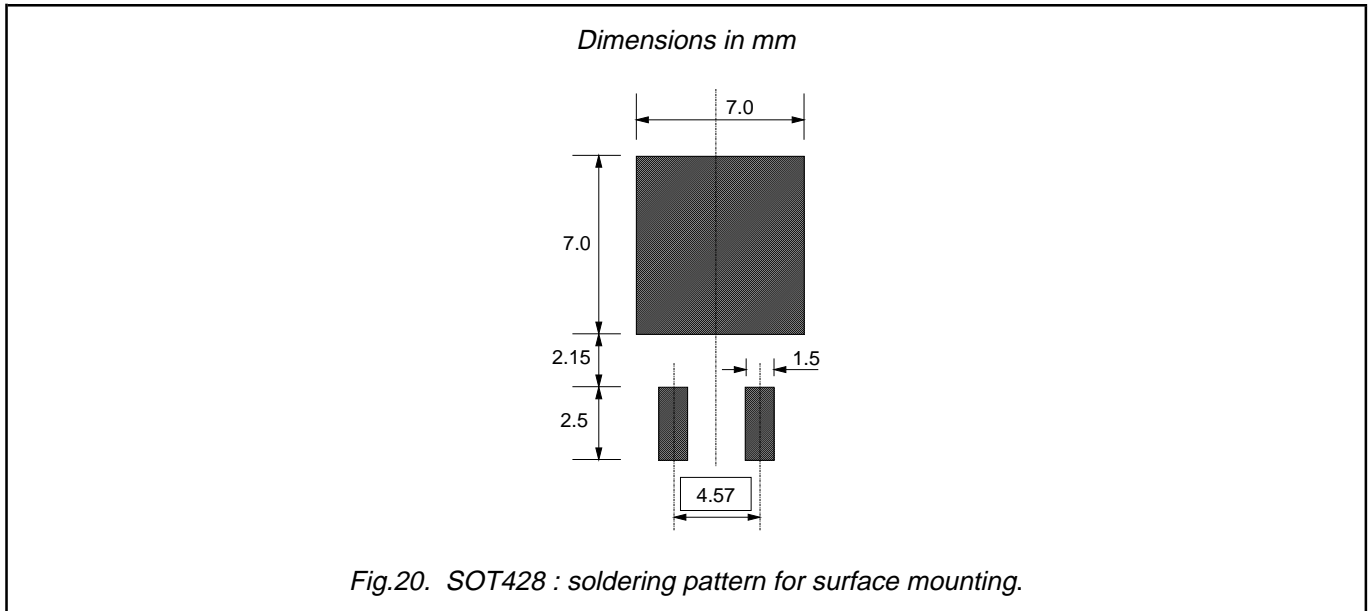

Fig.18. Unclamped inductive test circuit.  
 $E_{AS} = 0.5 \cdot L I_D^2 \cdot V_{(BR)DSS} / (V_{(BR)DSS} - V_{DD})$

**MECHANICAL DATA**



**MOUNTING INSTRUCTIONS**



**Notes**

1. Observe the general handling precautions for electrostatic-discharge sensitive devices (ESDs) to prevent damage to MOS gate oxide.
2. Epoxy meets UL94 V0 at 1/8".

## PowerMOS transistor

PHD6N10E

**DEFINITIONS**

<b>Data sheet status</b>	
Objective specification	This data sheet contains target or goal specifications for product development.
Preliminary specification	This data sheet contains preliminary data; supplementary data may be published later.
Product specification	This data sheet contains final product specifications.
<b>Limiting values</b>	
Limiting values are given in accordance with the Absolute Maximum Rating System (IEC 134). Stress above one or more of the limiting values may cause permanent damage to the device. These are stress ratings only and operation of the device at these or at any other conditions above those given in the Characteristics sections of this specification is not implied. Exposure to limiting values for extended periods may affect device reliability.	
<b>Application information</b>	
Where application information is given, it is advisory and does not form part of the specification.	
© Philips Electronics N.V. 1997	
All rights are reserved. Reproduction in whole or in part is prohibited without the prior written consent of the copyright owner.	
The information presented in this document does not form part of any quotation or contract, it is believed to be accurate and reliable and may be changed without notice. No liability will be accepted by the publisher for any consequence of its use. Publication thereof does not convey nor imply any license under patent or other industrial or intellectual property rights.	

**LIFE SUPPORT APPLICATIONS**

These products are not designed for use in life support appliances, devices or systems where malfunction of these products can be reasonably expected to result in personal injury. Philips customers using or selling these products for use in such applications do so at their own risk and agree to fully indemnify Philips for any damages resulting from such improper use or sale.