

**Features**

- | Advanced Process Technology
- | Ultra Low On-Resistance
- | Dynamic dv/dt Rating
- | 175°C Operating Temperature
- | Fast Switching
- | Repetitive Avalanche Allowed up to Tjmax

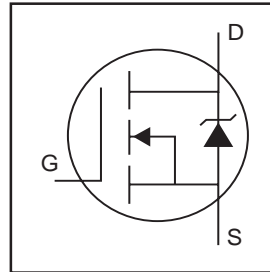

$V_{DSS} = 80V$
$R_{DS(on)} = 28m\Omega$
$I_D = 30A$

**Description**

Specifically designed for Automotive applications, this HEXFET® Power MOSFET utilizes the latest processing techniques to achieve extremely low on-resistance per silicon area. Additional features of this HEXFET power MOSFET are a 175°C junction operating temperature, low R $\theta$ JC, fast switching speed and improved repetitive avalanche rating. These features combine to make this design an extremely efficient and reliable device for use in Automotive applications and a wide variety of other applications.

The D-Pak is designed for surface mounting using vapor phase, infrared, or wave soldering techniques. The straight lead version (IRFU series) is for through-hole mounting applications. Power dissipation levels up to 1.5 watts are possible in typical surface mount applications.

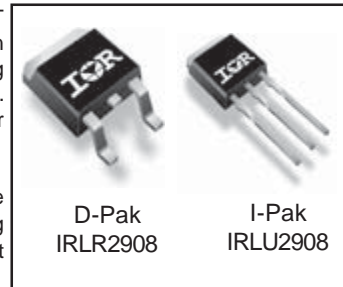

**Absolute Maximum Ratings**

	Parameter	Max.	Units
$I_D @ T_C = 25^\circ C$	Continuous Drain Current, $V_{GS} @ 10V$ (Silicon Limited)	39	A
$I_D @ T_C = 100^\circ C$	Continuous Drain Current, $V_{GS} @ 10V$ (See Fig. 9)	28	
$I_D @ T_C = 25^\circ C$	Continuous Drain Current, $V_{GS} @ 10V$ (Package Limited)	30	
$I_{DM}$	Pulsed Drain Current ①	150	
$P_D @ T_C = 25^\circ C$	Maximum Power Dissipation	120	W
	Linear Derating Factor	0.77	W/°C
$V_{GS}$	Gate-to-Source Voltage	$\pm 16$	V
$E_{AS}$	Single Pulse Avalanche Energy (Thermally Limited) ②	180	mJ
$E_{AS} (tested)$	Single Pulse Avalanche Energy Tested Value ⑦	250	
$I_{AR}$	Avalanche Current ①	See Fig.12a,12b,15,16	A
$E_{AR}$	Repetitive Avalanche Energy ⑥		mJ
dv/dt	Peak Diode Recovery dv/dt ③	2.3	V/ns
$T_J$	Operating Junction and	-55 to + 175	°C
$T_{STG}$	Storage Temperature Range		
	Soldering Temperature, for 10 seconds	300 (1.6mm from case )	

**Thermal Resistance**

	Parameter	Typ.	Max.	Units
$R_{\theta JC}$	Junction-to-Case	—	1.3	°C/W
$R_{\theta JA}$	Junction-to-Ambient (PCB Mount) ⑧	—	40	
$R_{\theta JA}$	Junction-to-Ambient	—	110	

# IRLR2908/IRLU2908

International  
**IR** Rectifier

Static @  $T_J = 25^\circ\text{C}$  (unless otherwise specified)

	Parameter	Min.	Typ.	Max.	Units	Conditions
$V_{(BR)DSS}$	Drain-to-Source Breakdown Voltage	80	—	—	V	$V_{GS} = 0V, I_D = 250\mu A$
$\Delta BV_{DSS}/\Delta T_J$	Breakdown Voltage Temp. Coefficient	—	0.085	—	V/°C	Reference to $25^\circ\text{C}$ , $I_D = 1\text{mA}$
$R_{DS(on)}$	Static Drain-to-Source On-Resistance	—	22.5	28	mΩ	$V_{GS} = 10V, I_D = 23A$ ④
		—	25	30		$V_{GS} = 4.5V, I_D = 20A$ ④
$V_{GS(th)}$	Gate Threshold Voltage	1.0	—	2.5	V	$V_{DS} = V_{GS}, I_D = 250\mu A$
$g_{fs}$	Forward Transconductance	35	—	—	S	$V_{DS} = 25V, I_D = 23A$
$I_{DSS}$	Drain-to-Source Leakage Current	—	—	20	μA	$V_{DS} = 80V, V_{GS} = 0V$
		—	—	250		$V_{DS} = 80V, V_{GS} = 0V, T_J = 125^\circ\text{C}$
$I_{GSS}$	Gate-to-Source Forward Leakage	—	—	200	nA	$V_{GS} = 16V$
	Gate-to-Source Reverse Leakage	—	—	-200		$V_{GS} = -16V$
$Q_g$	Total Gate Charge	—	22	33	nC	$I_D = 23A$
$Q_{gs}$	Gate-to-Source Charge	—	6.0	9.1		$V_{DS} = 64V$
$Q_{gd}$	Gate-to-Drain ("Miller") Charge	—	11	17		$V_{GS} = 4.5V$
$t_{d(on)}$	Turn-On Delay Time	—	12	—		$V_{DD} = 40V$
$t_r$	Rise Time	—	95	—	ns	$I_D = 23A$
$t_{d(off)}$	Turn-Off Delay Time	—	36	—		$R_G = 8.3\Omega$
$t_f$	Fall Time	—	55	—		$V_{GS} = 4.5V$ ④
$L_D$	Internal Drain Inductance	—	4.5	—	nH	Between lead, 6mm (0.25in.) from package and center of die contact
$L_S$	Internal Source Inductance	—	7.5	—		
$C_{iss}$	Input Capacitance	—	1890	—	pF	$V_{GS} = 0V$
$C_{oss}$	Output Capacitance	—	260	—		$V_{DS} = 25V$
$C_{riss}$	Reverse Transfer Capacitance	—	35	—		$f = 1.0\text{MHz}$ , See Fig. 5
$C_{oss}$	Output Capacitance	—	1920	—		$V_{GS} = 0V, V_{DS} = 1.0V, f = 1.0\text{MHz}$
$C_{oss}$	Output Capacitance	—	170	—		$V_{GS} = 0V, V_{DS} = 64V, f = 1.0\text{MHz}$
$C_{oss\ eff.}$	Effective Output Capacitance	—	310	—		$V_{GS} = 0V, V_{DS} = 0V \text{ to } 64V$

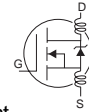

## Diode Characteristics

	Parameter	Min.	Typ.	Max.	Units	Conditions
$I_S$	Continuous Source Current (Body Diode)	—	—	39	A	MOSFET symbol showing the integral reverse p-n junction diode.
$I_{SM}$	Pulsed Source Current (Body Diode) ①	—	—	150		
$V_{SD}$	Diode Forward Voltage	—	—	1.3	V	$T_J = 25^\circ\text{C}, I_S = 23A, V_{GS} = 0V$ ④
$t_{rr}$	Reverse Recovery Time	—	75	110	ns	$T_J = 25^\circ\text{C}, I_F = 23A, V_{DD} = 25V$
$Q_{rr}$	Reverse Recovery Charge	—	210	310	nC	$di/dt = 100A/\mu s$ ④
$t_{on}$	Forward Turn-On Time	Intrinsic turn-on time is negligible (turn-on is dominated by $L_S+L_D$ )				

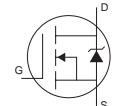

Notes ① through ⑧ are on page 11

HEXFET® is a registered trademark of International Rectifier.

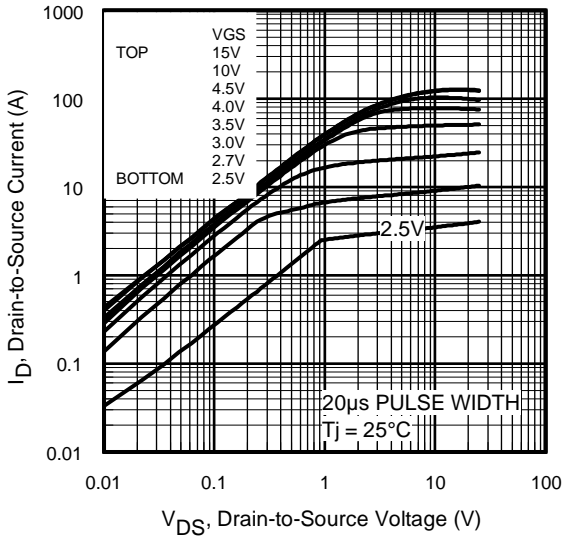

**Fig 1.** Typical Output Characteristics

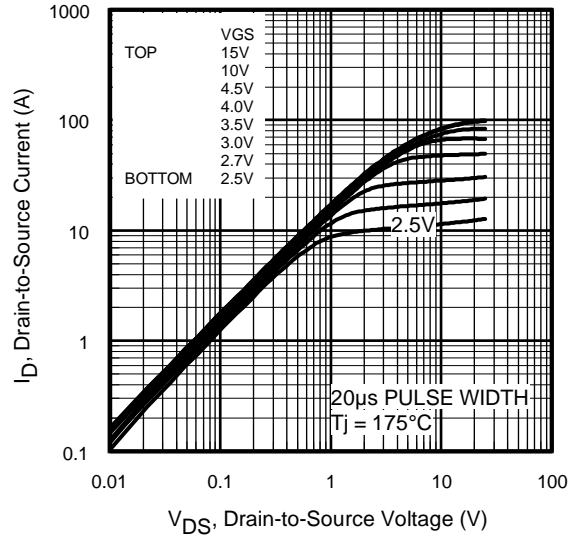

**Fig 2.** Typical Output Characteristics

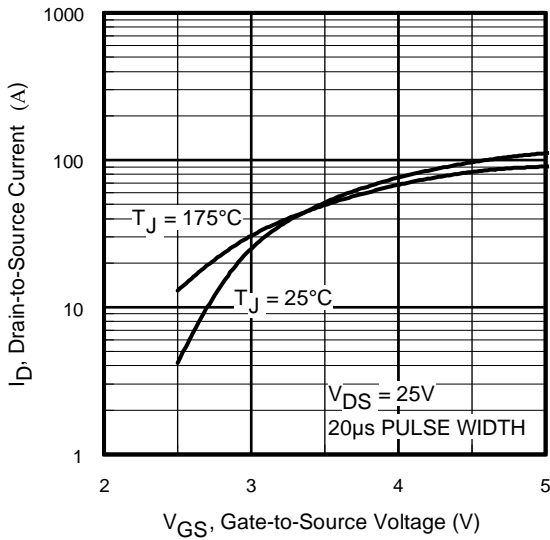

**Fig 3.** Typical Transfer Characteristics

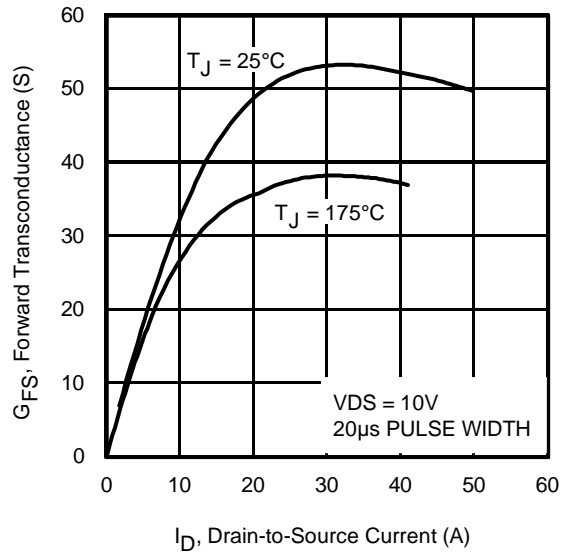

**Fig 4.** Typical Forward Transconductance vs. Drain Current

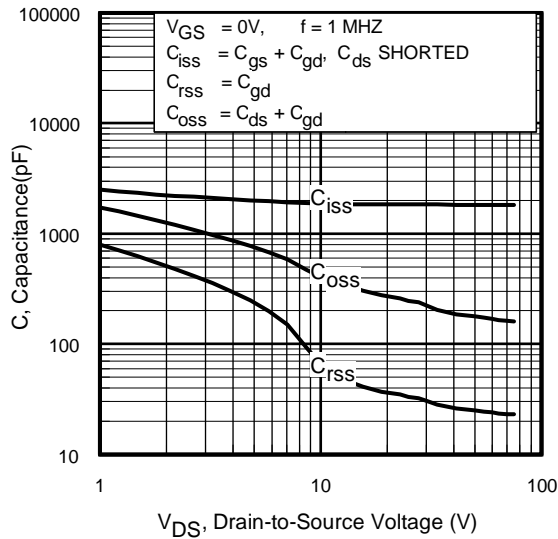

**Fig 5.** Typical Capacitance vs. Drain-to-Source Voltage

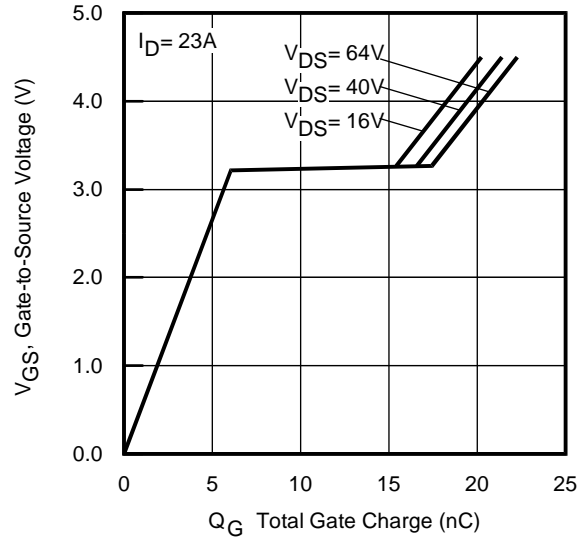

**Fig 6.** Typical Gate Charge vs. Gate-to-Source Voltage

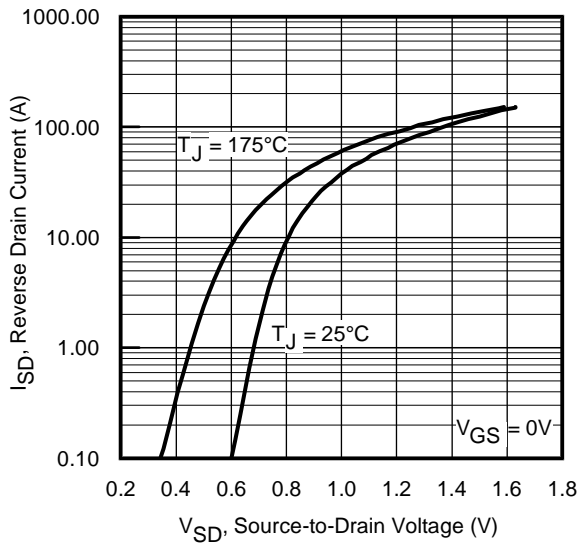

**Fig 7.** Typical Source-Drain Diode Forward Voltage

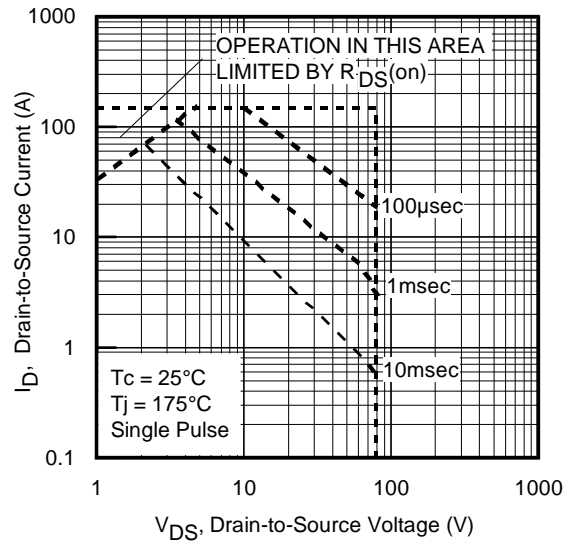

**Fig 8.** Maximum Safe Operating Area

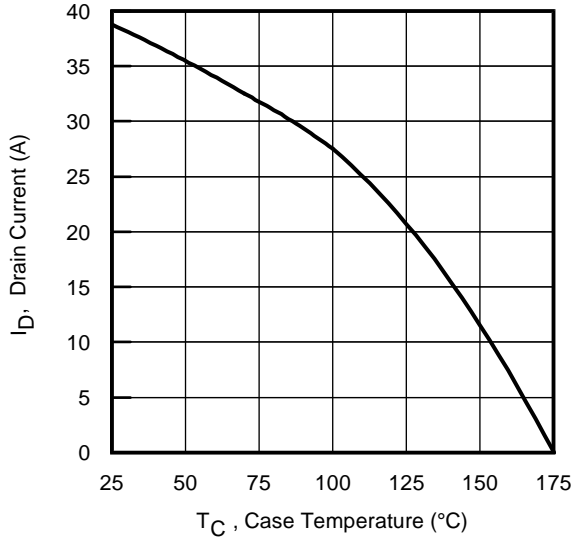

**Fig 9.** Maximum Drain Current vs. Case Temperature

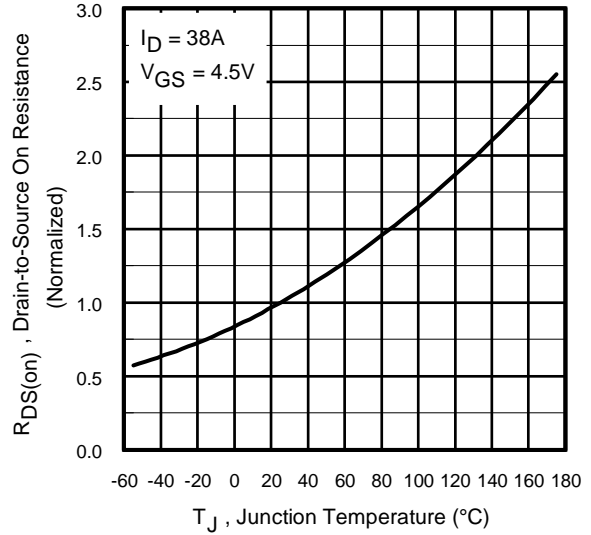

**Fig 10.** Normalized On-Resistance vs. Temperature

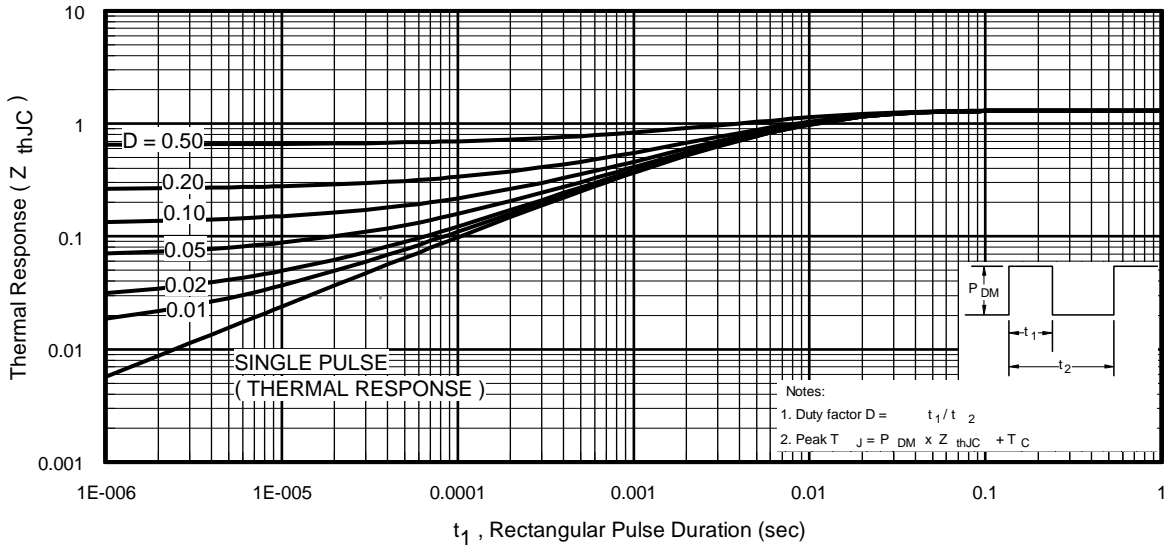

**Fig 11.** Maximum Effective Transient Thermal Impedance, Junction-to-Case

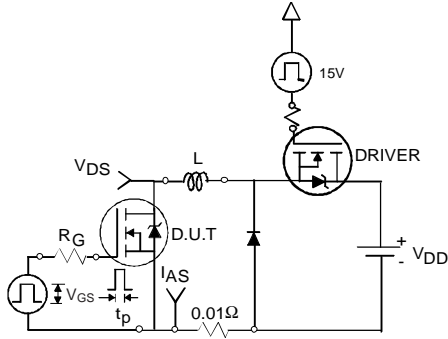

**Fig 12a.** Unclamped Inductive Test Circuit

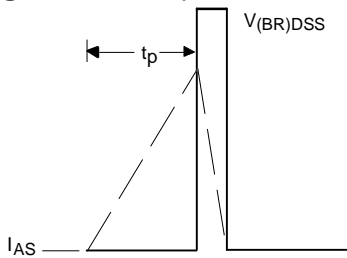

**Fig 12b.** Unclamped Inductive Waveforms

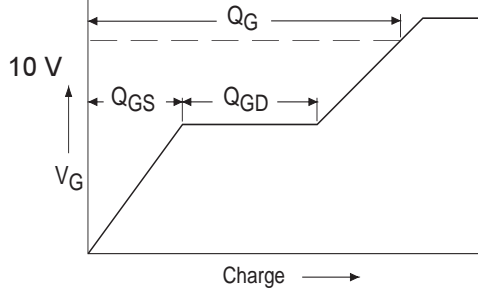

**Fig 13a.** Basic Gate Charge Waveform

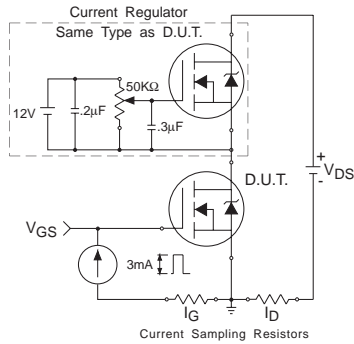

**Fig 13b.** Gate Charge Test Circuit

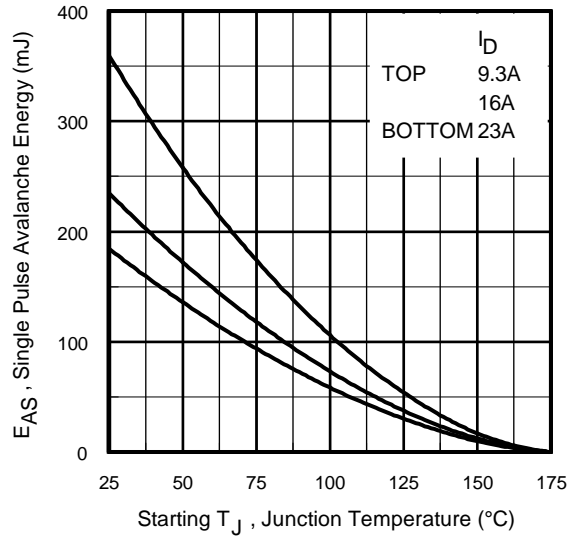

**Fig 12c.** Maximum Avalanche Energy vs. Drain Current

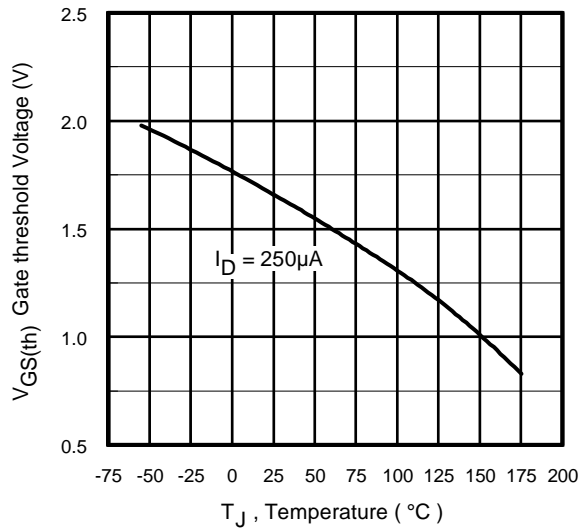

**Fig 14.** Threshold Voltage vs. Temperature

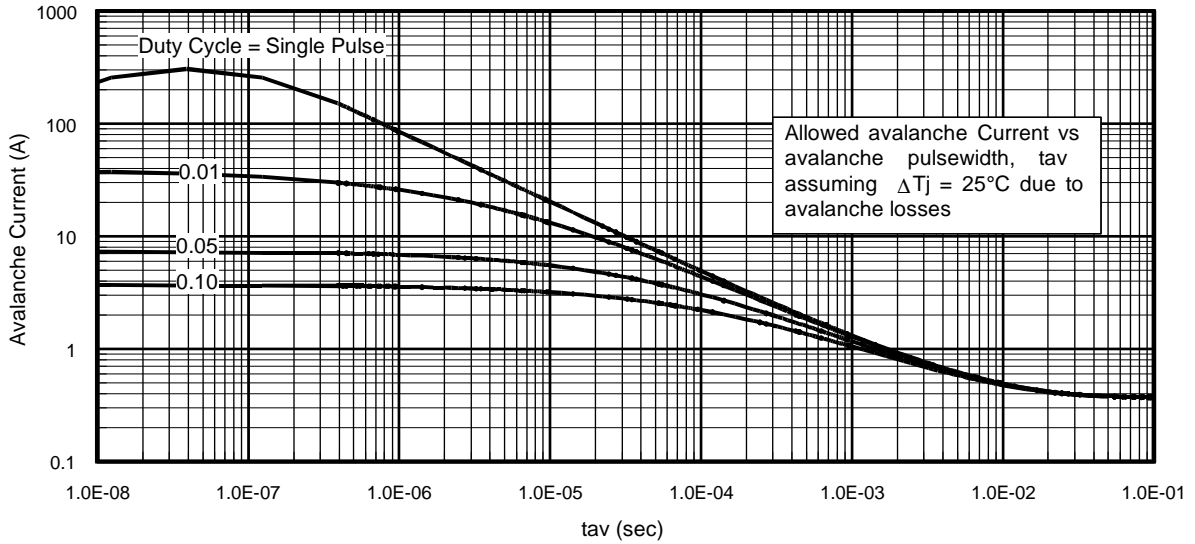

Fig 15. Typical Avalanche Current vs.Pulsewidth

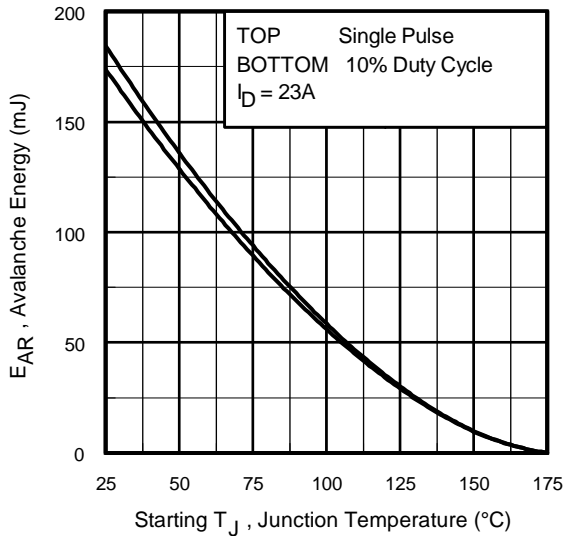

Fig 16. Maximum Avalanche Energy vs. Temperature

**Notes on Repetitive Avalanche Curves , Figures 15, 16:  
(For further info, see AN-1005 at www.irf.com)**

1. Avalanche failures assumption:  
Purely a thermal phenomenon and failure occurs at a temperature far in excess of  $T_{jmax}$ . This is validated for every part type.
2. Safe operation in Avalanche is allowed as long as  $T_{jmax}$  is not exceeded.
3. Equation below based on circuit and waveforms shown in Figures 12a, 12b.
4.  $P_{D(ave)}$  = Average power dissipation per single avalanche pulse.
5. BV = Rated breakdown voltage (1.3 factor accounts for voltage increase during avalanche).
6.  $I_{av}$  = Allowable avalanche current.
7.  $\Delta T$  = Allowable rise in junction temperature, not to exceed  $T_{jmax}$  (assumed as 25°C in Figure 15, 16).  
 $t_{av}$  = Average time in avalanche.  
 $D$  = Duty cycle in avalanche =  $t_{av} \cdot f$   
 $Z_{thJC}(D, t_{av})$  = Transient thermal resistance, see figure 11)

$$P_{D(ave)} = 1/2 ( 1.3 \cdot BV \cdot I_{av} ) = \Delta T / Z_{thJC}$$

$$I_{av} = 2\Delta T / [1.3 \cdot BV \cdot Z_{th}]$$

$$E_{AS(AR)} = P_{D(ave)} \cdot t_{av}$$

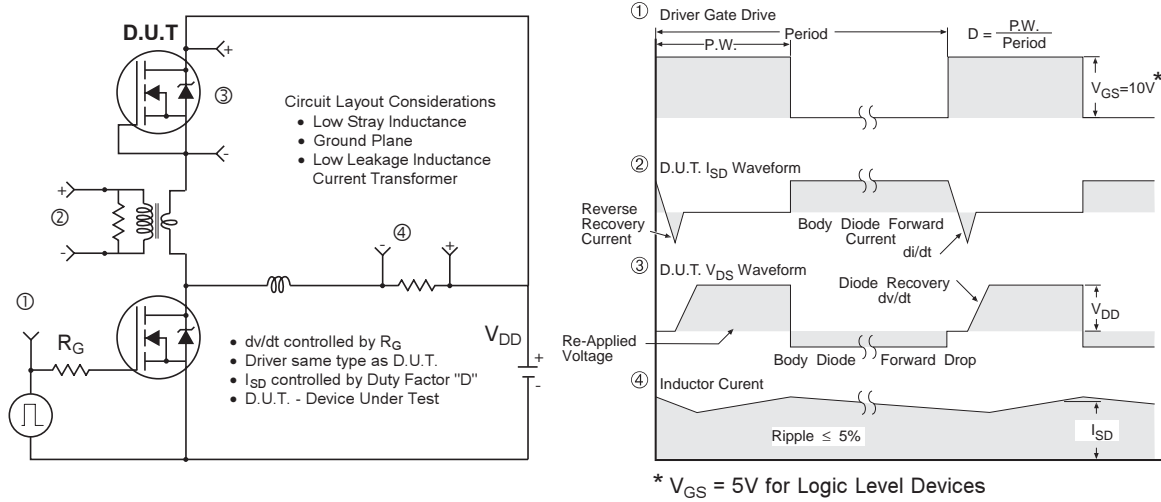

**Fig 17. Peak Diode Recovery  $dv/dt$  Test Circuit for N-Channel HEXFET® Power MOSFETs**

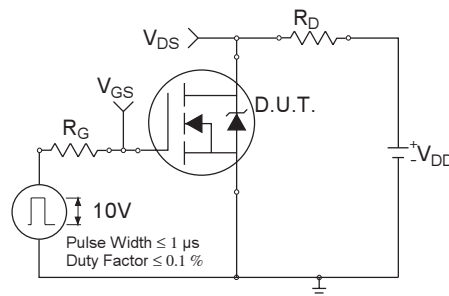

**Fig 18a. Switching Time Test Circuit**

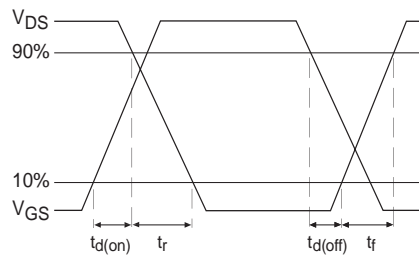
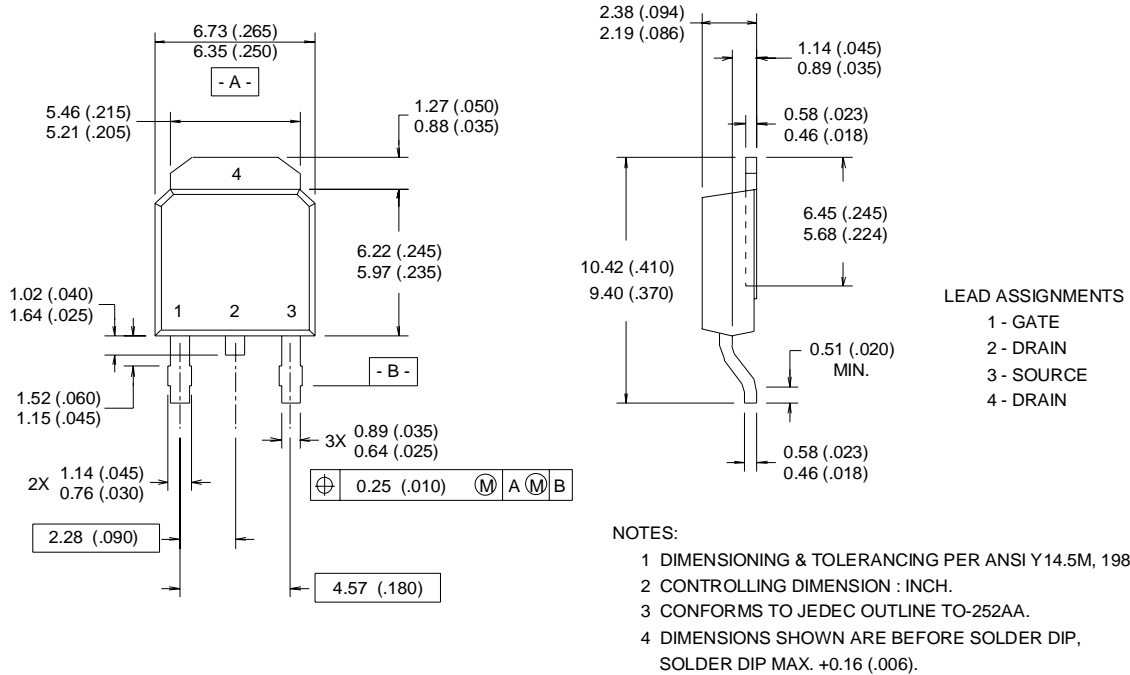

**Fig 18b. Switching Time Waveforms**



## TO-252AA (D-Pak) Package Outline

Dimensions are shown in millimeters (inches)



## TO-252AA (D-Pak) Part Marking Information

Notes: This part marking information applies to devices produced before 02/26/2001

EXAMPLE: THIS IS AN IRFR120  
WITH ASSEMBLY  
LOT CODE 9U1P

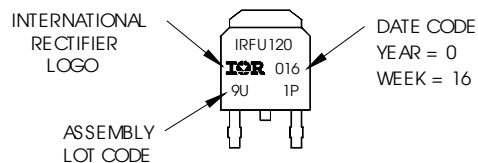

Notes: This part marking information applies to devices produced after 02/26/2001

EXAMPLE: THIS IS AN IRFR120  
WITH ASSEMBLY  
LOT CODE 1234  
ASSEMBLED ON WW 16, 1999  
IN THE ASSEMBLY LINE "A"

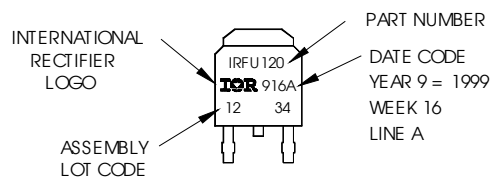

# IRLR2908/IRLU2908

## I-Pak (TO-251AA) Package Outline

Dimensions are shown in millimeters (inches)

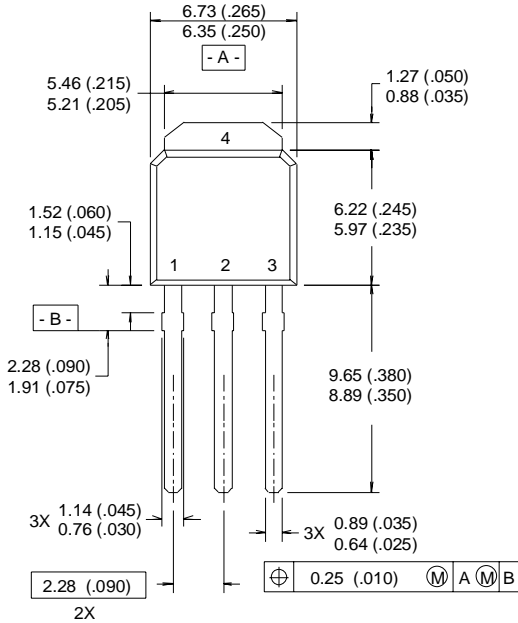

## I-Pak (TO-251AA) Part Marking Information

Notes: This part marking information applies to devices produced before 02/26/2001

EXAMPLE: THIS IS AN IRFR120  
WITH ASSEMBLY  
LOT CODE 9U1P

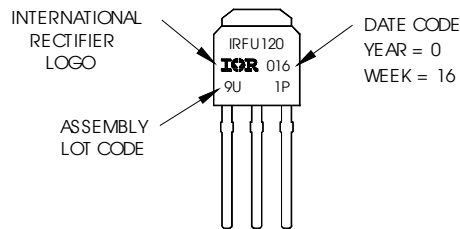

Notes: This part marking information applies to devices produced after 02/26/2001

EXAMPLE: THIS IS AN IRFR120  
WITH ASSEMBLY  
LOT CODE 5678  
ASSEMBLED ON WW 19, 1999  
IN THE ASSEMBLY LINE "A"

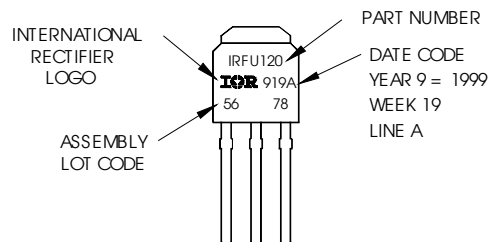

## D-Pak (TO-252AA) Tape & Reel Information

Dimensions are shown in millimeters (inches)

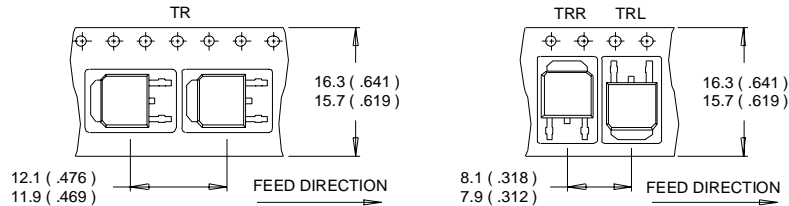

- NOTES :
1. CONTROLLING DIMENSION : MILLIMETER.
  2. ALL DIMENSIONS ARE SHOWN IN MILLIMETERS ( INCHES ).
  3. OUTLINE CONFORMS TO EIA-481 & EIA-541.

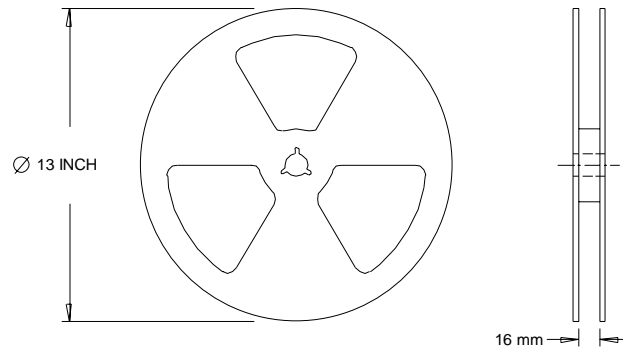

- NOTES :
1. OUTLINE CONFORMS TO EIA-481.

**Notes:**

- ① Repetitive rating; pulse width limited by max. junction temperature. (See fig. 11).
- ② Limited by  $T_{Jmax}$ , starting  $T_J = 25^\circ C$ ,  $L = 0.71mH$ ,  $R_G = 25\Omega$ ,  $I_{AS} = 23A$ ,  $V_{GS} = 10V$ . Part not recommended for use above this value.
- ③  $I_{SD} \leq 23A$ ,  $di/dt \leq 400A/\mu s$ ,  $V_{DD} \leq V_{(BR)DSS}$ ,  $T_J \leq 175^\circ C$ .
- ④ Pulse width  $\leq 1.0ms$ ; duty cycle  $\leq 2\%$ .
- ⑤  $C_{oss}$  eff. is a fixed capacitance that gives the same charging time as  $C_{oss}$  while  $V_{DS}$  is rising from 0 to 80%  $V_{DSS}$ .
- ⑥ Limited by  $T_{Jmax}$ , see Fig.12a, 12b, 15, 16 for typical repetitive avalanche performance.
- ⑦ This value determined from sample failure population. 100% tested to this value in production.
- ⑧ When mounted on 1" square PCB (FR-4 or G-10 Material). For recommended footprint and soldering techniques refer to application note #AN-994.

Data and specifications subject to change without notice.  
 This product has been designed and qualified for the Automotive [Q101] market.  
 Qualification Standards can be found on IR's Web site.

Note: For the most current drawings please refer to the IR website at:  
<http://www.irf.com/package/>