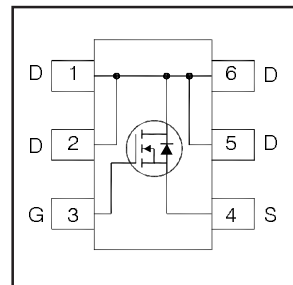


## IRFTS8342PbF

HEXFET® Power MOSFET

$V_{DS}$	<b>30</b>	<b>V</b>
$V_{GS}$	<b>±20</b>	<b>V</b>
$R_{DS(on) max}$ (@ $V_{GS} = 10V$ )	<b>19</b>	<b>mΩ</b>
$R_{DS(on) max}$ (@ $V_{GS} = 4.5V$ )	<b>29</b>	<b>mΩ</b>
$Q_g$ (typical)	<b>4.8</b>	<b>nC</b>
$I_D$ (@ $T_A = 25^\circ C$ )	<b>8.2</b>	<b>A</b>



### Applications

- System/Load Switch

### Features and Benefits

#### Features

Industry-Standard TSOP-6 Package
RoHS Compliant Containing no Lead, no Bromide and no Halogen
MSL1, Consumer Qualification

#### Resulting Benefits

Multi-Vendor Compatibility
Environmentally Friendlier
Increased Reliability



Orderable part number	Package Type	Standard Pack		Note
		Form	Quantity	
IRFTS8342TRPBF	TSOP-6	Tape and Reel	3000	

### Absolute Maximum Ratings

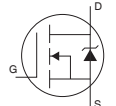
	Parameter	Max.	Units
$V_{DS}$	Drain-to-Source Voltage	30	V
$V_{GS}$	Gate-to-Source Voltage	±20	
$I_D @ T_A = 25^\circ C$	Continuous Drain Current, $V_{GS} @ 10V$	8.2	A
$I_D @ T_A = 70^\circ C$	Continuous Drain Current, $V_{GS} @ 10V$	6.6	
$I_{DM}$	Pulsed Drain Current ①	80	
$P_D @ T_A = 25^\circ C$	Power Dissipation ③	2.0	W
$P_D @ T_A = 70^\circ C$	Power Dissipation ③	1.3	
	Linear Derating Factor	0.02	W/°C
$T_J$	Operating Junction and	-55 to + 150	°C
$T_{STG}$	Storage Temperature Range		

Notes ① through ④ are on page 2

### Static @ $T_J = 25^\circ\text{C}$ (unless otherwise specified)

	Parameter	Min.	Typ.	Max.	Units	Conditions
$BV_{DSS}$	Drain-to-Source Breakdown Voltage	30	—	—	V	$V_{GS} = 0V, I_D = 250\mu A$
$\Delta BV_{DSS}/\Delta T_J$	Breakdown Voltage Temp. Coefficient	—	18	—	mV/°C	Reference to $25^\circ\text{C}, I_D = 1\text{mA}$
$R_{DS(on)}$	Static Drain-to-Source On-Resistance	—	15	19	mΩ	$V_{GS} = 10V, I_D = 8.2A$ ②
		—	22	29		$V_{GS} = 4.5V, I_D = 6.6A$ ②
$V_{GS(th)}$	Gate Threshold Voltage	1.35	1.80	2.35	V	$V_{DS} = V_{GS}, I_D = 25\mu A$
$\Delta V_{GS(th)}$	Gate Threshold Voltage Coefficient	—	-5.7	—	mV/°C	
$I_{DSS}$	Drain-to-Source Leakage Current	—	—	1.0	μA	$V_{DS} = 24V, V_{GS} = 0V$
		—	—	150		$V_{DS} = 24V, V_{GS} = 0V, T_J = 125^\circ\text{C}$
$I_{GSS}$	Gate-to-Source Forward Leakage	—	—	100	nA	$V_{GS} = 20V$
	Gate-to-Source Reverse Leakage	—	—	-100		$V_{GS} = -20V$
$g_{fs}$	Forward Transconductance	12	—	—	S	$V_{DS} = 10V, I_D = 6.6A$
$Q_g$	Total Gate Charge	—	4.8	—	nC	$V_{GS} = 4.5V$
$Q_{gs}$	Gate-to-Source Charge	—	2.1	—		$V_{DS} = 15V$
$Q_{gd}$	Gate-to-Drain Charge	—	1.6	—		$I_D = 6.6A$
$R_G$	Gate Resistance	—	2.6	—	Ω	
$t_{d(on)}$	Turn-On Delay Time	—	7.3	—	ns	$V_{DD} = 15V, V_{GS} = 4.5V$ ③ $I_D = 6.6A$ $R_G = 6.8\Omega$
$t_r$	Rise Time	—	15	—		
$t_{d(off)}$	Turn-Off Delay Time	—	9.1	—		
$t_f$	Fall Time	—	8.2	—		
$C_{iss}$	Input Capacitance	—	560	—	pF	$V_{GS} = 0V$
$C_{oss}$	Output Capacitance	—	102	—		$V_{DS} = 25V$
$C_{rss}$	Reverse Transfer Capacitance	—	48	—		$f = 1.0\text{MHz}$

### Diode Characteristics

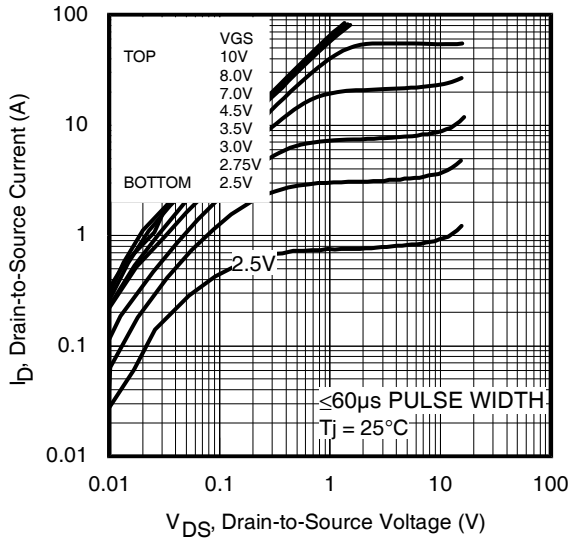
	Parameter	Min.	Typ.	Max.	Units	Conditions
$I_S$	Continuous Source Current (Body Diode)	—	—	2.5	A	MOSFET symbol showing the integral reverse p-n junction diode. 
$I_{SM}$	Pulsed Source Current (Body Diode) ①	—	—	80		
$V_{SD}$	Diode Forward Voltage	—	—	1.0	V	$T_J = 25^\circ\text{C}, I_S = 6.6A, V_{GS} = 0V$ ②
$t_{rr}$	Reverse Recovery Time	—	8.2	12	ns	$T_J = 25^\circ\text{C}, I_F = 6.6A, V_{DD} = 24V$
$Q_{rr}$	Reverse Recovery Charge	—	4.5	5.4	nC	$di/dt = 100/\mu s$ ②

### Thermal Resistance

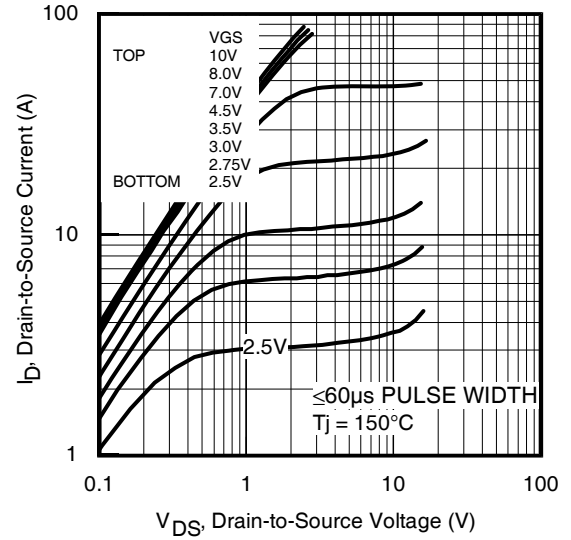
	Parameter	Typ.	Max.	Units
$R_{\theta JA}$	Junction-to-Ambient ③	—	62.5	°C/W

#### Notes:

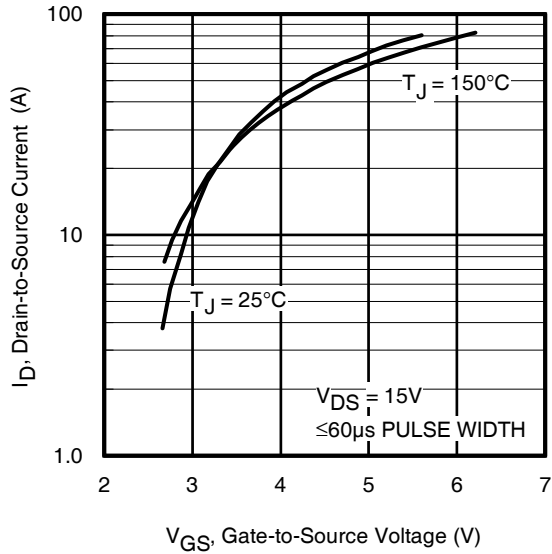
- ① Repetitive rating; pulse width limited by max. junction temperature.
- ② Pulse width  $\leq 400\mu s$ ; duty cycle  $\leq 2\%$ .
- ③ When mounted on 1 inch square copper board.



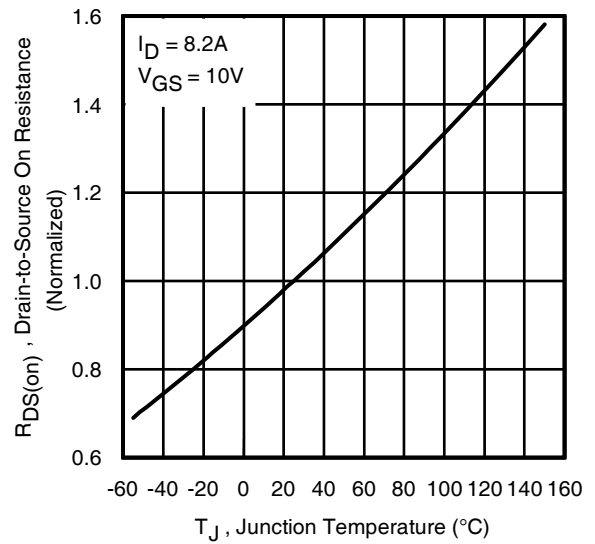
**Fig 1.** Typical Output Characteristics



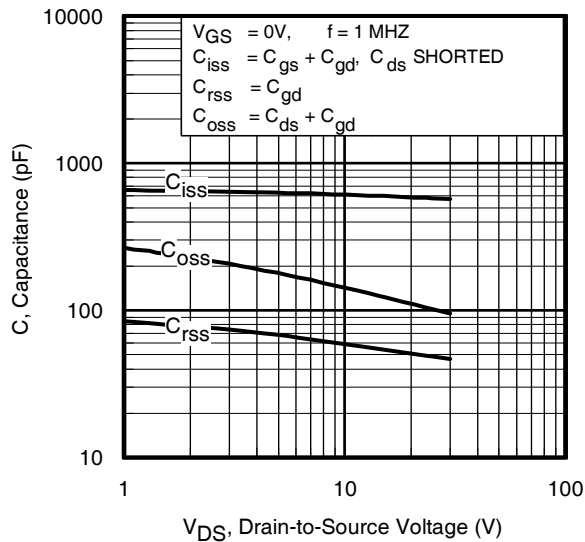
**Fig 2.** Typical Output Characteristics



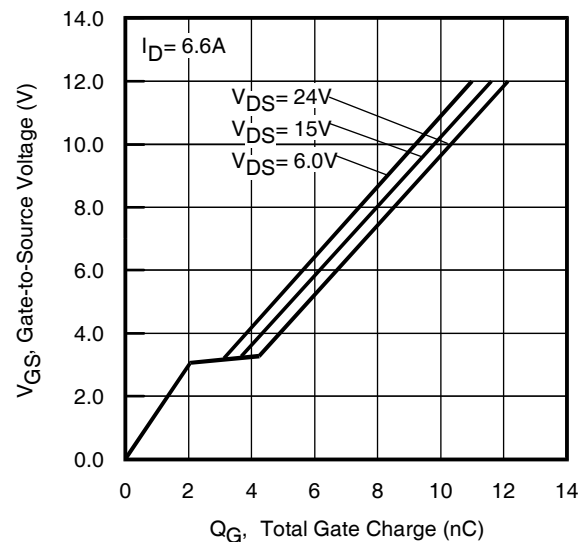
**Fig 3.** Typical Transfer Characteristics



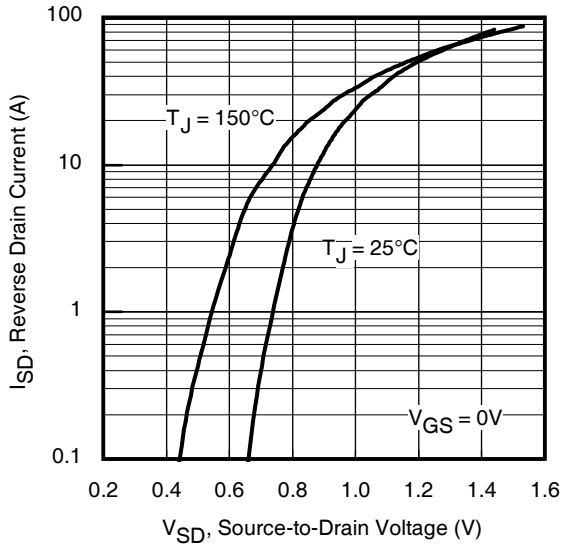
**Fig 4.** Normalized On-Resistance vs. Temperature



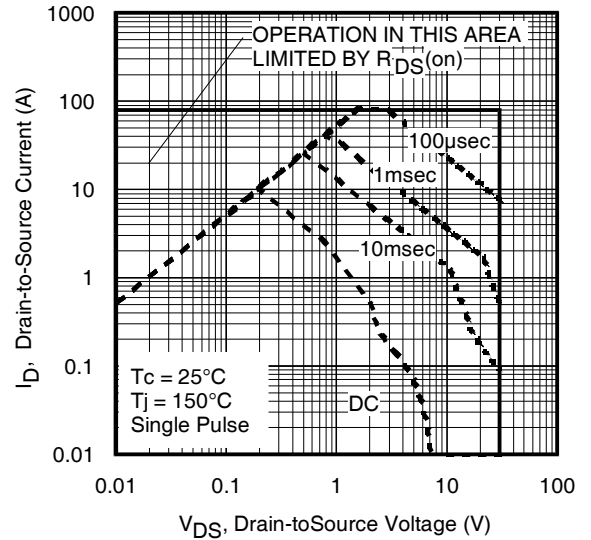
**Fig 5.** Typical Capacitance vs. Drain-to-Source Voltage  
www.irf.com



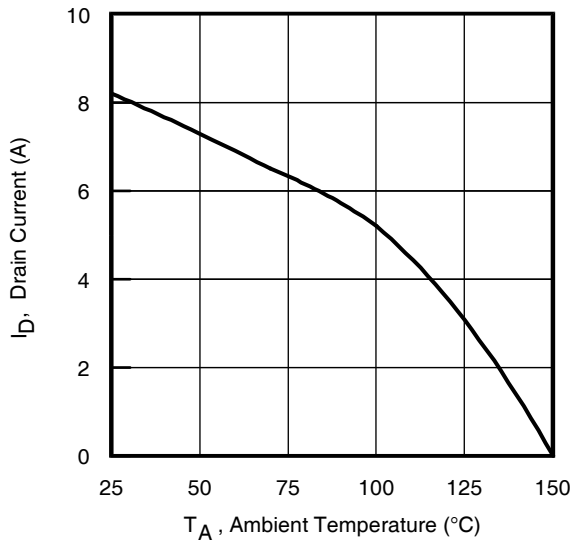
**Fig 6.** Typical Gate Charge vs. Gate-to-Source Voltage



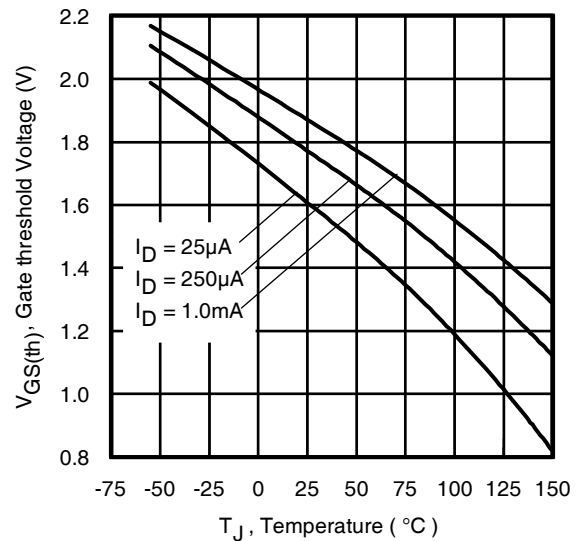
**Fig 7.** Typical Source-Drain Diode Forward Voltage



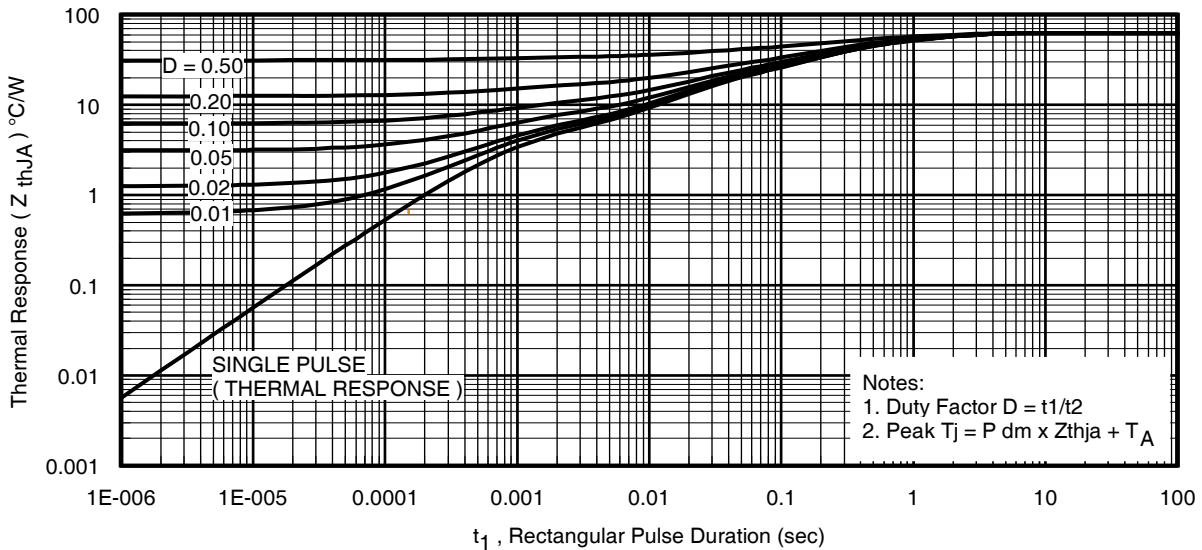
**Fig 8.** Maximum Safe Operating Area



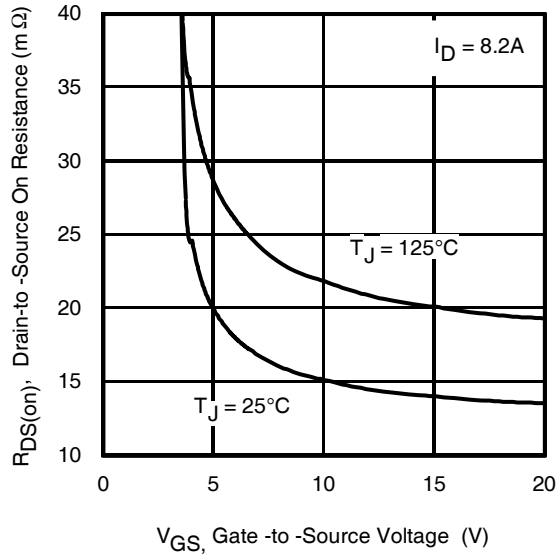
**Fig 9.** Maximum Drain Current vs. Ambient Temperature



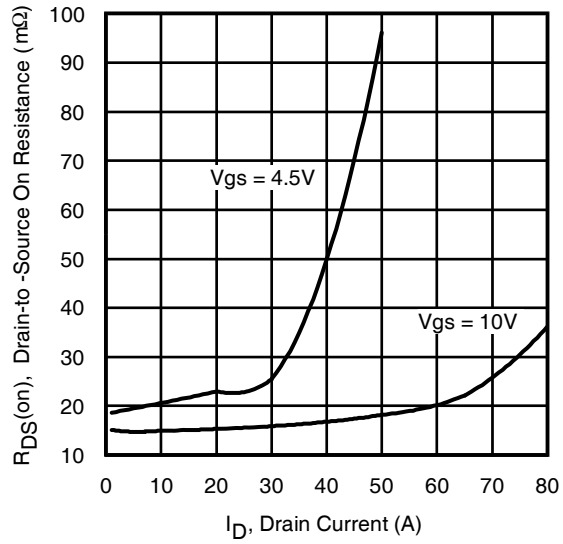
**Fig 10.** Threshold Voltage vs. Temperature



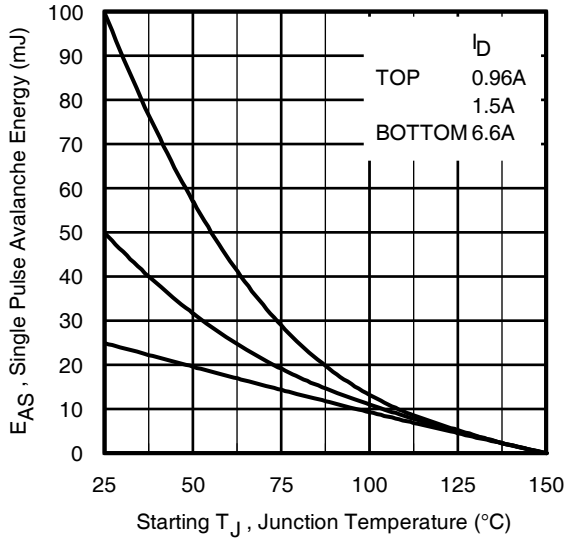
**Fig 11.** Maximum Effective Transient Thermal Impedance, Junction-to-Ambient



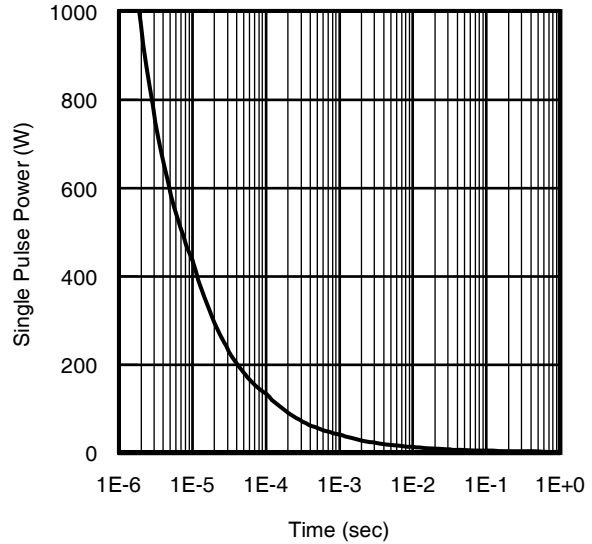
**Fig 12.** On-Resistance vs. Gate Voltage



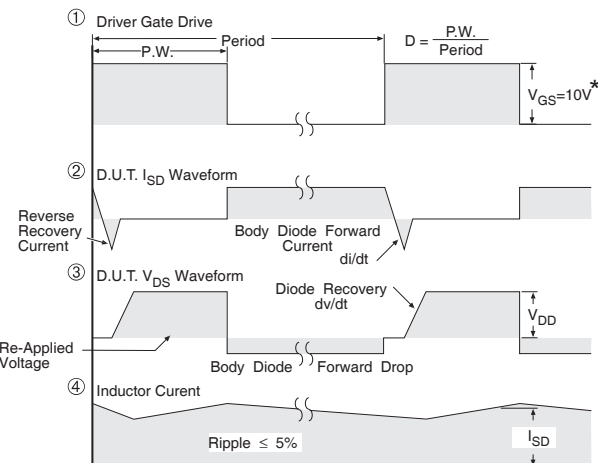
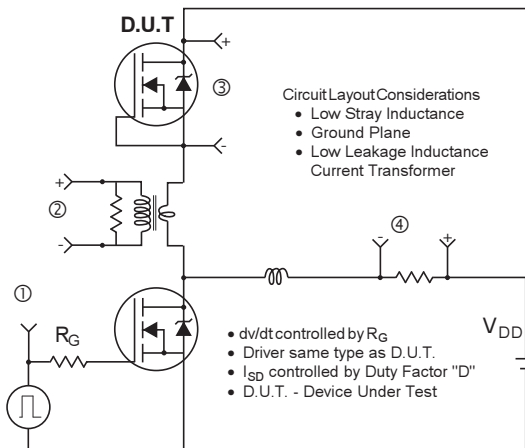
**Fig 13.** Typical On-Resistance vs. Drain Current



**Fig 14.** Maximum Avalanche Energy vs. Drain Current

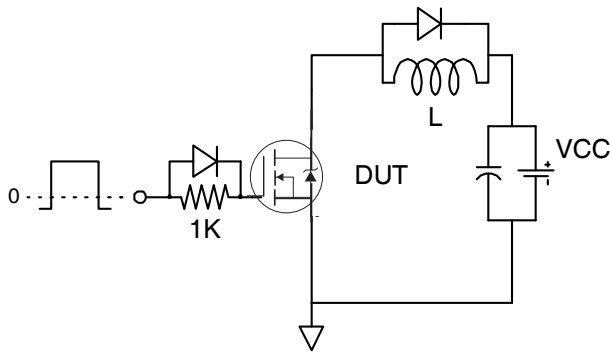


**Fig 15.** Typical Power vs. Time

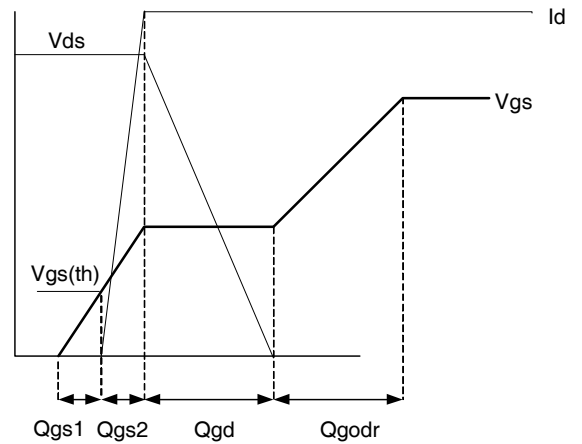


\*  $V_{GS} = 5V$  for Logic Level Devices

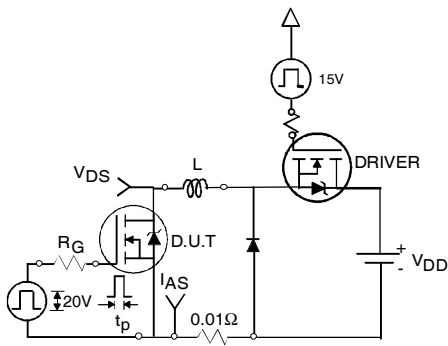
**Fig 16.** Peak Diode Recovery  $dv/dt$  Test Circuit for N-Channel HEXFET® Power MOSFETs



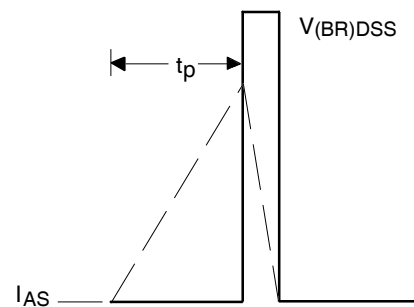
**Fig 17a.** Gate Charge Test Circuit



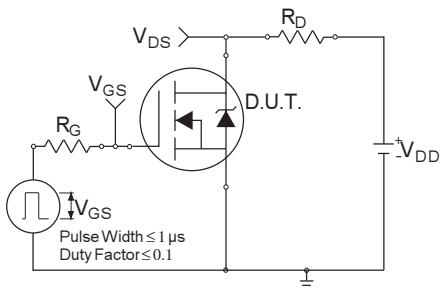
**Fig 17b.** Gate Charge Waveform



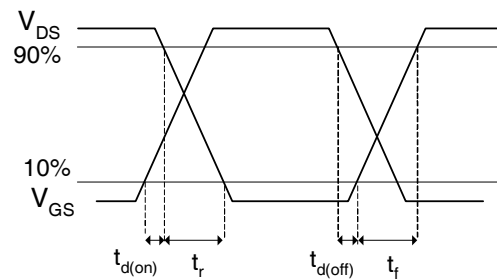
**Fig 18a.** Unclamped Inductive Test Circuit



**Fig 18b.** Unclamped Inductive Waveforms

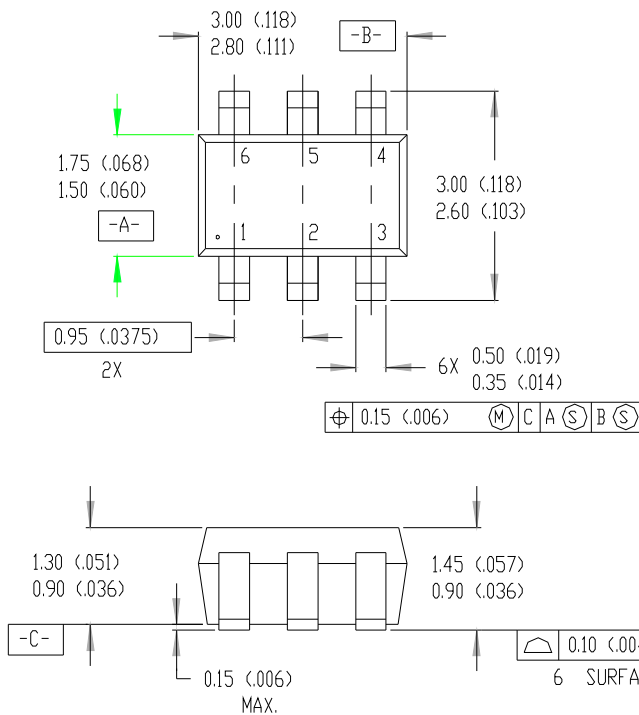


**Fig 19a.** Switching Time Test Circuit

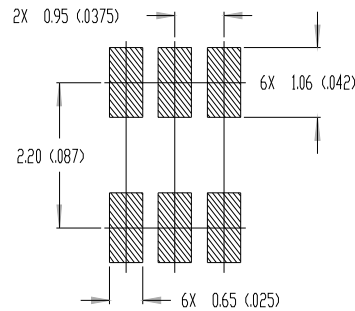


**Fig 19b.** Switching Time Waveforms

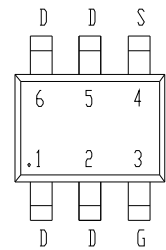
## TSOP-6 Package Outline



### MINIMUM RECOMMENDED FOOTPRINT

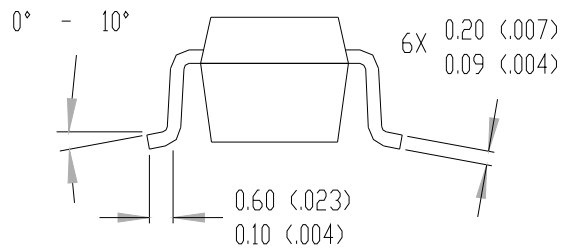


### LEAD ASSIGNMENTS

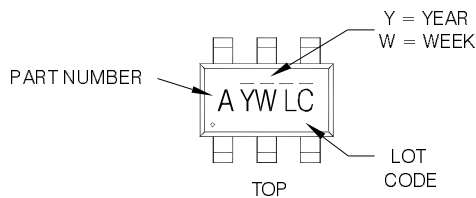


### NOTES:

1. DIMENSIONING & TOLERANCING PER ANSI Y14.5M-1982.
2. CONTROLLING DIMENSION: MILLIMETER.
3. DIMENSIONS ARE SHOWN IN MILLIMETERS (INCHES).



## TSOP-6 Part Marking Information



### PART NUMBER CODE REFERENCE:

A = SI3443DV	O = IRLTS6342TRPBF
B = IRF5800	P = IRF8342TRPBF
C = IRF5850	R = IRF8342TRPBF
D = IRF5851	S = Not applicable
E = IRF5852	T = IRLTS2242TRPBF
F = IRF5801	
G = IRF5803	
H = IRF5804	
I = IRF5805	
J = IRF5806	
K = IRF5810	
N = IRF5802	

Note: A line above the work week (as shown here) indicates Lead-Free.

### DATE CODE MARKING INSTRUCTIONS

WW = (1-26) IF PRECEDED BY LAST DIGIT OF CALENDAR YEAR

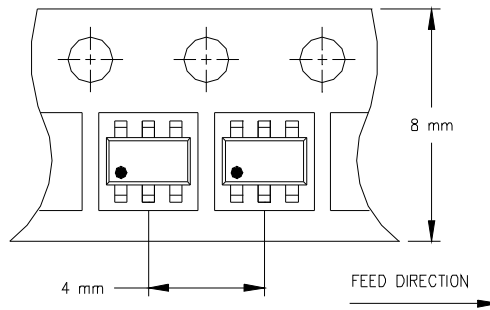
YEAR	Y	WORK WEEK	W
2011	2001	1	01 A
2012	2002	2	02 B
2013	2003	3	03 C
2014	2004	4	04 D
2015	2005	5	
2016	2006	6	
2017	2007	7	
2018	2008	8	
2019	2009	9	
2020	2010	0	24 X
			25 Y
			26 Z

WW = (27-52) IF PRECEDED BY A LETTER

YEAR	Y	WORK WEEK	W
2011	2001	A	27 A
2012	2002	B	28 B
2013	2003	C	29 C
2014	2004	D	30 D
2015	2005	E	
2016	2006	F	
2017	2007	G	
2018	2008	H	
2019	2009	J	
2020	2010	K	
			50 X
			51 Y
			52 Z

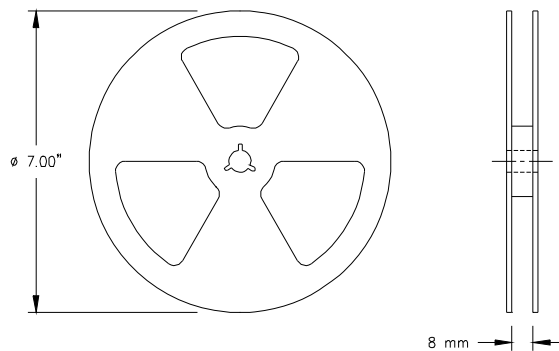
Note: For the most current drawing please refer to IR website at: <http://www.irf.com/package/>

## TSOP-6 Tape & Reel Information



**NOTES:**

1. OUTLINE CONFORMS TO EIA-481 & EIA-541.



**NOTES:**

1. OUTLINE CONFORMS TO EIA-481 & EIA-541.

### Qualification information<sup>†</sup>

Qualification level	Consumer <sup>††</sup> (per JEDEC JES D47F <sup>†††</sup> guidelines)	
Moisture Sensitivity Level	TSOP-6	MSL 1 (per JEDEC J-STD-020D <sup>†††</sup> )
RoHS compliant	Yes	

<sup>†</sup> Qualification standards can be found at International Rectifier's web site  
<http://www.irf.com/product-info/reliability>

<sup>††</sup> Higher qualification ratings may be available should the user have such requirements.  
Please contact your International Rectifier sales representative for further information:  
<http://www.irf.com/whoto-call/salesrep/>

<sup>†††</sup> Applicable version of JEDEC standard at the time of product release.

Data and specifications subject to change without notice.

International  
**IR** Rectifier

**IR WORLD HEADQUARTERS:** 101 N. Sepulveda Blvd., El Segundo, California 90245, USA Tel: (310) 252-7105  
TAC Fax: (310) 252-7903

Visit us at [www.irf.com](http://www.irf.com) for sales contact information. 02/2012