

## FEATURES

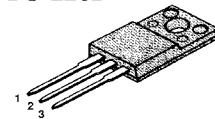
- Avalanche Rugged Technology
- Rugged Gate Oxide Technology
- Lower Input Capacitance
- Improved Gate Charge
- Extended Safe Operating Area
- Lower Leakage Current : 10  $\mu$ A (Max.) @  $V_{DS} = 250V$
- Lower  $R_{DS(ON)}$  : 0.327  $\Omega$  (Typ.)

$$BV_{DSS} = 250 \text{ V}$$

$$R_{DS(on)} = 0.45 \Omega$$

$$I_D = 5.8 \text{ A}$$

TO-220F



1. Gate 2. Drain 3. Source

## Absolute Maximum Ratings

Symbol	Characteristic	Value	Units
$V_{DSS}$	Drain-to-Source Voltage	250	V
$I_D$	Continuous Drain Current ( $T_C=25^\circ\text{C}$ )	5.8	A
	Continuous Drain Current ( $T_C=100^\circ\text{C}$ )	3.7	
$I_{DM}$	Drain Current-Pulsed ①	32	A
$V_{GS}$	Gate-to-Source Voltage	$\pm 30$	V
$E_{AS}$	Single Pulsed Avalanche Energy ②	210	mJ
$I_{AR}$	Avalanche Current ①	5.8	A
$E_{AR}$	Repetitive Avalanche Energy ①	3.8	mJ
dv/dt	Peak Diode Recovery dv/dt ③	4.8	V/ns
$P_D$	Total Power Dissipation ( $T_C=25^\circ\text{C}$ )	38	W
	Linear Derating Factor	0.3	
$T_J, T_{STG}$	Operating Junction and Storage Temperature Range	- 55 to +150	$^\circ\text{C}$
$T_L$	Maximum Lead Temp. for Soldering Purposes, 1/8" from case for 5-seconds	300	

## Thermal Resistance

Symbol	Characteristic	Typ.	Max.	Units
$R_{\theta JC}$	Junction-to-Case	--	3.29	$^\circ\text{C/W}$
$R_{\theta JA}$	Junction-to-Ambient	--	62.5	

### Electrical Characteristics ( $T_C=25^\circ\text{C}$ unless otherwise specified)

Symbol	Characteristic	Min.	Typ.	Max.	Units	Test Condition
$BV_{DSS}$	Drain-Source Breakdown Voltage	250	--	--	V	$V_{GS}=0V, I_D=250\mu A$
$\Delta BV/\Delta T_J$	Breakdown Voltage Temp. Coeff.	--	0.29	--	V/ $^\circ\text{C}$	$I_D=250\mu A$ <b>See Fig 7</b>
$V_{GS(th)}$	Gate Threshold Voltage	2.0	--	4.0	V	$V_{DS}=5V, I_D=250\mu A$
$I_{GSS}$	Gate-Source Leakage, Forward	--	--	100	nA	$V_{GS}=30V$
	Gate-Source Leakage, Reverse	--	--	-100	nA	$V_{GS}=-30V$
$I_{DSS}$	Drain-to-Source Leakage Current	--	--	10	$\mu A$	$V_{DS}=250V$
		--	--	100		$V_{DS}=200V, T_C=125^\circ\text{C}$
$R_{DS(on)}$	Static Drain-Source On-State Resistance	--	--	0.45	$\Omega$	$V_{GS}=10V, I_D=2.9A$ ④
$g_{fs}$	Forward Transconductance	--	5.41	--	$\text{S}$	$V_{DS}=40V, I_D=2.9A$ ④
$C_{iss}$	Input Capacitance	--	730	950	pF	$V_{GS}=0V, V_{DS}=25V, f=1\text{MHz}$ <b>See Fig 5</b>
$C_{oss}$	Output Capacitance	--	110	130		
$C_{riss}$	Reverse Transfer Capacitance	--	50	60		
$t_{d(on)}$	Turn-On Delay Time	--	13	40	ns	$V_{DD}=125V, I_D=8.1A,$ $R_G=12\Omega$ <b>See Fig 13</b> ④ ⑤
$t_r$	Rise Time	--	14	40		
$t_{d(off)}$	Turn-Off Delay Time	--	53	120		
$t_f$	Fall Time	--	21	50		
$Q_g$	Total Gate Charge	--	30	40	nC	$V_{DS}=200V, V_{GS}=10V,$ $I_D=8.1A$ <b>See Fig 6 &amp; Fig 12</b> ④ ⑤
$Q_{gs}$	Gate-Source Charge	--	5.8	--		
$Q_{gd}$	Gate-Drain("Miller") Charge	--	13.5	--		

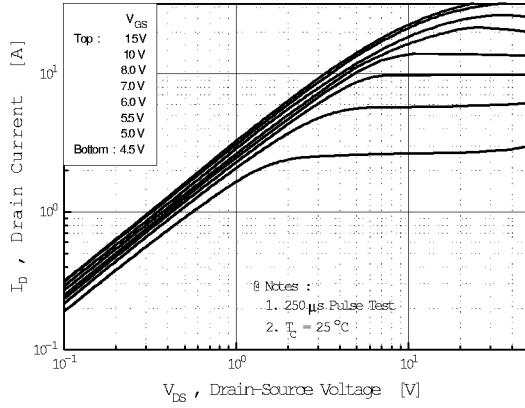
### Source-Drain Diode Ratings and Characteristics

Symbol	Characteristic	Min.	Typ.	Max.	Units	Test Condition
$I_S$	Continuous Source Current	--	--	5.8	A	Integral reverse pn-diode in the MOSFET
$I_{SM}$	Pulsed-Source Current ①	--	--	32		
$V_{SD}$	Diode Forward Voltage ④	--	--	1.5	V	$T_J=25^\circ\text{C}, I_S=5.8A, V_{GS}=0V$
$t_{rr}$	Reverse Recovery Time	--	190	--	ns	$T_J=25^\circ\text{C}, I_F=8.1A$
$Q_{rr}$	Reverse Recovery Charge	--	1.28	--	$\mu\text{C}$	$di_F/dt=100A/\mu\text{s}$ ④

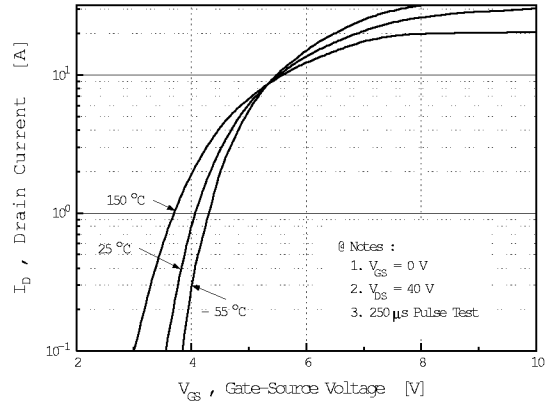
#### Notes ;

- ① Repetitive Rating : Pulse Width Limited by Maximum Junction Temperature
- ②  $L=10\text{mH}, I_{AS}=5.8A, V_{DD}=50V, R_G=27\Omega,$  Starting  $T_J=25^\circ\text{C}$
- ③  $I_{SD} \leq 8.1A, di/dt \leq 210A/\mu\text{s}, V_{DD} \leq BV_{DSS},$  Starting  $T_J=25^\circ\text{C}$
- ④ Pulse Test : Pulse Width = 250  $\mu\text{s}$ , Duty Cycle  $\leq 2\%$
- ⑤ Essentially Independent of Operating Temperature

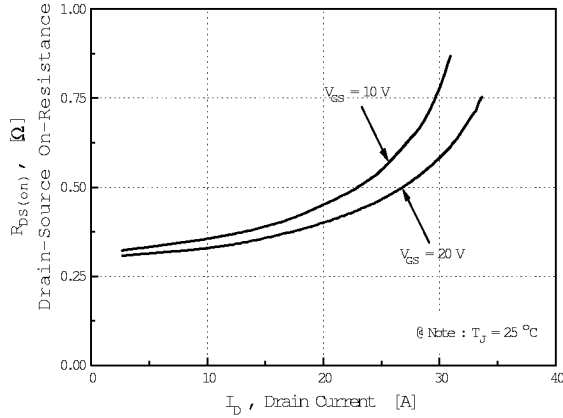
**Fig 1. Output Characteristics**



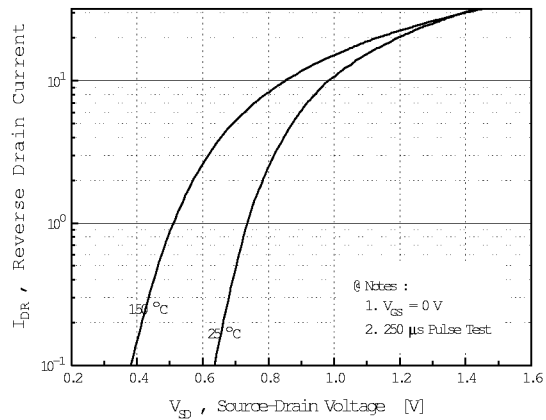
**Fig 2. Transfer Characteristics**



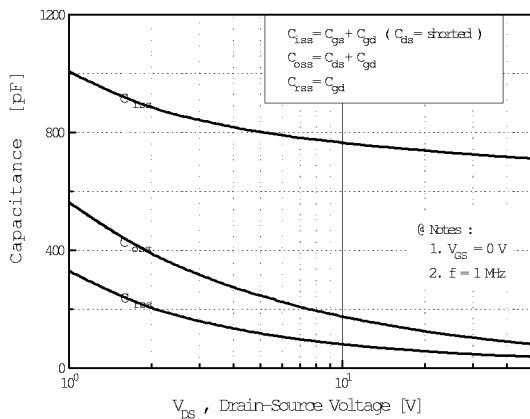
**Fig 3. On-Resistance vs. Drain Current**



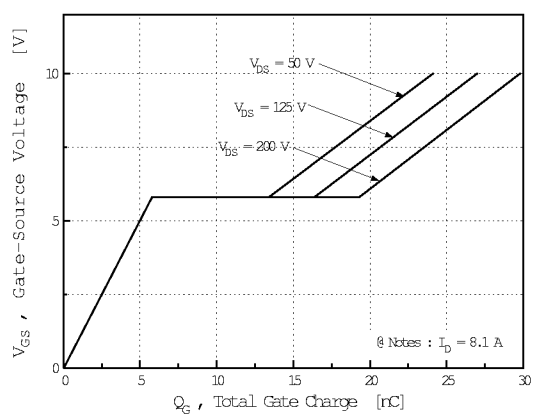
**Fig 4. Source-Drain Diode Forward Voltage**

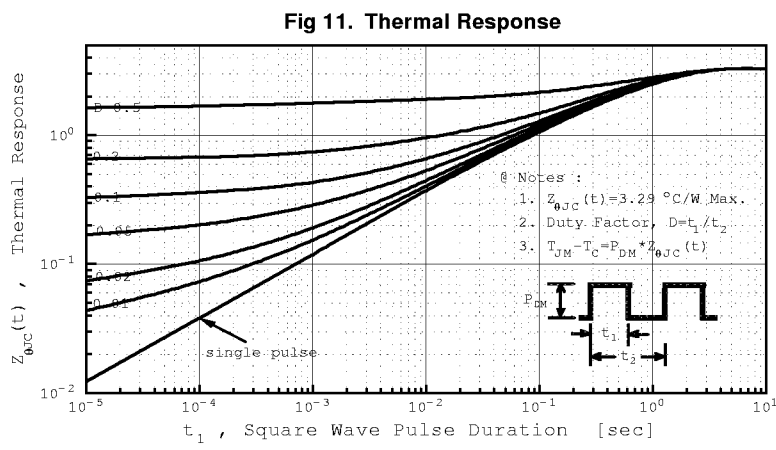
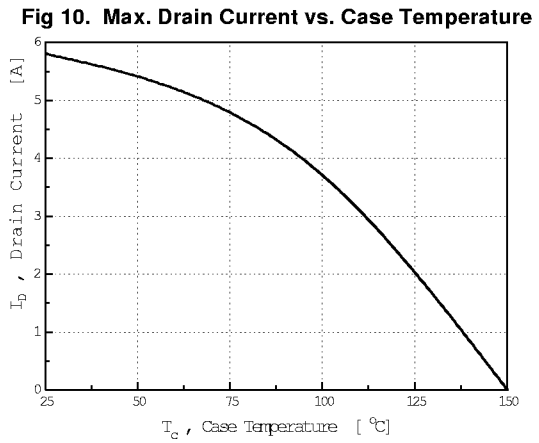
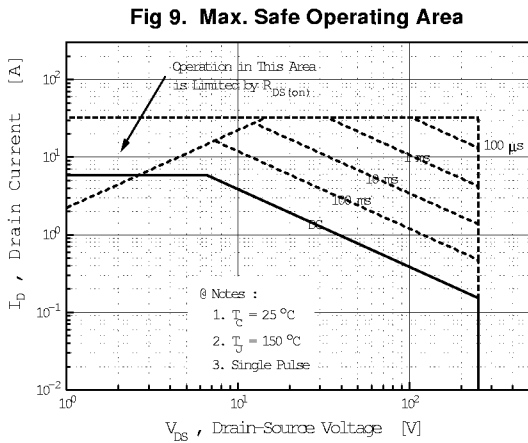
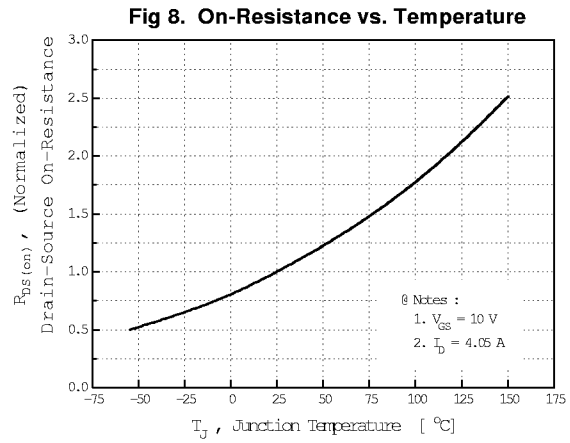
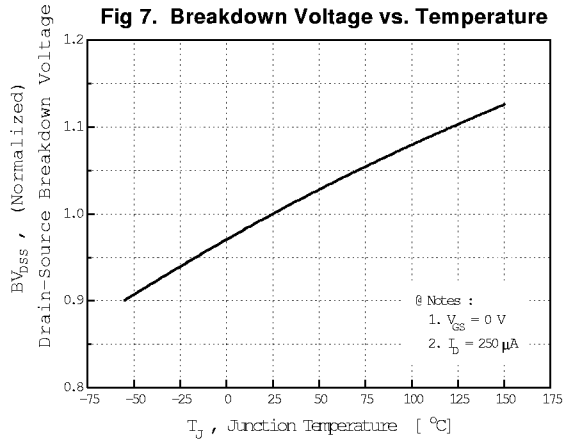


**Fig 5. Capacitance vs. Drain-Source Voltage**

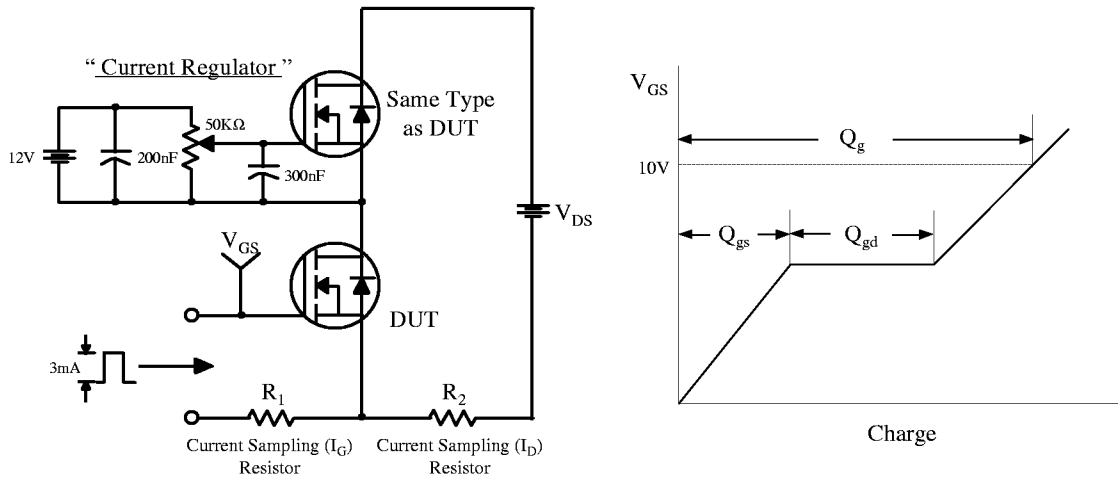


**Fig 6. Gate Charge vs. Gate-Source Voltage**

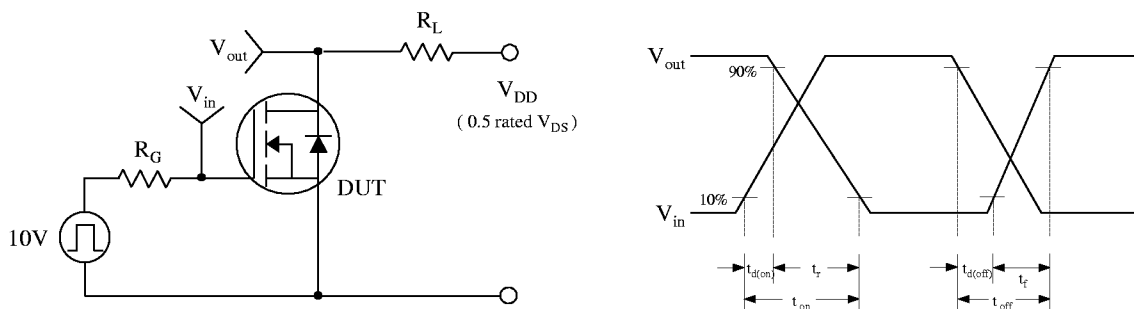




**Fig 12. Gate Charge Test Circuit & Waveform**



**Fig 13. Resistive Switching Test Circuit & Waveforms**



**Fig 14. Unclamped Inductive Switching Test Circuit & Waveforms**

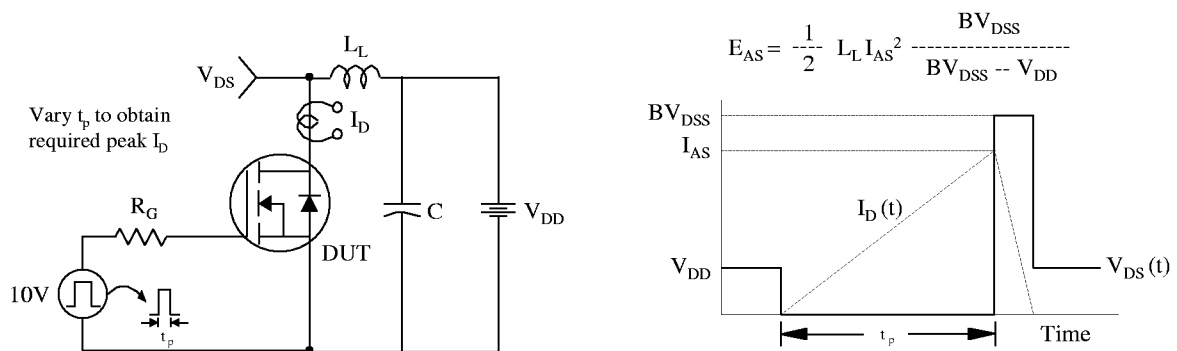


Fig 15. Peak Diode Recovery dv/dt Test Circuit & Waveforms

