

### 1.5A, 500V, 7.000 Ohm, N-Channel Power MOSFETs

These are N-Channel enhancement mode silicon gate power field effect transistors. They are advanced power MOSFETs designed, tested, and guaranteed to withstand a specified level of energy in the breakdown avalanche mode of operation. All of these power MOSFETs are designed for applications such as switching regulators, switching convertors, motor drivers, relay drivers, and drivers for high power bipolar switching transistors requiring high speed and low gate drive power. These types can be operated directly from integrated circuits.

Formerly developmental type TA17445.

### Ordering Information

PART NUMBER	PACKAGE	BRAND
IRFU410	TO-251AA	IFU410
IRFR410	TO-252AA	IFR410

NOTE: When ordering, use the entire part number.

### Features

- 1.5A, 500V
- $r_{DS(ON)} = 7.000\Omega$
- Single Pulse Avalanche Energy Rated
- SOA is Power Dissipation Limited
- Nanosecond Switching Speeds
- High Input Impedance
- 150°C Operating Temperature
- Related Literature
  - TB334 "Guidelines for Soldering Surface Mount Components to PC Boards"

### Symbol

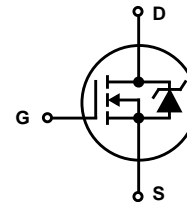

### Packaging

JEDEC TO-251AA

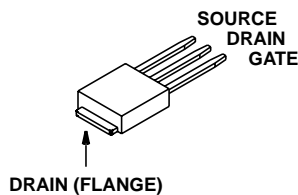

JEDEC TO-252AA

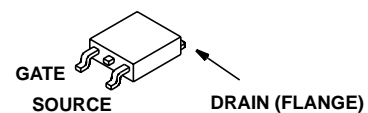

## IRFR410, IRFU410

### Absolute Maximum Ratings $T_C = 25^\circ\text{C}$ , Unless Otherwise Specified

	IRFR410, IRFU410	UNITS
Drain to Source Voltage (Note 1) . . . . .	500	V
Drain to Gate Voltage ( $R_{GS} = 20\text{k}\Omega$ ) (Note 1) . . . . .	500	V
Continuous Drain Current . . . . .	1.5	A
$T_C = 100^\circ\text{C}$ . . . . .	1.2	A
Pulsed Drain Current (Note 3) . . . . .	3.0	A
Gate to Source Voltage . . . . .	$\pm 20$	V
Maximum Power Dissipation . . . . .	42	W
Linear Derating Factor . . . . .	0.33	$\text{W}/^\circ\text{C}$
Single Pulse Avalanche Rating (See Figure 5) (Note 4) . . . . .	Refer to UIS Curve	mJ
Operating and Storage Temperature . . . . .	-55 to 150	$^\circ\text{C}$
Maximum Temperature for Soldering		
Leads at 0.063in (1.6mm) from Case for 10s . . . . .	300	$^\circ\text{C}$
Package Body for 10s, See Techbrief 334 . . . . .	260	$^\circ\text{C}$

*CAUTION: Stresses above those listed in "Absolute Maximum Ratings" may cause permanent damage to the device. This is a stress only rating and operation of the device at these or any other conditions above those indicated in the operational sections of this specification is not implied.*

**NOTE:**

1.  $T_J = 25^\circ\text{C}$  to  $125^\circ\text{C}$ .

### Electrical Specifications $T_C = 25^\circ\text{C}$ , Unless Otherwise Specified

PARAMETER	SYMBOL	TEST CONDITIONS	MIN	TYP	MAX	UNITS
Drain to Source Breakdown Voltage	$BV_{DSS}$	$I_D = 250\mu\text{A}$ , $V_{GS} = 0\text{V}$	500	-	-	V
Temperature Coefficient of Breakdown Voltage	$\Delta B-V_{DSS}/\Delta T_J$	Reference to $25^\circ\text{C}$ , $I_D = 250\mu\text{A}$	-	0.61	-	$\text{V}/^\circ\text{C}$
Gate to Source Threshold Voltage	$V_{GS(TH)}$	$V_{GS} = V_{DS}$ , $I_D = 250\mu\text{A}$	2	-	4	V
Zero Gate Voltage Drain Current	$I_{DSS}$	$V_{DS} = 500\text{V}$ , $V_{GS} = 0\text{V}$	-	-	25	$\mu\text{A}$
		$V_{DS} = 500\text{V}$ , $V_{GS} = 0\text{V}$ , $T_J = 125^\circ\text{C}$	-	-	250	$\mu\text{A}$
Gate to Source Leakage Current	$I_{GSS}$	$V_{GS} = \pm 20\text{V}$	-	-	$\pm 100$	nA
Drain to Source On Resistance (Note 3)	$r_{DS(ON)}$	$I_D = 1.5\text{A}$ , $V_{GS} = 10\text{V}$ , (Figure 9)	-	-	7.000	$\Omega$
Forward Transconductance (Note 3)	$g_{fs}$	$V_{DS} = 50\text{V}$ , $I_{DS} = 0.75\text{A}$ , (Figure 8)	0.5	-	-	S
Turn-On Delay Time	$t_{d(ON)}$	$V_{DD} = 250\text{V}$ , $I_D \approx 1.5\text{A}$ , $R_{GS} = 24\Omega$ , $R_L = 167\Omega$ , MOSFET Switching Times are Essentially Independent of Operating Temperature	-	7	-	ns
Rise Time	$t_r$		-	10	-	ns
Turn-Off Delay Time	$t_{d(OFF)}$		-	24	-	ns
Fall Time	$t_f$		-	15	-	ns
Total Gate Charge	$Q_g(\text{TOT})$	$V_{GS} = 10\text{V}$ , $I_D \approx 1.5\text{A}$ , $V_{DS} = 0.8 \times \text{Rated } BV_{DSS}$ , (Figure 12) Gate Charge is Essentially Independent of Operating Temperature	-	9	12	nC
Gate to Source Charge	$Q_{gs}$		-	1.1	1.4	nC
Gate to Drain "Miller" Charge	$Q_{gd}$		-	5	7	nC
Input Capacitance	$C_{ISS}$	$V_{GS} = 0\text{V}$ , $V_{DS} = 25\text{V}$ , $f = 1.0\text{MHz}$ , (Figure 10)	-	210	-	pF
Output Capacitance	$C_{OSS}$		-	30	-	pF
Reverse Transfer Capacitance	$C_{RSS}$		-	7	-	pF

# IRFR410, IRFU410

## Electrical Specifications $T_C = 25^\circ\text{C}$ , Unless Otherwise Specified (Continued)

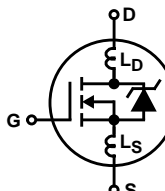
PARAMETER	SYMBOL	TEST CONDITIONS		MIN	TYP	MAX	UNITS
Internal Drain Inductance	$L_D$	Measured From the Drain Lead, 6mm (0.25in) From Package to Center of Die	Modified MOSFET Symbol Showing the Internal Devices Inductances	-	4.5	-	nH
Internal Source Inductance	$L_S$	Measured From The Source Lead, 6mm (0.25in) From Header to Source Bonding Pad			-	7.5	-
Thermal Resistance Junction to Case	$R_{\theta JC}$			-	-	3.0	$^\circ\text{C/W}$
Thermal Resistance Junction to Ambient	$R_{\theta JA}$	Free Air Operation		-	-	110	$^\circ\text{C/W}$

## Source to Drain Diode Specifications

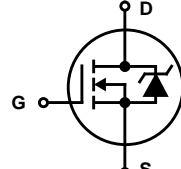
PARAMETER	SYMBOL	TEST CONDITIONS		MIN	TYP	MAX	UNITS
Continuous Source to Drain Current	$I_{SD}$	Modified MOSFET Symbol Showing the Integral Reverse P-N Junction Diode		-	-	1.5	A
Pulse Source to Drain Current (Note 3)	$I_{SDM}$			-	-	3.0	A
Source to Drain Diode Voltage (Note 2)	$V_{SD}$	$T_J = 25^\circ\text{C}$ , $I_{SD} = 1.5\text{A}$ , $V_{GS} = 0\text{V}$ , (Figure 11)		-	-	2.0	V
Reverse Recovery Time	$t_{rr}$	$T_J = 25^\circ\text{C}$ , $I_{SD} = 1.5\text{A}$ , $dI_{SD}/dt = 100\text{A}/\mu\text{s}$		130	-	520	ns

### NOTES:

- Pulse test: pulse width  $\leq 300\mu\text{s}$ , duty cycle  $\leq 2\%$ .
- Repetitive rating: pulse width limited by maximum junction temperature. See Transient Thermal Impedance curve. (Figure 3)
- $V_{DD} = 50\text{V}$ , starting  $T_J = 25^\circ\text{C}$ ,  $L = 40\mu\text{H}$ ,  $R_G = 25\Omega$ , peak  $I_{AS} = 1.5\text{A}$ .

## Typical Performance Curves Unless Otherwise Specified

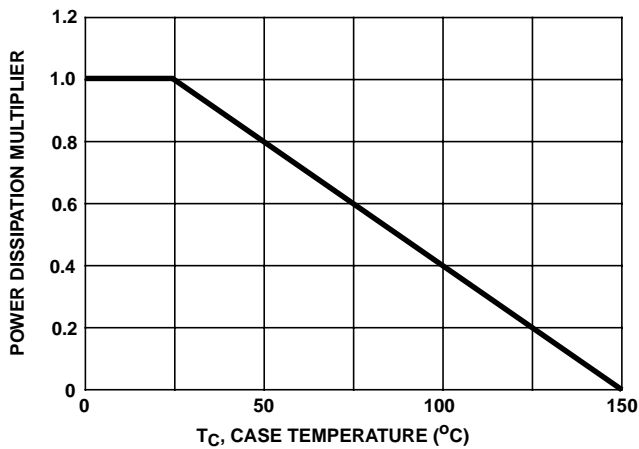

FIGURE 1. NORMALIZED POWER DISSIPATION vs CASE TEMPERATURE

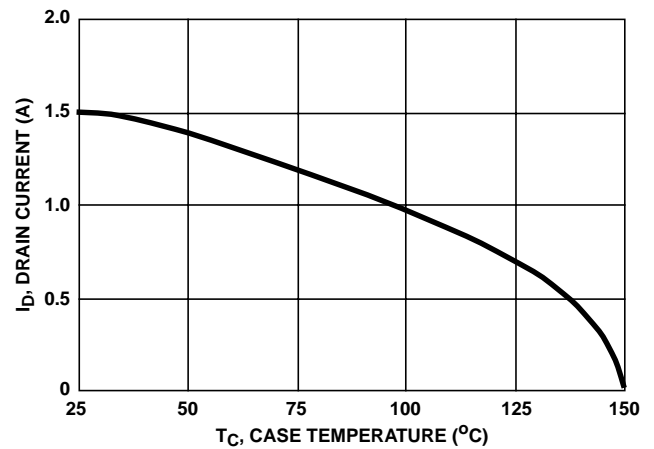

FIGURE 2. MAXIMUM CONTINUOUS DRAIN CURRENT vs CASE TEMPERATURE

Typical Performance Curves Unless Otherwise Specified (Continued)

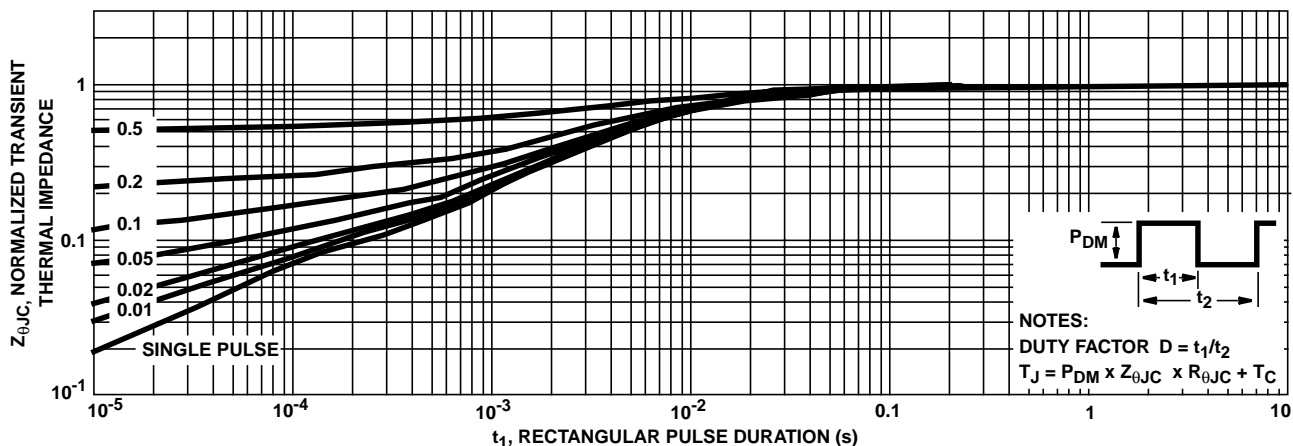

FIGURE 3. NORMALIZED MAXIMUM TRANSIENT THERMAL IMPEDANCE

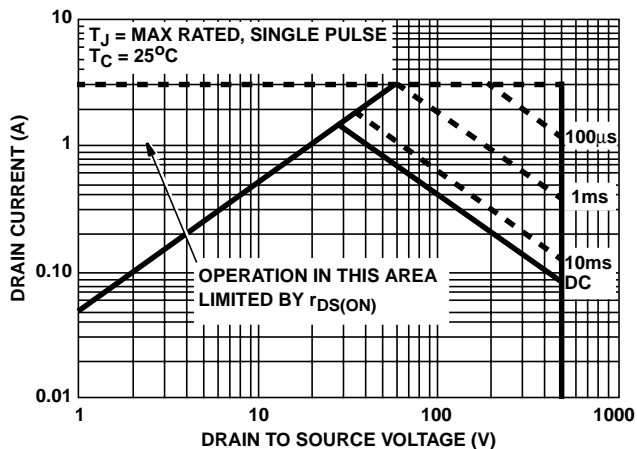

FIGURE 4. FORWARD BIAS SAFE OPERATING AREA

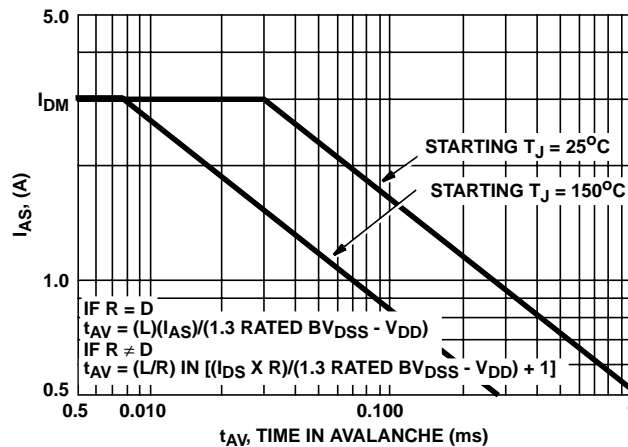

FIGURE 5. UNCLAMPED INDUCTIVE SWITCHING

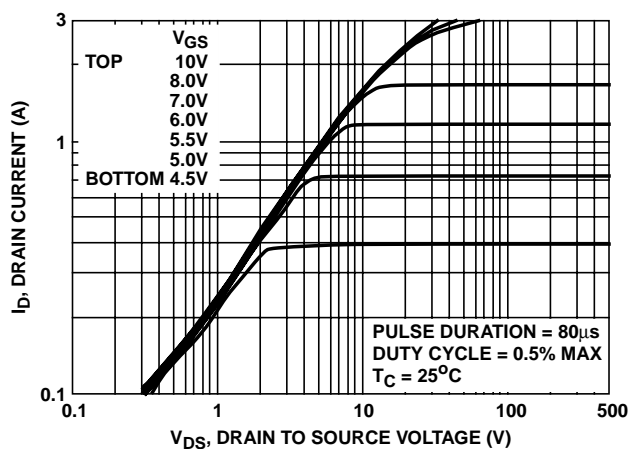

FIGURE 6. OUTPUT CHARACTERISTICS,  $T_C = 25^\circ\text{C}$

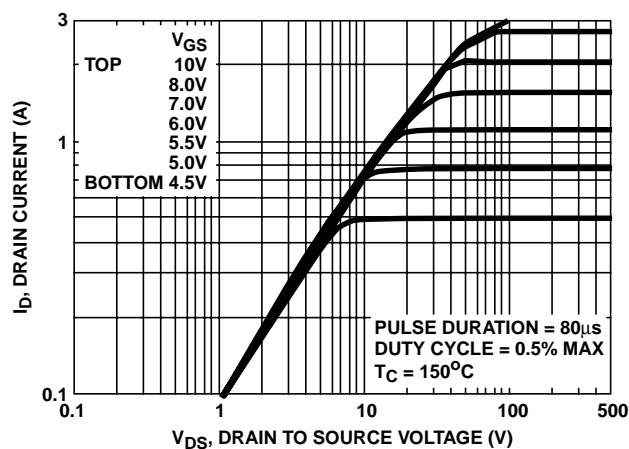

FIGURE 7. OUTPUT CHARACTERISTICS,  $T_C = 150^\circ\text{C}$

Typical Performance Curves Unless Otherwise Specified (Continued)

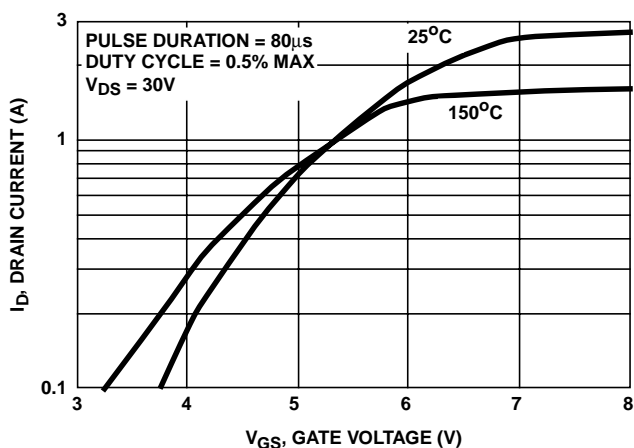

FIGURE 8. TRANSFER CHARACTERISTICS

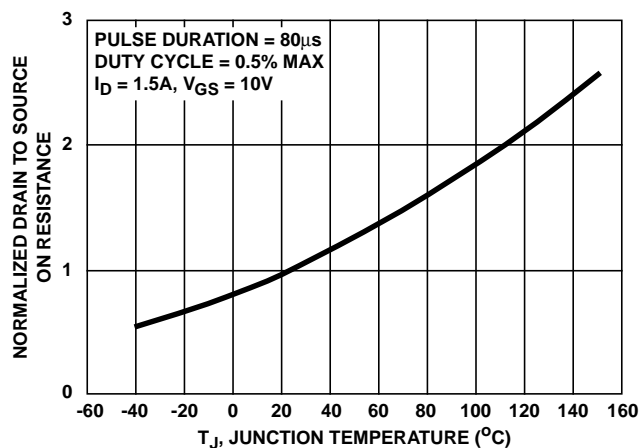

FIGURE 9. NORMALIZED DRAIN TO SOURCE ON RESISTANCE vs JUNCTION TEMPERATURE

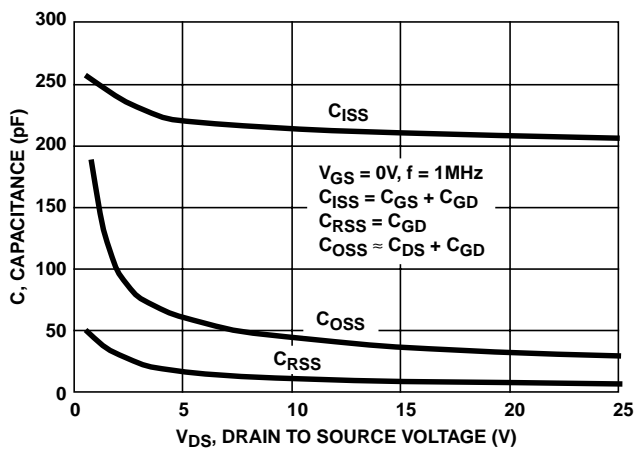

FIGURE 10. CAPACITANCE vs DRAIN TO SOURCE VOLTAGE

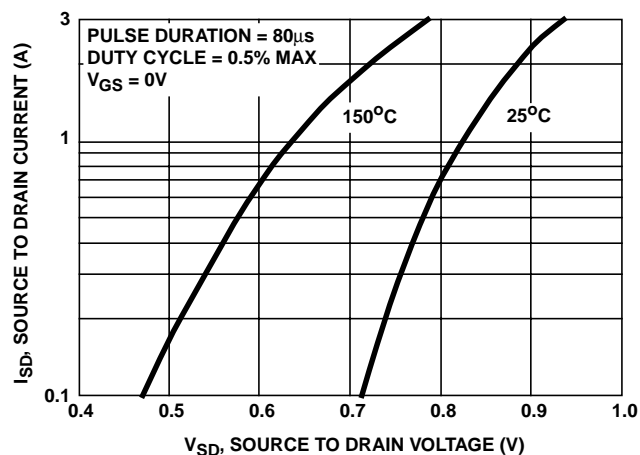

FIGURE 11. SOURCE TO DRAIN DIODE VOLTAGE

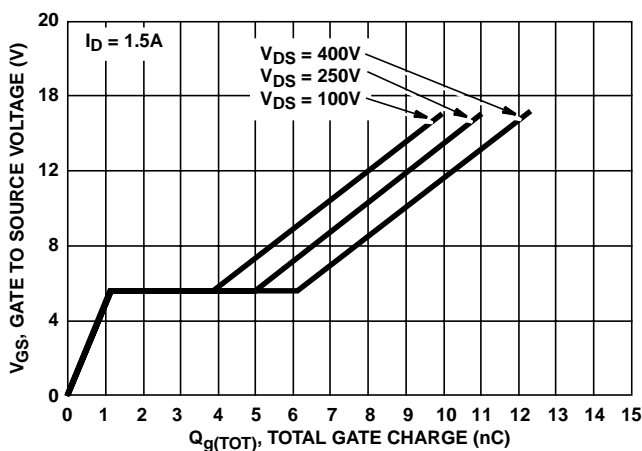

FIGURE 12. GATE TO SOURCE VOLTAGE vs GATE CHARGE

Test Circuits and Waveforms

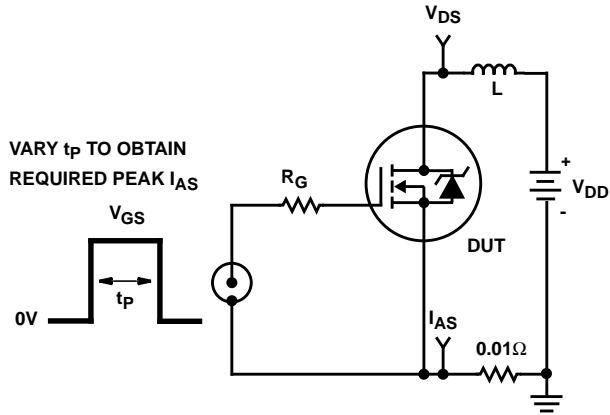

FIGURE 13. UNCLAMPED ENERGY TEST CIRCUIT

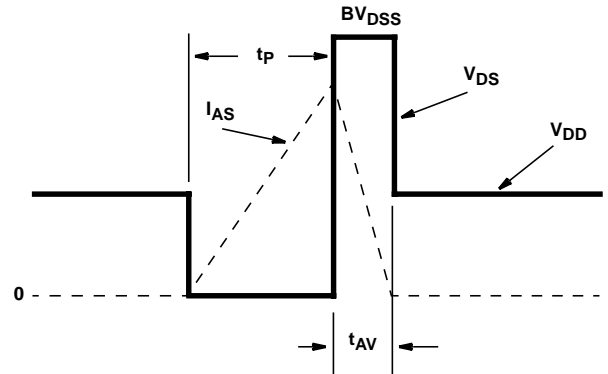

FIGURE 14. UNCLAMPED ENERGY WAVEFORMS

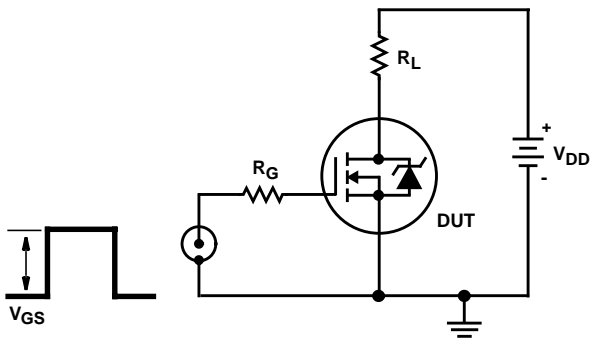

FIGURE 15. SWITCHING TIME TEST CIRCUIT

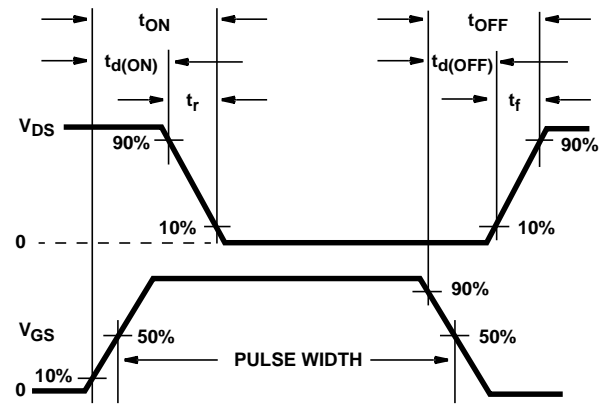

FIGURE 16. RESISTIVE SWITCHING WAVEFORMS

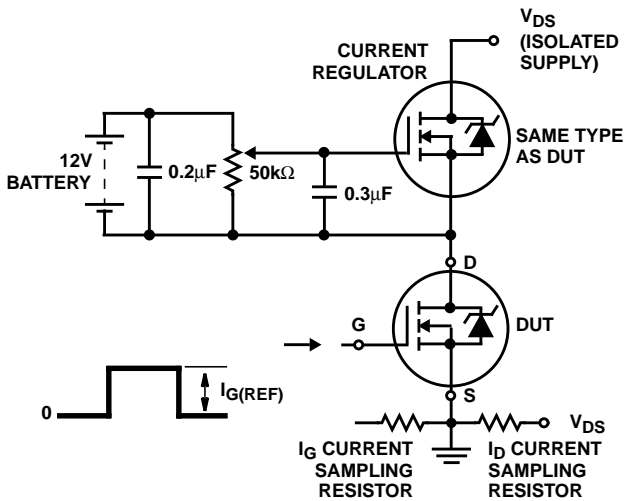

FIGURE 17. GATE CHARGE TEST CIRCUIT

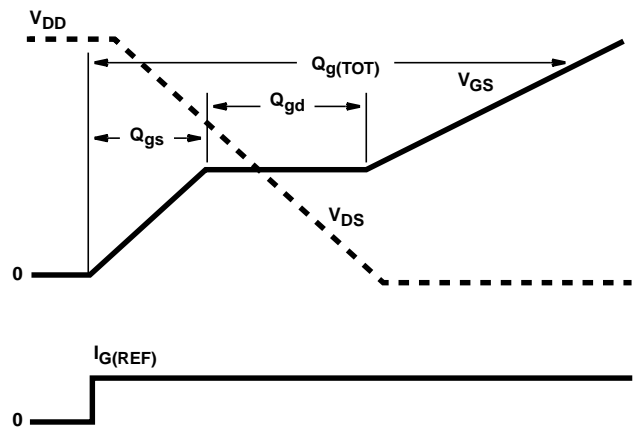

FIGURE 18. GATE CHARGE WAVEFORMS

All Intersil semiconductor products are manufactured, assembled and tested under **ISO9000** quality systems certification.

*Intersil semiconductor products are sold by description only. Intersil Corporation reserves the right to make changes in circuit design and/or specifications at any time without notice. Accordingly, the reader is cautioned to verify that data sheets are current before placing orders. Information furnished by Intersil is believed to be accurate and reliable. However, no responsibility is assumed by Intersil or its subsidiaries for its use; nor for any infringements of patents or other rights of third parties which may result from its use. No license is granted by implication or otherwise under any patent or patent rights of Intersil or its subsidiaries.*

For information regarding Intersil Corporation and its products, see web site <http://www.intersil.com>

### **Sales Office Headquarters**

#### **NORTH AMERICA**

Intersil Corporation  
P. O. Box 883, Mail Stop 53-204  
Melbourne, FL 32902  
TEL: (407) 724-7000  
FAX: (407) 724-7240

#### **EUROPE**

Intersil SA  
Mercure Center  
100, Rue de la Fusee  
1130 Brussels, Belgium  
TEL: (32) 2.724.2111  
FAX: (32) 2.724.22.05

#### **ASIA**

Intersil (Taiwan) Ltd.  
7F-6, No. 101 Fu Hsing North Road  
Taipei, Taiwan  
Republic of China  
TEL: (886) 2 2716 9310  
FAX: (886) 2 2715 3029