

Applications

- High frequency DC-DC converters

V_{DSS}	R_{DS(on) max}	I_D
150V	0.032Ω	60A

Benefits

- Low Gate-to-Drain Charge to Reduce Switching Losses
- Fully Characterized Capacitance Including Effective C_{OSS} to Simplify Design, (See App. Note AN1001)
- Fully Characterized Avalanche Voltage and Current

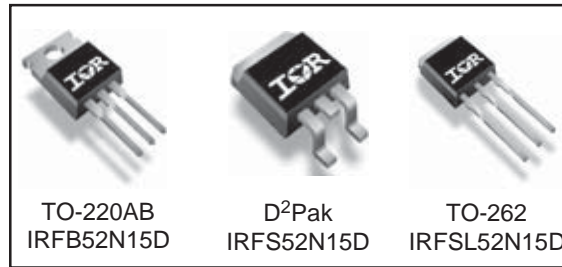

Absolute Maximum Ratings

	Parameter	Max.	Units
I _D @ T _C = 25°C	Continuous Drain Current, V _{GS} @ 10V	60	A
I _D @ T _C = 100°C	Continuous Drain Current, V _{GS} @ 10V	43	
I _{DM}	Pulsed Drain Current ①	240	
P _D @ T _A = 25°C	Power Dissipation ②	3.8	W
P _D @ T _C = 25°C	Power Dissipation	320	
	Linear Derating Factor	2.1	W/°C
V _{GS}	Gate-to-Source Voltage	± 30	V
dv/dt	Peak Diode Recovery dv/dt ③	5.5	V/ns
T _J	Operating Junction and	-55 to + 175	°C
T _{STG}	Storage Temperature Range		
	Soldering Temperature, for 10 seconds	300 (1.6mm from case)	
	Mounting torque, 6-32 or M3 screw④	10 lbf•in (1.1N•m)	

Thermal Resistance

	Parameter	Typ.	Max.	Units
R _{θJC}	Junction-to-Case	—	0.47	°C/W
R _{θCS}	Case-to-Sink, Flat, Greased Surface ⑤	0.50	—	
R _{θJA}	Junction-to-Ambient⑥	—	62	
R _{θJA}	Junction-to-Ambient⑦	—	40	

Notes ① through ⑦ are on page 11

Static @ $T_J = 25^\circ\text{C}$ (unless otherwise specified)

	Parameter	Min.	Typ.	Max.	Units	Conditions
$V_{(BR)DSS}$	Drain-to-Source Breakdown Voltage	150	—	—	V	$V_{GS} = 0V, I_D = 250\mu A$
$\Delta V_{(BR)DSS}/\Delta T_J$	Breakdown Voltage Temp. Coefficient	—	0.16	—	V/°C	Reference to $25^\circ\text{C}, I_D = 1\text{mA}$
$R_{DS(on)}$	Static Drain-to-Source On-Resistance	—	—	0.032	Ω	$V_{GS} = 10V, I_D = 36A$ ④
$V_{GS(th)}$	Gate Threshold Voltage	3.0	—	5.0	V	$V_{DS} = V_{GS}, I_D = 250\mu A$
I_{DSS}	Drain-to-Source Leakage Current	—	—	25	μA	$V_{DS} = 150V, V_{GS} = 0V$
		—	—	250		$V_{DS} = 120V, V_{GS} = 0V, T_J = 150^\circ\text{C}$
I_{GSS}	Gate-to-Source Forward Leakage	—	—	100	nA	$V_{GS} = 30V$
	Gate-to-Source Reverse Leakage	—	—	-100		$V_{GS} = -30V$

Dynamic @ $T_J = 25^\circ\text{C}$ (unless otherwise specified)

	Parameter	Min.	Typ.	Max.	Units	Conditions
g_{fs}	Forward Transconductance	19	—	—	S	$V_{DS} = 50V, I_D = 36A$
Q_g	Total Gate Charge	—	60	89	nC	$I_D = 36A$
Q_{gs}	Gate-to-Source Charge	—	18	27		$V_{DS} = 75V$
Q_{gd}	Gate-to-Drain ("Miller") Charge	—	28	42		$V_{GS} = 10V$, ④
$t_{d(on)}$	Turn-On Delay Time	—	16	—	ns	$V_{DD} = 75V$
t_r	Rise Time	—	47	—		$I_D = 36A$
$t_{d(off)}$	Turn-Off Delay Time	—	28	—		$R_G = 2.5\Omega$
t_f	Fall Time	—	25	—		$V_{GS} = 10V$ ④
C_{iss}	Input Capacitance	—	2770	—	pF	$V_{GS} = 0V$
C_{oss}	Output Capacitance	—	590	—		$V_{DS} = 25V$
C_{riss}	Reverse Transfer Capacitance	—	110	—		$f = 1.0\text{MHz}$
C_{oss}	Output Capacitance	—	3940	—		$V_{GS} = 0V, V_{DS} = 1.0V, f = 1.0\text{MHz}$
C_{oss}	Output Capacitance	—	260	—		$V_{GS} = 0V, V_{DS} = 120V, f = 1.0\text{MHz}$
$C_{oss\ eff.}$	Effective Output Capacitance	—	550	—		$V_{GS} = 0V, V_{DS} = 0V \text{ to } 120V$ ⑤

Avalanche Characteristics

	Parameter	Typ.	Max.	Units
E_{AS}	Single Pulse Avalanche Energy②⑥	—	470	mJ
I_{AR}	Avalanche Current①	—	36	A
E_{AR}	Repetitive Avalanche Energy①	—	32	mJ

Diode Characteristics

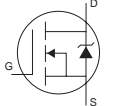
	Parameter	Min.	Typ.	Max.	Units	Conditions
I_S	Continuous Source Current (Body Diode)	—	—	60	A	MOSFET symbol showing the integral reverse p-n junction diode. 
I_{SM}	Pulsed Source Current (Body Diode) ①⑥	—	—	240		
V_{SD}	Diode Forward Voltage	—	—	1.5	V	$T_J = 25^\circ\text{C}, I_S = 36A, V_{GS} = 0V$ ④
t_{rr}	Reverse Recovery Time	—	140	210	nS	$T_J = 25^\circ\text{C}, I_F = 36A$
Q_{rr}	Reverse Recovery Charge	—	780	1170	nC	$di/dt = 100A/\mu s$ ④
t_{on}	Forward Turn-On Time	Intrinsic turn-on time is negligible (turn-on is dominated by $L_S + L_D$)				

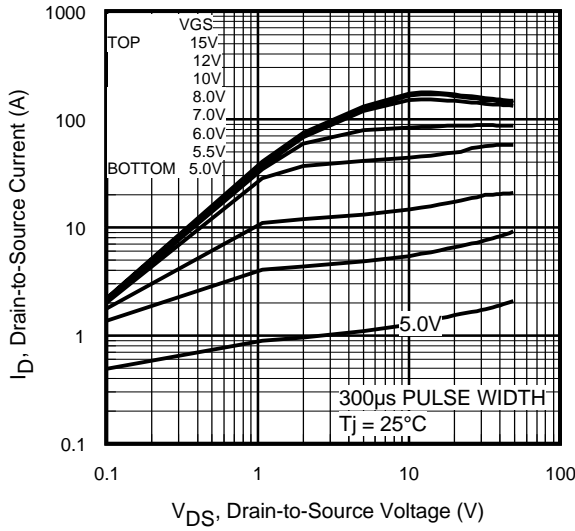

Fig 1. Typical Output Characteristics

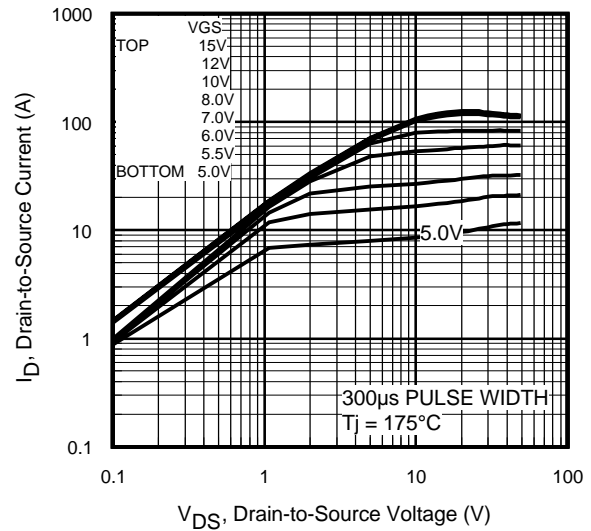

Fig 2. Typical Output Characteristics

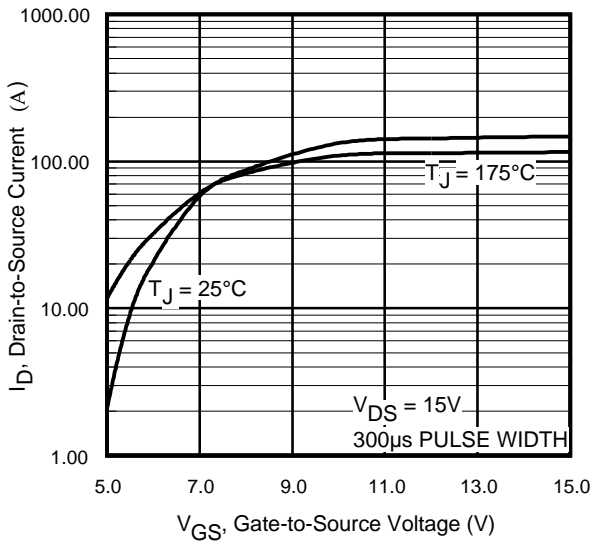

Fig 3. Typical Transfer Characteristics

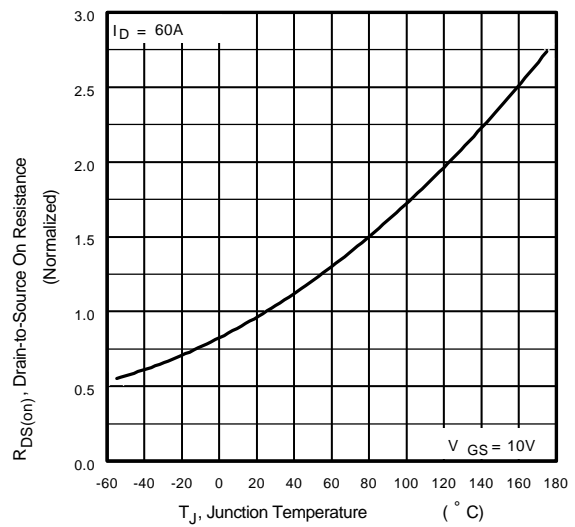

Fig 4. Normalized On-Resistance Vs. Temperature

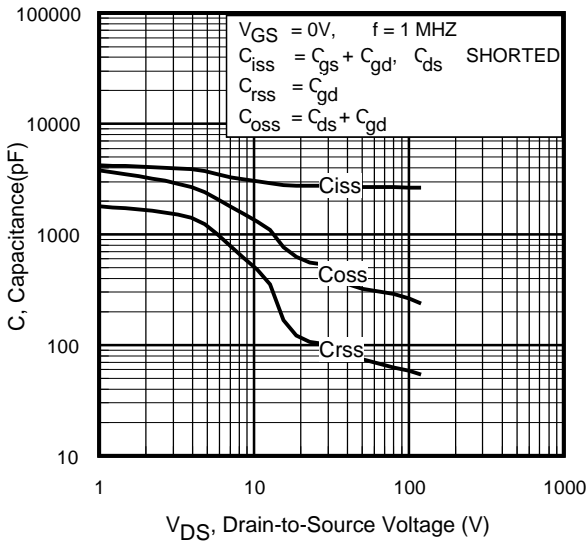

Fig 5. Typical Capacitance Vs. Drain-to-Source Voltage

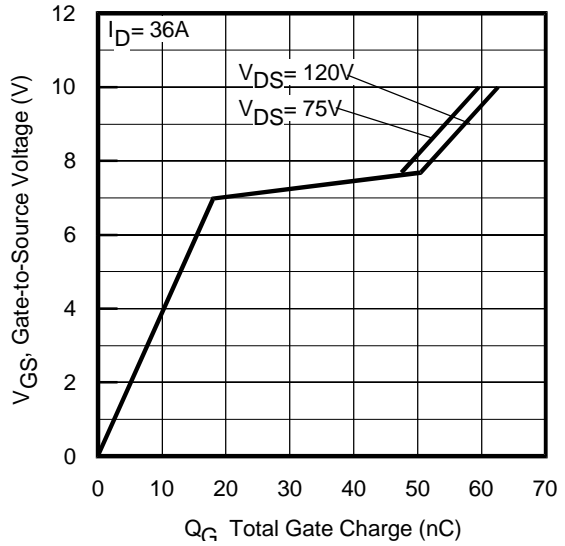

Fig 6. Typical Gate Charge Vs. Gate-to-Source Voltage

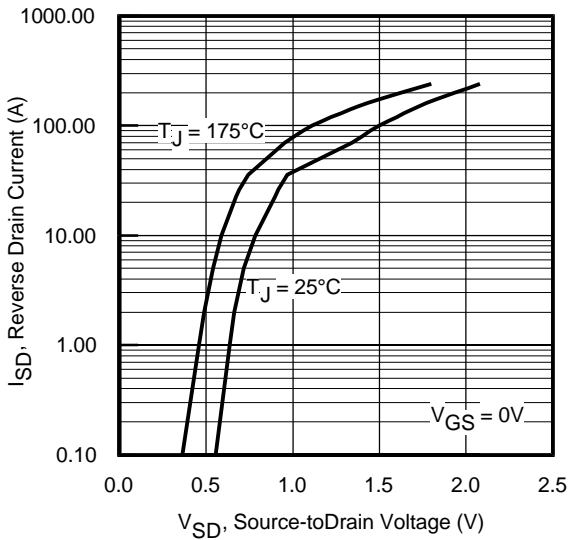

Fig 7. Typical Source-Drain Diode Forward Voltage

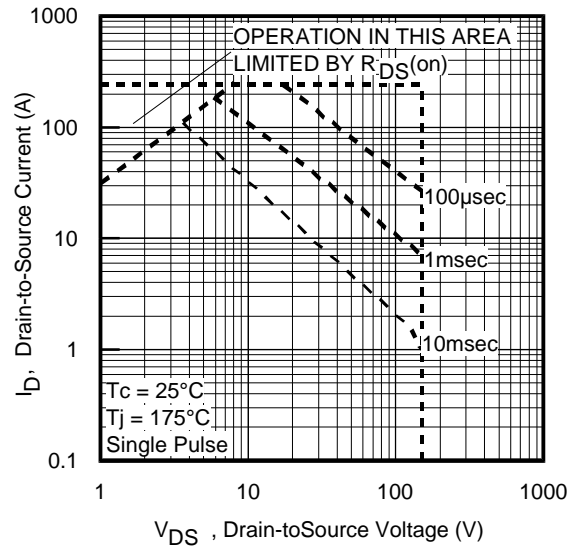

Fig 8. Maximum Safe Operating Area

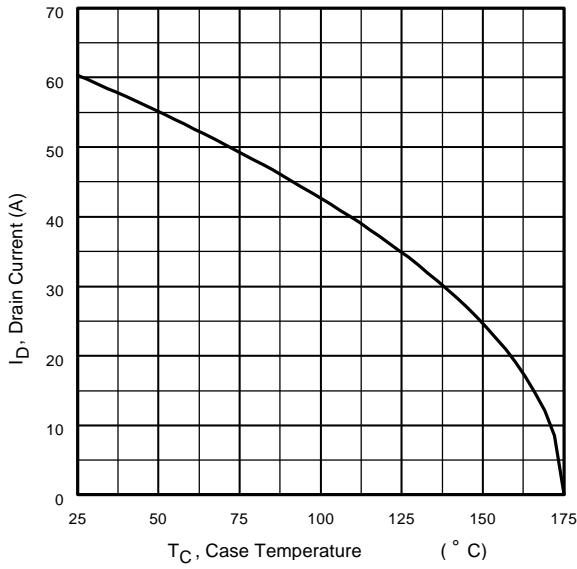

Fig 9. Maximum Drain Current Vs. Case Temperature

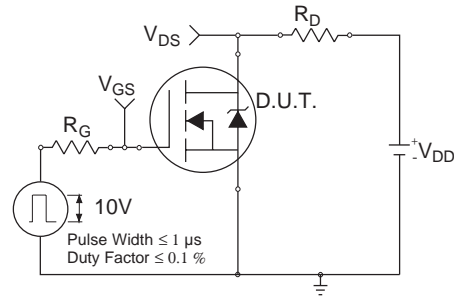

Fig 10a. Switching Time Test Circuit

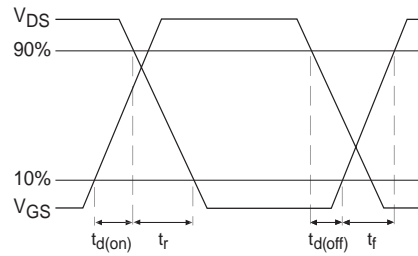

Fig 10b. Switching Time Waveforms

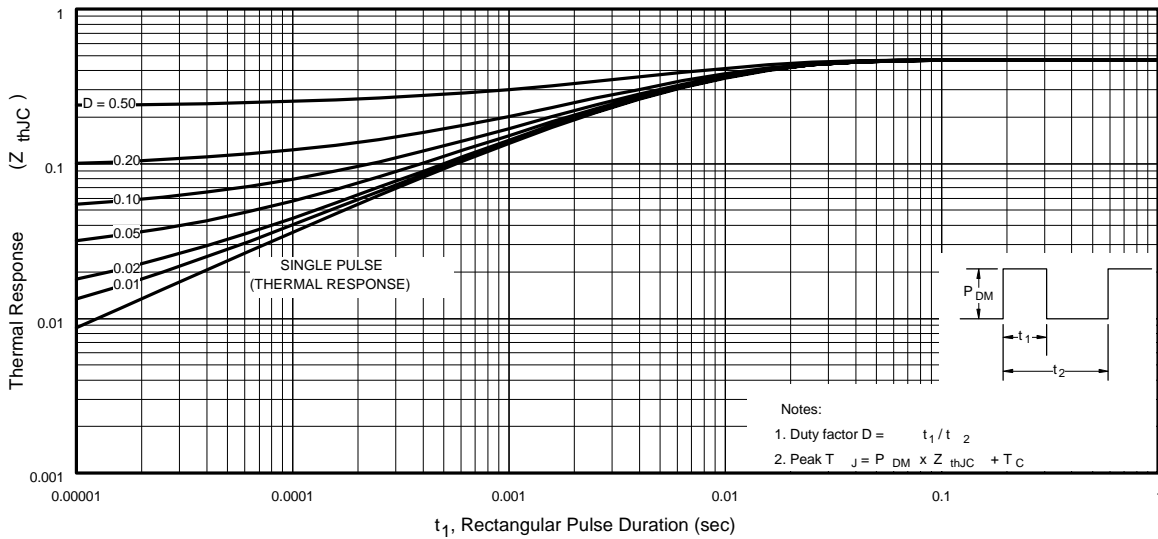

Fig 11. Maximum Effective Transient Thermal Impedance, Junction-to-Case

IRFB/IRFS/IRFSL52N15D

International
IR Rectifier

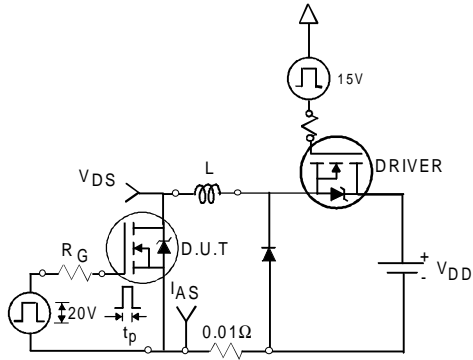

Fig 12a. Unclamped Inductive Test Circuit

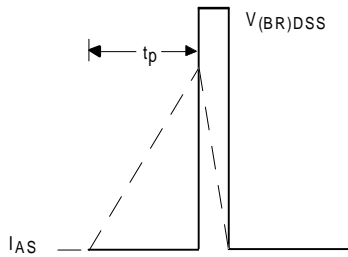

Fig 12b. Unclamped Inductive Waveforms

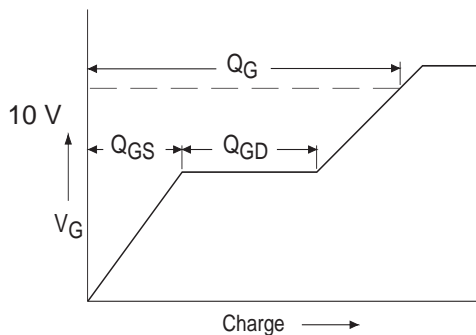

Fig 13a. Basic Gate Charge Waveform

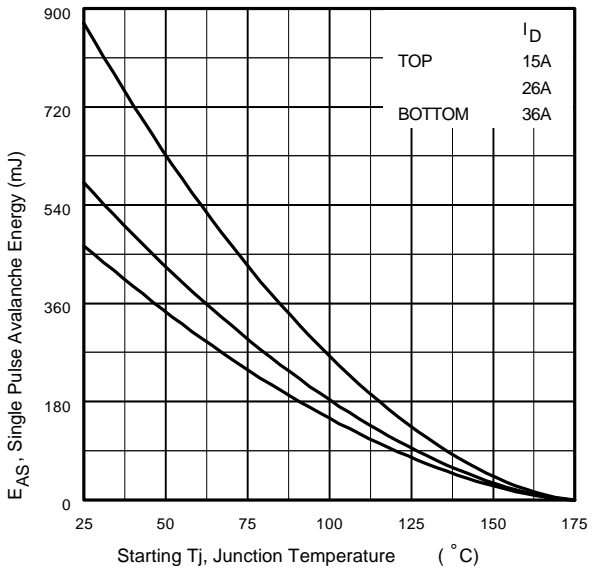

Fig 12c. Maximum Avalanche Energy Vs. Drain Current

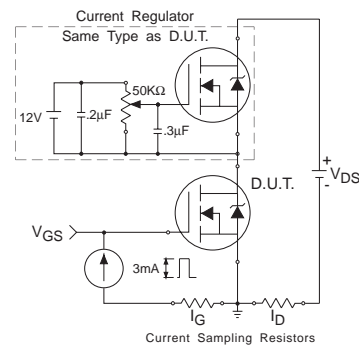
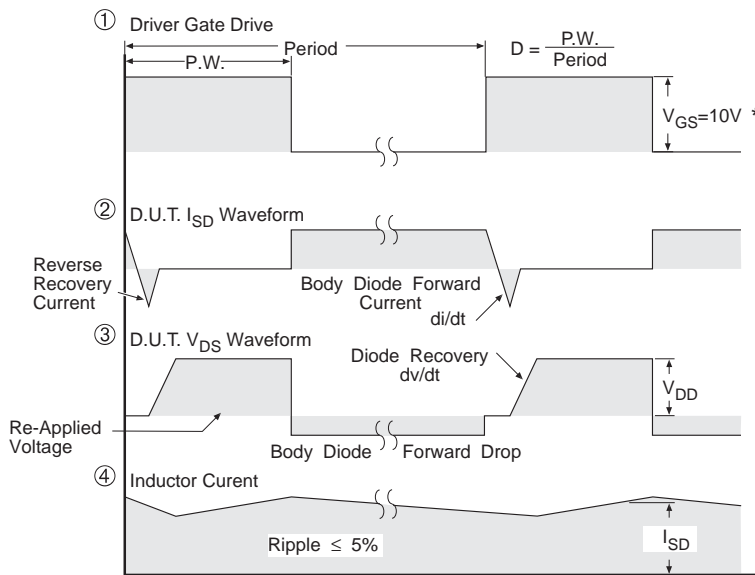
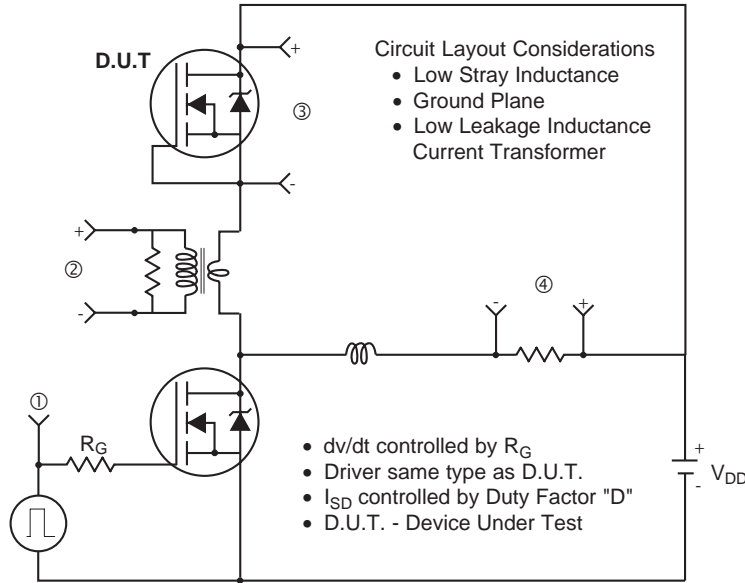

Fig 13b. Gate Charge Test Circuit

Peak Diode Recovery dv/dt Test Circuit



* $V_{GS} = 5V$ for Logic Level Devices

Fig 14. For N-Channel HEXFET® Power MOSFETs

IRFB/IRFS/IRFSL52N15D



TO-220AB Package Outline

Dimensions are shown in millimeters (inches)

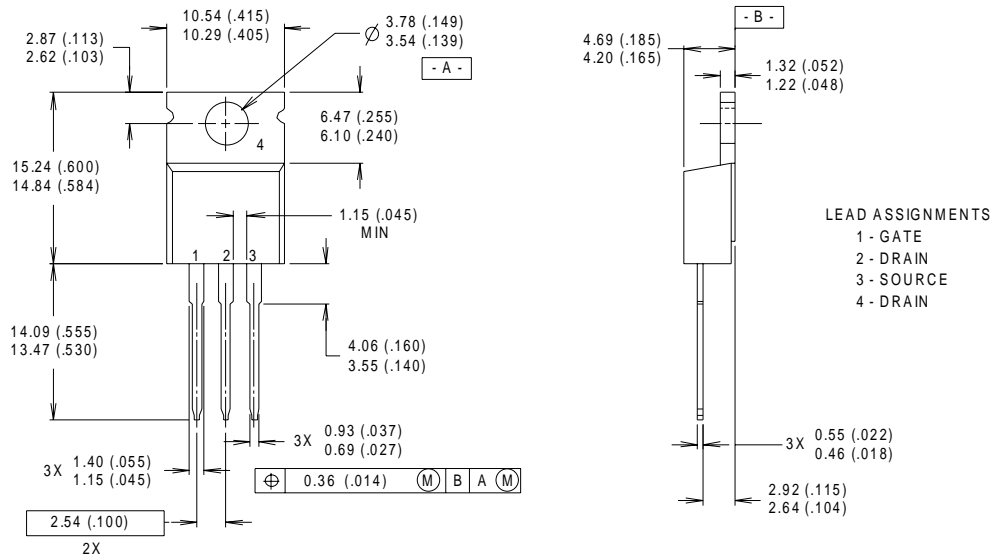

NOTES:

- 1 DIMENSIONING & TOLERANCING PER ANS Y14.5M, 1982.
- 2 CONTROLLING DIMENSION : INCH

- 3 OUTLINE CONFORMS TO JEDEC OUTLINE TO-220AB.
- 4 HEATSINK & LEAD MEASUREMENTS DO NOT INCLUDE BURRS.

TO-220AB Part Marking Information

EXAMPLE: THIS IS AN IRF1010
 LOT CODE 1789
 ASSEMBLED ON WW19, 1997
 IN THE ASSEMBLY LINE "C"

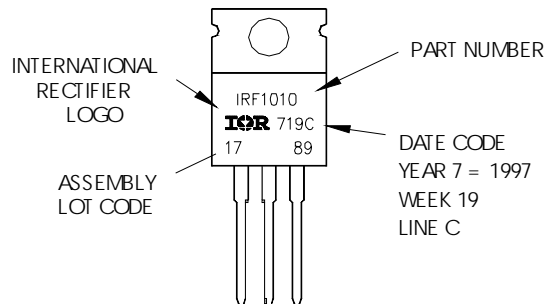

D²Pak Package Outline

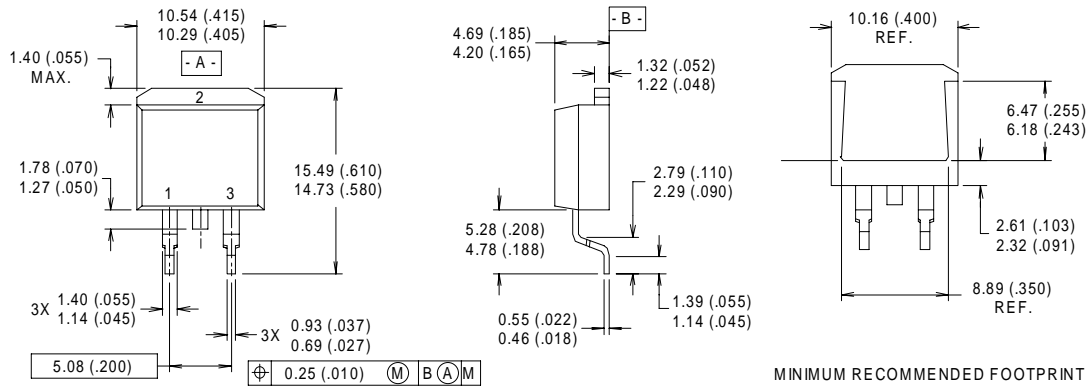

NOTES:

- 1 DIMENSIONS AFTER SOLDER DIP.
- 2 DIMENSIONING & TOLERANCING PER ANSI Y14.5M, 1982.
- 3 CONTROLLING DIMENSION : INCH.
- 4 HEATSINK & LEAD DIMENSIONS DO NOT INCLUDE BURRS.

LEAD ASSIGNMENTS

- 1 - GATE
- 2 - DRAIN
- 3 - SOURCE

D²Pak Part Marking Information

EXAMPLE: THIS IS AN IRF530S WITH
 LOT CODE 8024
 ASSEMBLED ON WW02, 2000
 IN THE ASSEMBLY LINE "L"

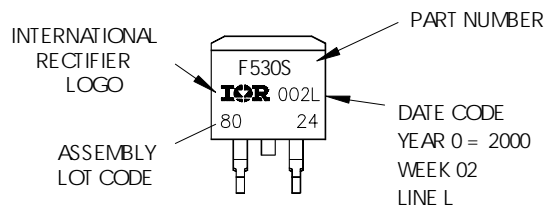

IRFB/IRFS/IRFSL52N15D



TO-262 Package Outline

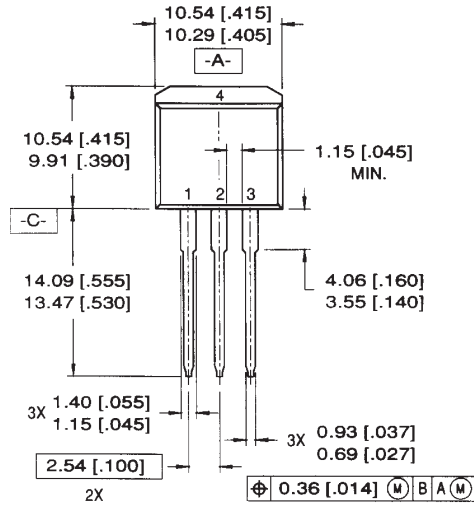

LEAD ASSIGNMENTS

- | | |
|-----------|------------|
| 1 = GATE | 3 = SOURCE |
| 2 = DRAIN | 4 = DRAIN |

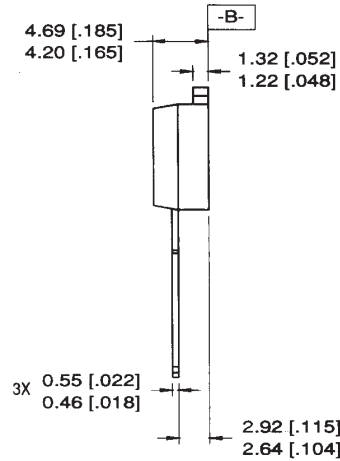

NOTES:

1. DIMENSIONING & TOLERANCING PER ANSI Y14.5M-1982
2. CONTROLLING DIMENSION: INCH.
3. DIMENSIONS ARE SHOWN IN MILLIMETERS [INCHES].
4. HEATSINK & LEAD DIMENSIONS DO NOT INCLUDE BURRS.

TO-262 Part Marking Information

EXAMPLE: THIS IS AN IRL3103L
 LOT CODE 1789
 ASSEMBLED ON VW 19, 1997
 IN THE ASSEMBLY LINE "C"

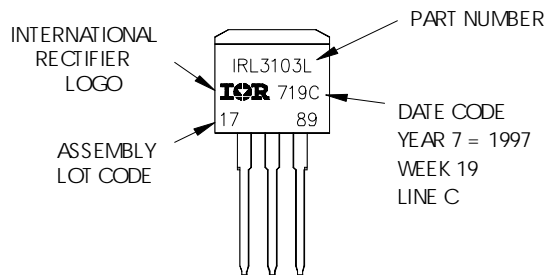

D²Pak Tape & Reel Information

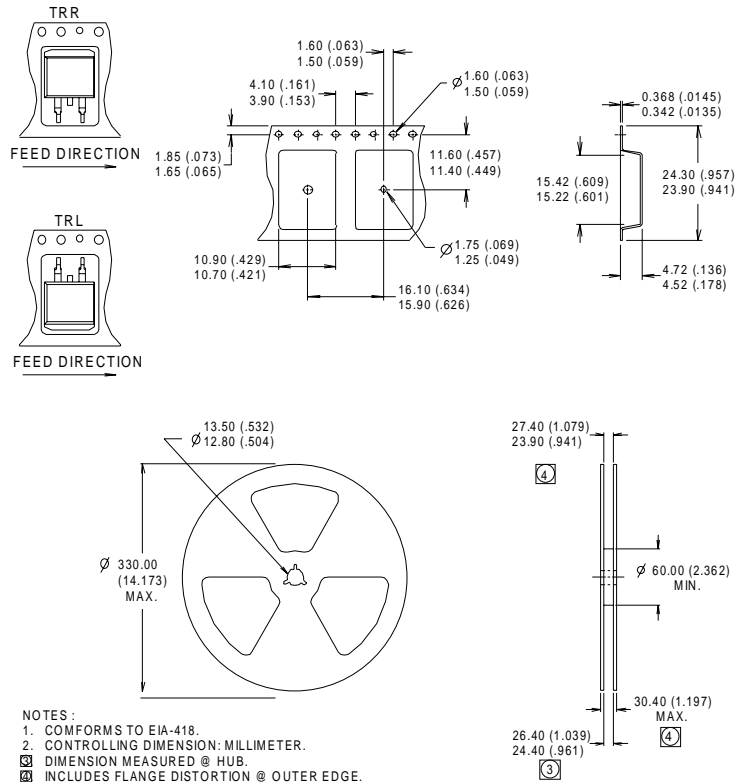

Notes:

- ① Repetitive rating; pulse width limited by max. junction temperature.
- ② Starting $T_J = 25^\circ\text{C}$, $L = 0.72\text{mH}$
 $R_G = 25\Omega$, $I_{AS} = 36\text{A}$.
- ③ $I_{SD} \leq 36\text{A}$, $di/dt \leq 400\text{A}/\mu\text{s}$, $V_{DD} \leq V_{(BR)DSS}$,
 $T_J \leq 175^\circ\text{C}$.
- ④ Pulse width $\leq 300\mu\text{s}$; duty cycle $\leq 2\%$.
- ⑤ C_{OSS} eff. is a fixed capacitance that gives the same charging time as C_{OSS} while V_{DS} is rising from 0 to 80% V_{DSS} .
- ⑥ This is only applied to TO-220AB package.
- ⑦ This is applied to D²Pak, when mounted on 1" square PCB (FR-4 or G-10 Material). For recommended footprint and soldering techniques refer to application note #AN-994.

TO-220 package is not recommended for Surface Mount Application.

Data and specifications subject to change without notice.
 This product has been designed and qualified for the Automotive [Q101] (IRFB52N15D),
 & Industrial (IRFS/SL52N15D) market.
 Qualification Standards can be found on IR's Web site.

Note: For the most current drawings please refer to the IR website at:
<http://www.irf.com/package/>