

HEXFET® Power MOSFET for DC-DC Converters

- N-Channel Application-Specific MOSFETs
- Ideal for CPU Core DC-DC Converters
- Low Conduction Losses
- Low Switching Losses

Description

This new device employs advanced HEXFET Power MOSFET technology to achieve an unprecedented balance of on-resistance and gate charge. The reduced conduction and switching losses make it ideal for high efficiency DC-DC converters that power the latest generation of microprocessors.

The IRF7828 has been optimized for all parameters that are critical in synchronous buck converters including $R_{DS(on)}$, gate charge and Cdv/dt -induced turn-on immunity. The IRF7828 offers particularly low $R_{DS(on)}$ and high Cdv/dt immunity for synchronous FET applications.

The package is designed for vapor phase, infra-red, convection, or wave soldering techniques. Power dissipation of greater than 3W is possible in a typical PCB mount application.

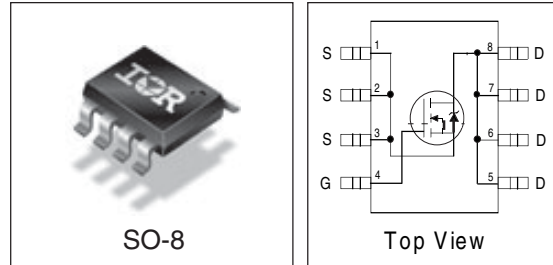

DEVICE CHARACTERISTICS^⑤

IRF7828	
$R_{DS(on)}$	9.5mΩ
Q_G	9.2nC
Q_{sw}	3.7nC
Q_{oss}	6.1nC

Absolute Maximum Ratings

Parameter	Symbol	IRF7828	Units
Drain-Source Voltage	V_{DS}	30	V
Gate-Source Voltage	V_{GS}	±20	
Continuous Drain or Source Current ($V_{GS} \geq 4.5V$)	I_D	$T_A = 25^\circ C$	13.6
		$T_L = 70^\circ C$	11
Pulsed Drain Current ^①	I_{DM}	100	A
Power Dissipation	P_D	$T_A = 25^\circ C$	2.5
		$T_L = 70^\circ C$	1.6
Junction & Storage Temperature Range	T_J, T_{STG}	-55 to 150	°C
Continuous Source Current (Body Diode)	I_S	3.1	A
Pulsed Source Current ^①	I_{SM}	100	

Thermal Resistance

Parameter		Max.	Units
Maximum Junction-to-Ambient ^③	$R_{\theta JA}$	50	°C/W
Maximum Junction-to-Lead	$R_{\theta JL}$	20	°C/W

IRF7828

International
IR Rectifier

Electrical Characteristics

Parameter		Min	Typ	Max	Units	Conditions
Drain-to-Source Breakdown Voltage	BV_{DSS}	30	-	-	V	$V_{GS} = 0V, I_D = 250\mu A$
Static Drain-Source on Resistance	$R_{DS(on)}$	-	9.5	12.5	m Ω	$V_{GS} = 4.5V, I_D = 10A$ ②
Gate Threshold Voltage	$V_{GS(th)}$	1.0	-	-	V	$V_{DS} = V_{GS}, I_D = 250\mu A$
Drain-Source Leakage Current	I_{DSS}	-	-	1.0	μA	$V_{DS} = 24V, V_{GS} = 0$
		-	-	150		$V_{DS} = 24V, V_{GS} = 0,$ $T_j = 125^\circ C$
Gate-Source Leakage Current	I_{GSS}	-	-	± 100	nA	$V_{GS} = \pm 20V$
Total Gate Chg Cont FET	Q_G	-	9.2	14	nC	$V_{GS} = 5.0V, I_D = 15A, V_{DS} = 16V$
Total Gate Chg Sync FET	Q_G	-	7.3	-		$V_{GS} = 5V, V_{DS} < 100mV$
Pre-Vth Gate-Source Charge	Q_{GS1}	-	2.5	-		$V_{DS} = 15V, I_D = 10A$
Post-Vth Gate-Source Charge	Q_{GS2}	-	0.8	-		
Gate to Drain Charge	Q_{GD}	-	2.9	-		
Switch Chg($Q_{gs2} + Q_{gd}$)	Q_{sw}	-	3.7	-		
Output Charge	Q_{oss}	-	6.1	-		$V_{DS} = 10V, V_{GS} = 0$
Gate Resistance	R_G	-	2.3	-	Ω	
Turn-on Delay Time	$t_{d(on)}$	-	6.3	-	ns	$V_{DD} = 15V, I_D = 10A$ $V_{GS} = 4.5V$ Clamped Inductive Load
Rise Time	t_r	-	2.7	-		
Turn-off Delay Time	$t_{d(off)}$	-	9.7	-		
Fall Time	t_f	-	7.3	-		
Input Capacitance	C_{iss}	-	1010	-	pF	$V_{DS} = 15V, V_{GS} = 0$
Output Capacitance	C_{oss}	-	360	-		
Reverse Transfer Capacitance	C_{rss}	-	110	-		

Source-Drain Rating & Characteristics

Parameter		Min	Typ	Max	Units	Conditions
Diode Forward Voltage*	V_{SD}	-	-	1.0	V	$I_S = 10A$ ②, $V_{GS} = 0V$
Reverse Recovery Charge④	Q_{rr}	-	13	-	nC	$di/dt \sim 700A/\mu s$ $V_{DS} = 16V, V_{GS} = 0V, I_S = 15A$
Reverse Recovery Charge (with Parallel Schottky)④	$Q_{rr(s)}$	-	13	-	nC	$di/dt = 700A/\mu s$ (with 10BQ040) $V_{DS} = 16V, V_{GS} = 0V, I_S = 15A$

- Notes:**
- ① Repetitive rating; pulse width limited by max. junction temperature.
 - ② Pulse width $\leq 400 \mu s$; duty cycle $\leq 2\%$.
 - ③ When mounted on 1 inch square copper board
 - ④ Typ = measured - Q_{oss}
 - ⑤ Typical values of $R_{DS(on)}$ measured at $V_{GS} = 4.5V, Q_G, Q_{sw}$ and Q_{oss} measured at $V_{GS} = 5.0V, I_F = 10A$.

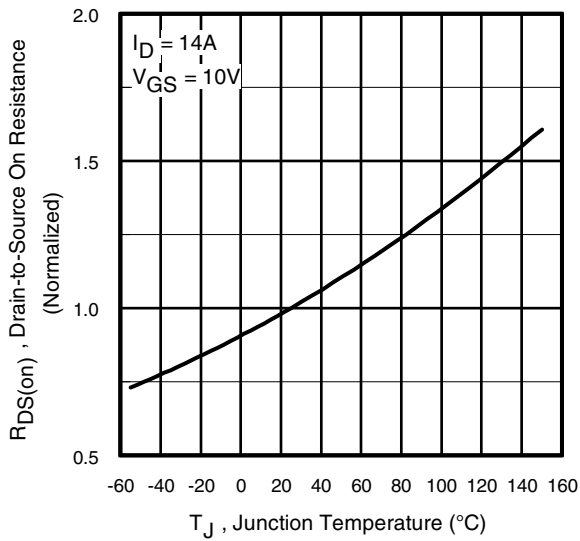

Fig 1. Normalized On-Resistance Vs. Temperature

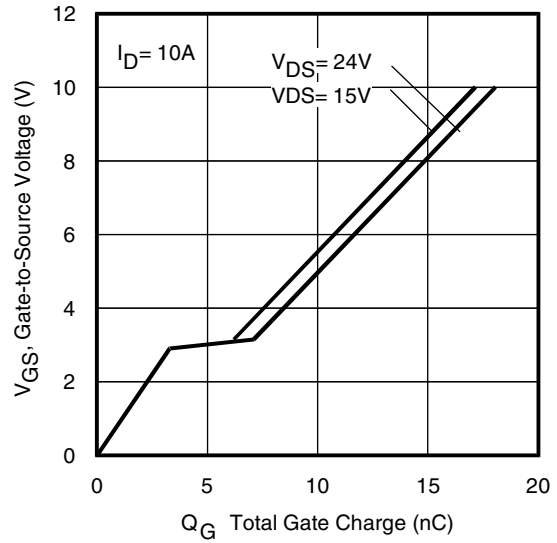

Fig 2. Typical Gate Charge Vs. Gate-to-Source Voltage

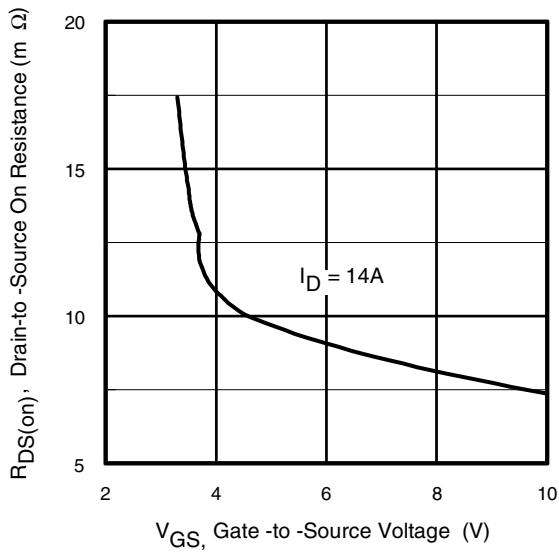

Fig 3. On-Resistance Vs. Gate Voltage

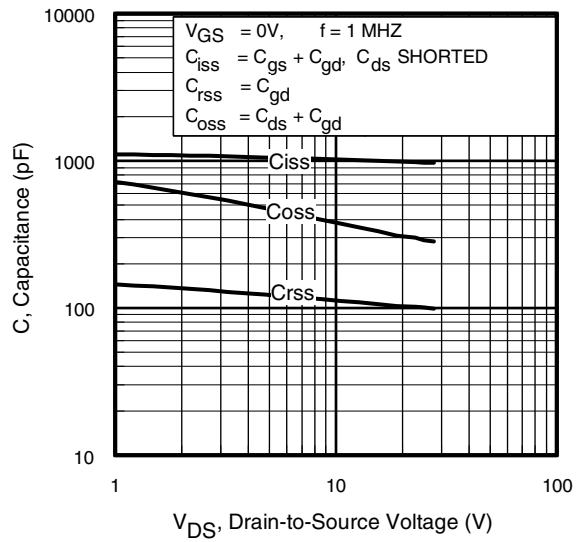
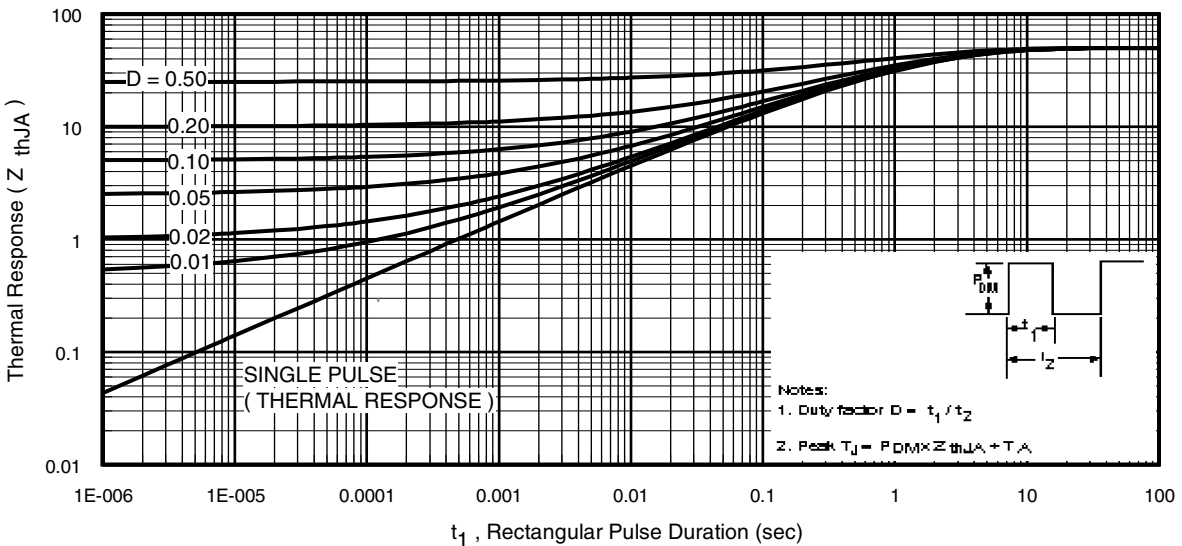
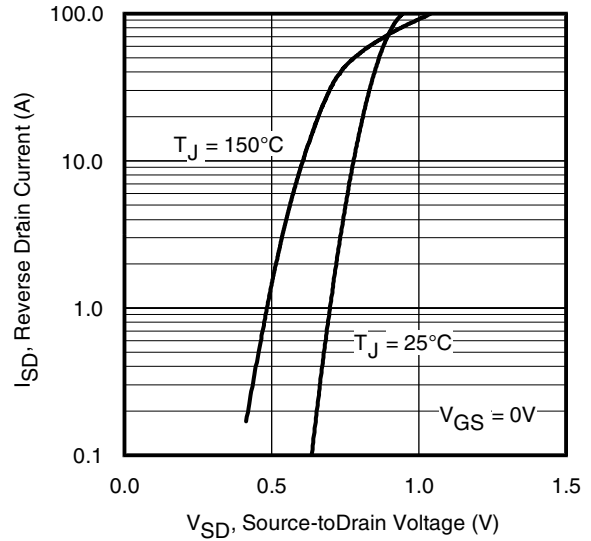
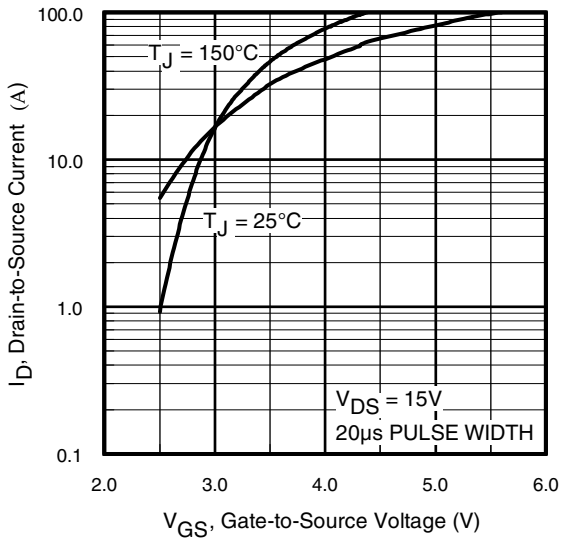
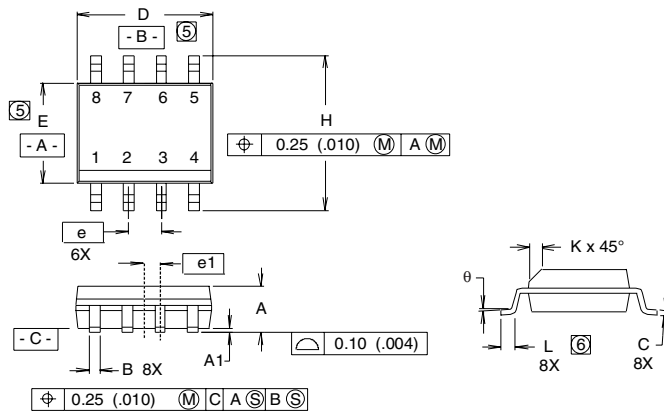

Fig 4. Typical Capacitance Vs. Drain-to-Source Voltage



SO-8 Package Details



DIM	INCHES		MILLIMETERS	
	MIN	MAX	MIN	MAX
A	.0532	.0688	1.35	1.75
A1	.0040	.0098	0.10	0.25
B	.014	.018	0.36	0.46
C	.0075	.0098	0.19	0.25
D	.189	.196	4.80	4.98
E	.150	.157	3.81	3.99
e	.050 BASIC		1.27 BASIC	
e1	.025 BASIC		0.635 BASIC	
H	.2284	.2440	5.80	6.20
K	.011	.019	0.28	0.48
L	0.16	.050	0.41	1.27
θ	0°	8°	0°	8°

RECOMMENDED FOOTPRINT

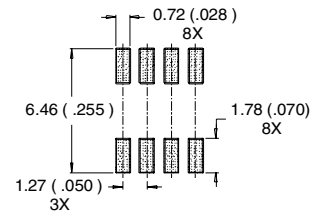

NOTES:

1. DIMENSIONING AND TOLERANCING PER ANSI Y14.5M-1982.
2. CONTROLLING DIMENSION : INCH.
3. DIMENSIONS ARE SHOWN IN MILLIMETERS (INCHES).
4. OUTLINE CONFORMS TO JEDEC OUTLINE MS-012AA.
- 5 DIMENSION DOES NOT INCLUDE MOLD PROTRUSIONS
MOLD PROTRUSIONS NOT TO EXCEED 0.25 (.006).
- 6 DIMENSIONS IS THE LENGTH OF LEAD FOR SOLDERING TO A SUBSTRATE..

SO-8 Part Marking

EXAMPLE: THIS IS AN IRF7101

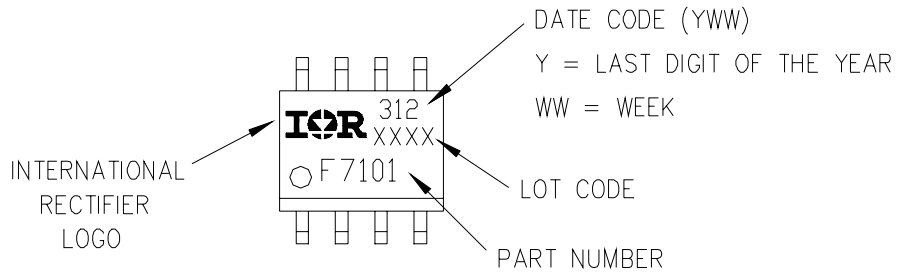

IRF7828

International
IOR Rectifier

SO-8 Tape and Reel

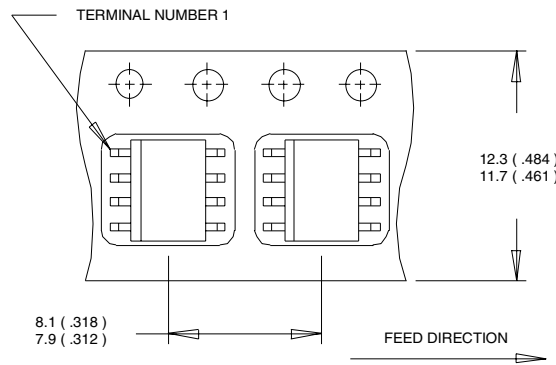

- NOTES:
1. CONTROLLING DIMENSION : MILLIMETER.
 2. ALL DIMENSIONS ARE SHOWN IN MILLIMETERS(INCHES).
 3. OUTLINE CONFORMS TO EIA-481 & EIA-541.

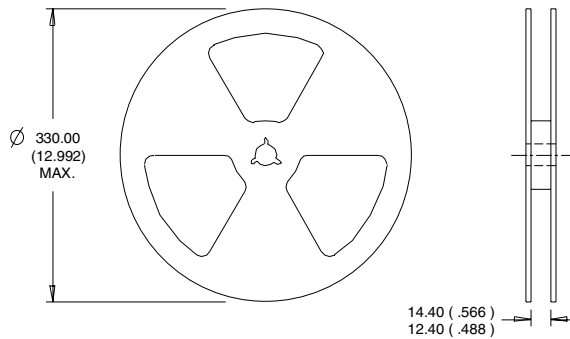

- NOTES :
1. CONTROLLING DIMENSION : MILLIMETER.
 2. OUTLINE CONFORMS TO EIA-481 & EIA-541.

Data and specifications subject to change without notice.
This product has been designed and qualified for the Industrial market.
Qualification Standards can be found on IR's Web site.

International
IOR Rectifier

IR WORLD HEADQUARTERS: 233 Kansas St., El Segundo, California 90245, USA Tel: (310) 252-7105
TAC Fax: (310) 252-7903

Visit us at www.irf.com for sales contact information. 12/02
www.irf.com