



IRF440-443/IRF840-843
MTM7N45/7N50
N-Channel Power MOSFETs,
8 A, 450 V/500 V
 Power And Discrete Division

T-39-11

Description

These devices are n-channel, enhancement mode, power MOSFETs designed especially for high voltage, high speed applications, such as off-line switching power supplies, UPS, AC and DC motor controls, relay and solenoid drivers.

- V_{GS} Rated at ± 20 V
- Silicon Gate for Fast Switching Speeds
- I_{DSS} , $V_{DS(on)}$, SOA and $V_{GS(th)}$ Specified at Elevated Temperature
- Rugged

TO-204AA

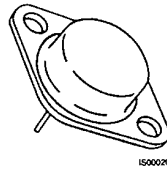

- IRF440
- IRF441
- IRF442
- IRF443
- MTM7N45
- MTM7N50

TO-220AB

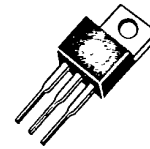

- IRF840
- IRF841
- IRF842
- IRF843

Maximum Ratings

Symbol	Characteristic	Rating IRF440/442 IRF840/842 MTM7N50	Rating IRF441/443 IRF841/843 MTM7N45	Unit
V_{DSS}	Drain to Source Voltage	500	450	V
V_{DGR}	Drain to Gate Voltage $R_{GS} = 20 \text{ k}\Omega$	500	450	V
V_{GS}	Gate to Source Voltage	± 20	± 20	V
T_J, T_{stg}	Operating Junction and Storage Temperature	-55 to +150	-55 to +150	$^{\circ}\text{C}$
T_L	Maximum Lead Temperature for Soldering Purposes, 1/8" From Case for 5 s	275	275	$^{\circ}\text{C}$

Maximum On-State Characteristics

		IRF440/441 IRF840/841	IRF442/443 IRF842/843	MTM7N45 MTM7N50	
$R_{DS(on)}$	Static Drain-to-Source On Resistance	0.85	1.1	0.8	Ω
I_D	Drain Current				A
	Continuous	8	7	7	
	Pulsed	32	28	40	

Maximum Thermal Characteristics

$R_{\theta JC}$	Thermal Resistance, Junction to Case	1.0	1.0	0.83	$^{\circ}\text{C}/\text{W}$
$R_{\theta JA}$	Thermal Resistance, Junction to Ambient	60	60	60	$^{\circ}\text{C}/\text{W}$
P_D	Total Power Dissipation at $T_C = 25^{\circ}\text{C}$	125	125	150	W

Notes
 For information concerning connection diagram and package outline, refer to Section 7.

IRF440-443/IRF840-843

T-39-11

Electrical Characteristics ($T_C = 25^\circ\text{C}$ unless otherwise noted)

Symbol	Characteristic	Min	Max	Unit	Test Conditions	
Off Characteristics						
$V_{(BR)DSS}$	Drain Source Breakdown Voltage ¹			V	$V_{GS} = 0\text{ V}$, $I_D = 250\ \mu\text{A}$	
	IRF440/442/840/842	500				
	IRF441/443/842/843	450				
I_{DSS}	Zero Gate Voltage Drain Current		250	μA	$V_{DS} = \text{Rated } V_{DSS}$, $V_{GS} = 0\text{ V}$	
			1000	μA	$V_{DS} = 0.8 \times \text{Rated } V_{DSS}$, $V_{GS} = 0\text{ V}$, $T_C = 125^\circ\text{C}$	
I_{GSS}	Gate-Body Leakage Current			nA	$V_{GS} = \pm 20\text{ V}$, $V_{DS} = 0\text{ V}$	
			± 100			
	IRF840-843		± 500			
On Characteristics						
$V_{GS(th)}$	Gate Threshold Voltage	2.0	4.0	V	$I_D = 250\ \mu\text{A}$, $V_{DS} = V_{GS}$	
$R_{DS(on)}$	Static Drain-Source On-Resistance ²			Ω	$V_{GS} = 10\text{ V}$, $I_D = 4.0\text{ A}$	
		IRF440/441/840/841		0.85		
		IRF442/443/842/843		1.10		
g_{fs}	Forward Transconductance	4.0		S (Ω)	$V_{DS} = 10\text{ V}$, $I_D = 4.0\text{ A}$	
Dynamic Characteristics						
C_{iss}	Input Capacitance		1600	pF	$V_{DS} = 25\text{ V}$, $V_{GS} = 0\text{ V}$ $f = 1.0\text{ MHz}$	
C_{oss}	Output Capacitance		350	pF		
C_{rss}	Reverse Transfer Capacitance		150	pF		
Switching Characteristics ($T_C = 25^\circ\text{C}$, Figures 9, 10)						
$t_{d(on)}$	Turn-On Delay Time		35	ns	$V_{DD} = 220\text{ V}$, $I_D = 4.0\text{ A}$ $V_{GS} = 10\text{ V}$, $R_{GEN} = 4.7\ \Omega$ $R_{GS} = 4.7\ \Omega$	
t_r	Rise Time		15	ns		
$t_{d(off)}$	Turn-Off Delay Time		90	ns		
t_f	Fall Time		30	ns		
Q_g	Total Gate Charge		60	nC	$V_{GS} = 10\text{ V}$, $I_D = 12\text{ A}$ $V_{DD} = 400\text{ V}$	
Symbol Characteristic Typ Max Unit Test Conditions						
Source-Drain Diode Characteristics						
V_{SD}	Diode Forward Voltage		2.0	V	$I_S = 8.0\text{ A}$; $V_{GS} = 0\text{ V}$	
	IRF440/441/840/841					
	IRF442/443/842/843		1.9	V	$I_S = 7.0\text{ A}$; $V_{GS} = 0\text{ V}$	
t_{rr}	Reverse Recovery Time	700		ns	$I_S = 8.0\text{ A}$; $di_S/dt = 100\text{ A}/\mu\text{S}$	

Notes

- $T_J = +25^\circ\text{C}$ to $+150^\circ\text{C}$
- Pulse test: Pulse width $\leq 80\ \mu\text{s}$, Duty cycle $\leq 1\%$

MTM7N45/7N50

T-39-11

Electrical Characteristics ($T_C = 25^\circ\text{C}$ unless otherwise noted)

Symbol	Characteristic	Min	Max	Unit	Test Conditions
Off Characteristics					
$V_{(BR)DSS}$	Drain Source Breakdown Voltage ¹ MTM7N50 MTM7N45			V	$V_{GS} = 0\text{ V}$, $I_D = 5.0\text{ mA}$
		500			
		450			
I_{DSS}	Zero Gate Voltage Drain Current		0.25	mA	$V_{DS} = 0.85 \times \text{Rated } V_{DSS}$, $V_{GS} = 0\text{ V}$
			2.5	mA	$V_{DS} = 0.85 \times \text{Rated } V_{DSS}$, $V_{GS} = 0\text{ V}$, $T_C = 100^\circ\text{C}$
I_{GSS}	Gate-Body Leakage Current		± 500	nA	$V_{GS} = \pm 20\text{ V}$, $V_{DS} = 0\text{ V}$
On Characteristics					
$V_{GS(th)}$	Gate Threshold Voltage	2.0	4.5	V	$I_D = 1.0\text{ mA}$, $V_{DS} = V_{GS}$
		1.5	4.0	V	$I_D = 1.0\text{ mA}$, $V_{DS} = V_{GS}$, $T_C = 100^\circ\text{C}$
$R_{DS(on)}$	Static Drain-Source On-Resistance ²		0.8	Ω	$V_{GS} = 10\text{ V}$, $I_D = 3.5\text{ A}$
$V_{DS(on)}$	Drain-Source On-Voltage ²		2.8	V	$V_{GS} = 10\text{ V}$, $I_D = 3.5\text{ A}$
			7.0	V	$V_{GS} = 10\text{ V}$, $I_D = 7.0\text{ A}$
			5.6	V	$V_{GS} = 10\text{ V}$, $I_D = 3.5\text{ A}$, $T_C = 100^\circ\text{C}$
g_{fs}	Forward Transconductance	4.0		S (Ω)	$V_{DS} = 10\text{ V}$, $I_D = 4.0\text{ A}$
Dynamic Characteristics					
C_{iss}	Input Capacitance		1800	pF	$V_{DS} = 25\text{ V}$, $V_{GS} = 0\text{ V}$ $f = 1.0\text{ MHz}$
C_{oss}	Output Capacitance		350	pF	
C_{rss}	Reverse Transfer Capacitance		150	pF	
Switching Characteristics ($T_C = 25^\circ\text{C}$, Figures 9, 10)³					
$t_{d(on)}$	Turn-On Delay Time		60	ns	$V_{DD} = 25\text{ V}$, $I_D = 3.5\text{ A}$, $V_{GS} = 10\text{ V}$, $R_{GEN} = 50\ \Omega$, $R_{GS} = 50\ \Omega$
t_r	Rise Time		150	ns	
$t_{d(off)}$	Turn-Off Delay Time		200	ns	
t_f	Fall Time		120	ns	
Q_g	Total Gate Charge		60	nC	$V_{GS} = 10\text{ V}$, $I_D = 12\text{ A}$, $V_{DD} = 400\text{ V}$

Notes

- $T_J = +25^\circ\text{C}$ to $+150^\circ\text{C}$
- Pulse test: Pulse width $\leq 80\ \mu\text{s}$, Duty cycle $\leq 1\%$
- Switching time measurements performed on LEM TR-58 test equipment

IRF440-443/IRF840-843
MTM7N45/7N50

T-39-11

Typical Performance Curves

Figure 1 Output Characteristics

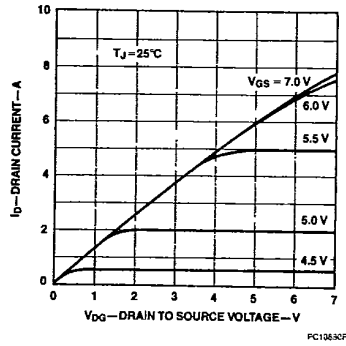

Figure 2 Static Drain to Source Resistance vs Drain Current

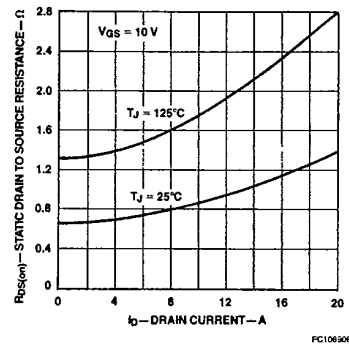

Figure 3 Transfer Characteristics

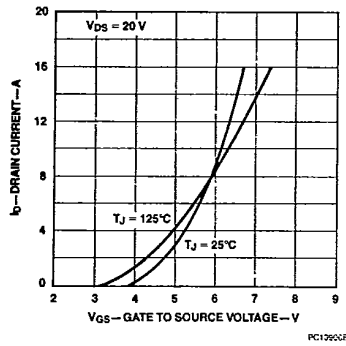

Figure 4 Temperature Variation of Gate to Source Threshold Voltage

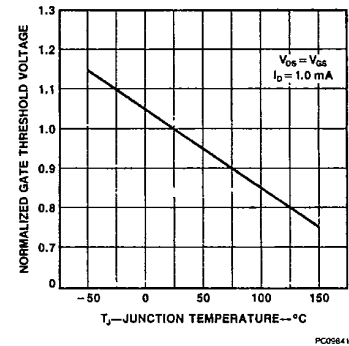

Figure 5 Capacitance vs Drain to Source Voltage

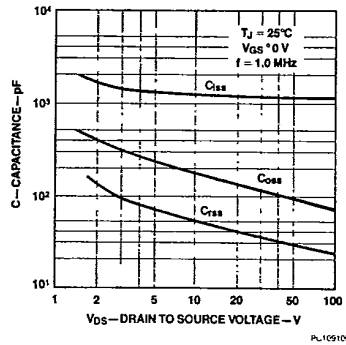
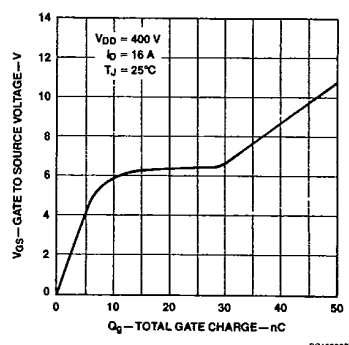

Figure 6 Gate to Source Voltage vs Total Gate Charge



IRF440-443/IRF840-843
MTM7N45/7N50

T-39-11

Typical Performance Curves (Cont.)

Figure 7 Forward Biased Safe Operating Area Curves

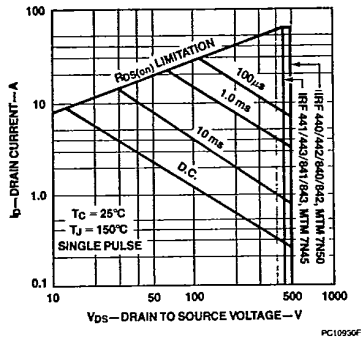
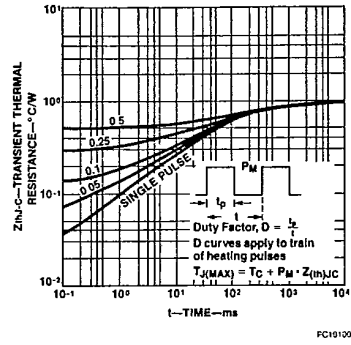

Figure 8 Transient Thermal Resistance vs Time



Typical Electrical Characteristics

Figure 9 Switching Test Circuit

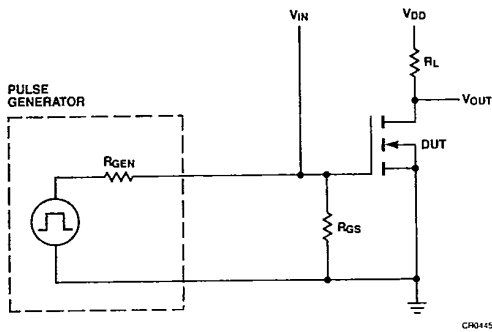

Figure 10 Switching Waveforms

