

IRF350/351/352/353**N-CHANNEL
POWER MOSFETS****FEATURES**

- Low $R_{DS(on)}$
- Improved inductive ruggedness
- Fast switching times
- Rugged polysilicon gate cell structure
- Low input capacitance
- Extended safe operating area
- Improved high temperature reliability
- TO-3 package (Standard)

**PRODUCT SUMMARY**

Part Number	V_{DS}	$R_{DS(on)}$	I_D
IRF250	400V	0.3 Ω	15A
IRF251	350V	0.3 Ω	15A
IRF252	400V	0.4 Ω	13A
IRF253	350V	0.4 Ω	13A

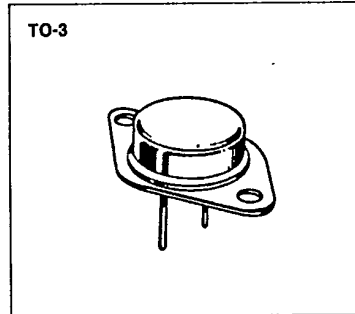
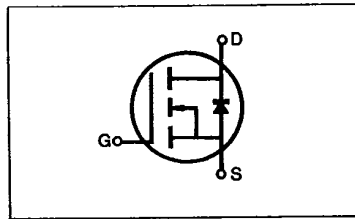

4

MAXIMUM RATINGS

Characteristic	Symbol	IRF350	IRF351	IRF352	IRF353	Unit
Drain-Source Voltage (1)	V_{DS}	400	350	400	350	Vdc
Drain-Gate Voltage ($R_{GS}=1.0M\Omega$) (1)	V_{DGR}	400	350	400	350	Vdc
Gate-Source Voltage	V_{GS}	± 20				Vdc
Continuous Drain Current $T_C=25^\circ C$	I_D	15	15	13	13	Adc
Continuous Drain Current $T_C=100^\circ C$	I_D	9.0	9.0	8.0	8.0	Adc
Drain Current—Pulsed (3)	I_{DM}	60	60	52	52	Adc
Gate Current—Pulsed	I_{GM}	± 1.5				Adc
Total Power Dissipation @ $T_C=25^\circ C$ Derate above $25^\circ C$	P_D	150 1.2				Watts W/ $^\circ C$
Operating and Storage Junction Temperature Range	T_J, T_{stg}	-55 to 150				$^\circ C$
Maximum Lead Temp. for Soldering Purposes, 1/8" from case for 5 seconds	T_L	300				$^\circ C$

- Notes: (1) $T_J=25^\circ C$ to $150^\circ C$
 (2) Pulse test: Pulse width $\leq 300\mu s$, Duty Cycle $\leq 2\%$
 (3) Repetitive rating: Pulse width limited by max. junction temperature

IRF350/351/352/353**N-CHANNEL
POWER MOSFETS****ELECTRICAL CHARACTERISTICS** ($T_C=25^\circ\text{C}$ unless otherwise specified)

Characteristic	Symbol	Type	Min	Typ	Max	Units	Test Conditions
Drain-Source Breakdown Voltage	BV_{DSS}	IRF350 IRF352	400	—	—	V	$V_{GS}=0V$
		IRF351 IRF353	350	—	—	V	$I_D=250\mu A$
Gate Threshold Voltage	$V_{GS(th)}$	ALL	2.0	—	4.0	V	$V_{DS}=V_{GS}$, $I_D=250\mu A$
Gate-Source Leakage Forward	I_{GSS}	ALL	—	—	100	nA	$V_{GS}=20V$
Gate-Source Leakage Reverse	I_{GSS}	ALL	—	—	-100	nA	$V_{GS}=-20V$
Zero Gate Voltage Drain Current	I_{DSS}	ALL	—	—	250	μA	$V_{DS}=\text{Max. Rating}$, $V_{GS}=0V$
		ALL	—	—	1000	μA	$V_{DS}=\text{Max. Rating}\times 0.8$, $V_{GS}=0V$, $T_C=125^\circ\text{C}$
On-State Drain-Source Current (2)	$I_{D(on)}$	IRF350 IRF351	15	—	—	A	$V_{DS}>I_{D(on)}\times R_{DS(on)}$ max., $V_{GS}=10V$
		IRF352 IRF353	13	—	—	A	
Static Drain-Source On-State Resistance (2)	$R_{DS(on)}$	IRF350 IRF351	—	0.25	0.3	Ω	$V_{GS}=10V$, $I_D=8.0A$
		IRF352 IRF353	—	0.3	0.4	Ω	
Forward Transconductance (2)	g_{fs}	ALL	8.0	11	—	S	$V_{DS}>I_{D(on)}\times R_{DS(on)}$ max., $I_D=8.0A$
Input Capacitance	C_{iss}	ALL	—	2630	3000	pF	$V_{GS}=0V$, $V_{DS}=25V$, $f=1.0\text{MHz}$
Output Capacitance	C_{oss}	ALL	—	390	600	pF	
Reverse Transfer Capacitance	C_{ras}	ALL	—	130	200	pF	
Turn-On Delay Time	$t_{d(on)}$	ALL	—	—	35	ns	$V_{DD}=0.5BV_{DSS}$, $I_D=8.0A$, $Z_O=4.7\Omega$ (MOSFET switching times are essentially independent of operating temperature.)
Rise Time	t_r	ALL	—	—	65	ns	
Turn-Off Delay Time	$t_{d(off)}$	ALL	—	—	150	ns	
Fall Time	t_f	ALL	—	—	75	ns	
Total Gate Charge (Gate-Source Plus Gate-Drain)	Q_g	ALL	—	73	120	nC	$V_{GS}=10V$, $I_D=18A$, $V_{DS}=0.8$ Max. Rating (Gate charge is essentially independent of operating temperature.)
Gate-Source Charge	Q_{gs}	ALL	—	14	—	nC	
Gate-Drain ("Miller") Charge	Q_{gd}	ALL	—	59	—	nC	

THERMAL RESISTANCE

Junction-to-Case	R_{thJC}	ALL	—	—	0.83	K/W	
Case-to-Sink	R_{thCS}	ALL	—	0.1	—	K/W	Mounting surface flat, smooth, and greased
Junction-to-Ambient	R_{thJA}	ALL	—	—	30	K/W	Free Air Operation

Notes: (1) $T_J=25^\circ\text{C}$ to 150°C (2) Pulse test: Pulse width $\leq 300\mu\text{s}$, Duty Cycle $\leq 2\%$

(3) Repetitive rating: Pulse width limited by max. junction temperature

IRF350/351/352/353

**N-CHANNEL
POWER MOSFETS**

SOURCE-DRAIN DIODE RATINGS AND CHARACTERISTICS

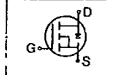
Characteristic	Symbol	Type	Min	Typ	Max	Units	Test Conditions
Continuous Source Current (Body Diode)	I_S	IRF350	—	—	15	A	Modified MOSFET symbol showing the integral reverse P-N junction rectifier 
		IRF351	—	—	13	A	
		IRF352 IRF353	—	—	13	A	
Pulse Source Current (Body Diode) (3)	I_{SM}	IRF350	—	—	60	A	
		IRF351	—	—	52	A	
		IRF352 IRF353	—	—	52	A	
Diode Forward Voltage (2)	V_{SD}	IRF350	—	—	1.6	V	$T_C=25^\circ\text{C}$, $I_S=15\text{A}$, $V_{GS}=0\text{V}$
		IRF351	—	—	1.5	V	$T_C=25^\circ\text{C}$, $I_S=13\text{A}$, $V_{GS}=0\text{V}$
		IRF352 IRF353	—	—	1.5	V	$T_C=25^\circ\text{C}$, $I_S=13\text{A}$, $V_{GS}=0\text{V}$
Reverse Recovery Time	t_{rr}	ALL	—	1000	—	ns	$T_J=150^\circ\text{C}$, $I_F=15\text{A}$, $dI_F/dt=100\text{A}/\mu\text{s}$

Notes: (1) $T_J=25^\circ\text{C}$ to 150°C (2) Pulse test: Pulse width $\leq 300\mu\text{s}$, Duty Cycle $\leq 2\%$
 (3) Repetitive ratio: Pulse width limited by max. junction temperature

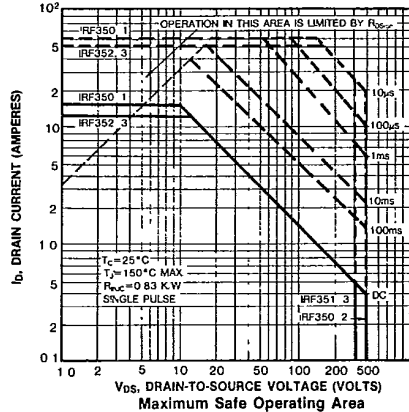
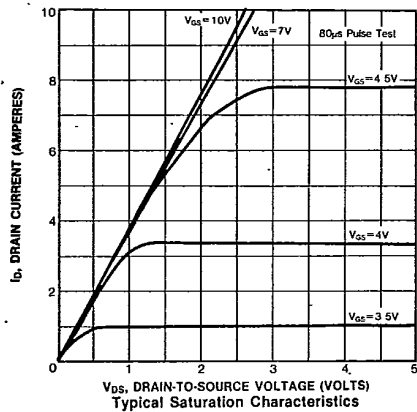
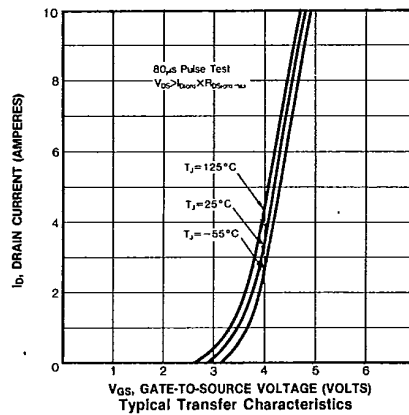
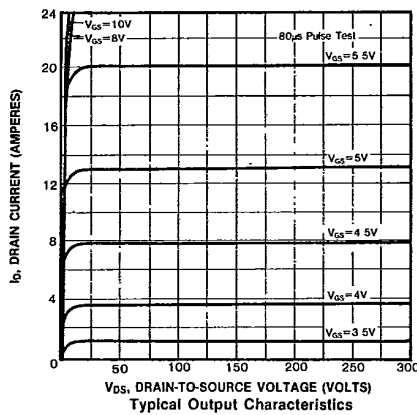

IRF350/351/352/353

N-CHANNEL POWER MOSFETS

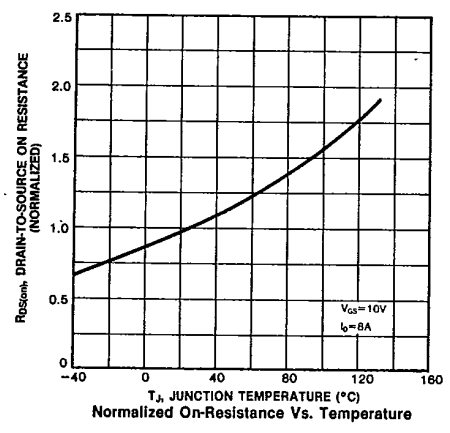
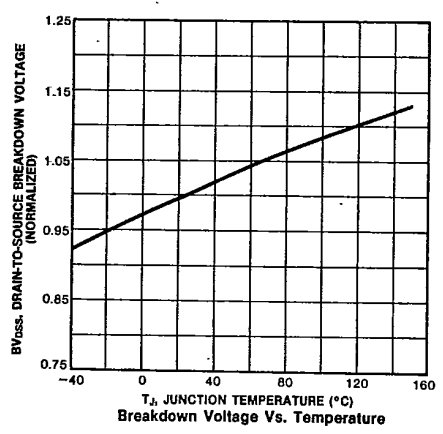
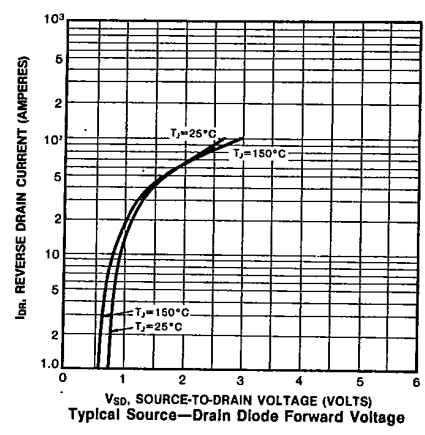
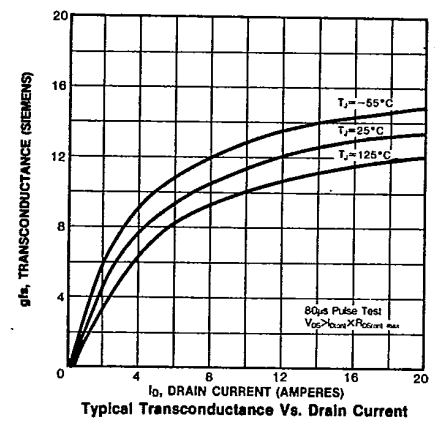
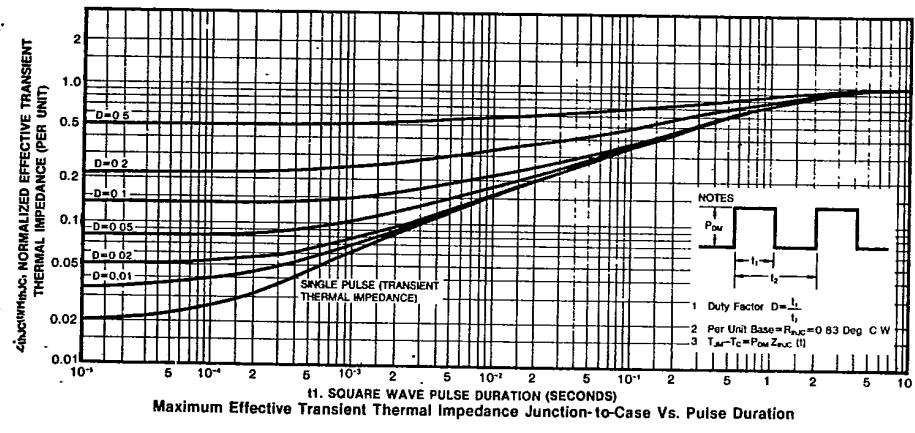

IRF350/351/352/353

**N-CHANNEL
POWER MOSFETS**

