

## Power MOSFET, 40 A

**SOT-227**

PRODUCT SUMMARY	
$V_{DSS}$	500 V
$R_{DS(on)}$ (typical)	0.084 $\Omega$
$I_D$	40 A
Type	Modules - MOSFET
Package	SOT-227

### FEATURES

- Low gate charge  $Q_g$  results in simple drive requirement
- Improved gate, avalanche and dynamic  $dV/dt$  ruggedness
- Fully characterized capacitance and avalanche voltage and current
- Low  $R_{DS(on)}$
- Fully insulated package
- UL pending
- Compliant to RoHS directive 2002/95/EC
- Designed and qualified for industrial level

**RoHS**  
COMPLIANT

### APPLICATIONS

- Switch mode power supply (SMPS)
- Uninterruptible power supply
- High speed power switching
- Hard switched and high frequency circuits

ABSOLUTE MAXIMUM RATINGS				
PARAMETER	SYMBOL	TEST CONDITIONS	MAX.	UNITS
Continuous drain current, $V_{GS}$ at 10 V	$I_D$	$T_C = 25\text{ }^\circ\text{C}$	40	A
		$T_C = 100\text{ }^\circ\text{C}$	26	
Pulsed drain current	$I_{DM}^{(1)}$		160	
Power dissipation	$P_D$	$T_C = 25\text{ }^\circ\text{C}$	430	W
Linear derating factor			3.45	W/ $^\circ\text{C}$
Gate to source voltage	$V_{GS}$		$\pm 30$	V
Peak diode recovery $dV/dt$	$dV/dt^{(2)}$		9.0	V/ns
Operating junction and storage temperature range	$T_J, T_{Stg}$		- 55 to + 150	$^\circ\text{C}$

#### Notes

- (1) Repetitive rating; pulse width limited by maximum junction temperature (see fig. 11)  
 (2)  $I_{SD} \leq 40\text{ A}$ ,  $dI/dt \leq 150\text{ A}/\mu\text{s}$ ,  $V_{DD} \leq V_{(BR)DSS}$ ,  $T_J \leq 150\text{ }^\circ\text{C}$

AVALANCHE CHARACTERISTICS				
PARAMETER	SYMBOL	TYP.	MAX.	UNITS
Single pulse avalanche energy	$E_{AS}^{(1)}$	-	1240	mJ
Avalanche current	$I_{AR}^{(2)}$	-	40	A
Repetitive avalanche energy	$E_{AR}^{(2)}$	-	43	mJ

#### Notes

- (1) Starting  $T_J = 25\text{ }^\circ\text{C}$ ,  $L = 1.55\text{ mH}$ ,  $R_G = 25\text{ }^\circ\Omega$ ,  $I_{AS} = 40\text{ A}$ ,  $dV/dt = 5.5\text{ V/ns}$  (see fig. 12a)  
 (2) Repetitive rating; pulse width limited by maximum junction temperature (see fig. 11)



THERMAL RESISTANCE				
PARAMETER	SYMBOL	TYP.	MAX.	UNITS
Junction to case	$R_{thJC}$	-	0.29	°C/W
Case to sink, flat, greased surface	$R_{thCS}$	0.05	-	

STATIC CHARACTERISTICS ( $T_J = 25\text{ °C}$ unless otherwise noted)						
PARAMETER	SYMBOL	TEST CONDITIONS	MIN.	TYP.	MAX.	UNITS
Drain to source breakdown voltage	$V_{(BR)DSS}$	$V_{GS} = 0\text{ V}, I_D = 250\text{ }\mu\text{A}$	500	-	-	V
Breakdown voltage temperature coefficient	$\Delta V_{(BR)DSS}/\Delta T_J$	Reference to $25\text{ °C}, I_D = 1\text{ mA}$	-	0.60	-	V/°C
Static drain to source on-resistance	$R_{DS(on)}^{(1)}$	$V_{GS} = 10\text{ V}, I_D = 24\text{ A}$	-	0.084	0.10	$\Omega$
Gate threshold voltage	$V_{GS(th)}$	$V_{DS} = V_{GS}, I_D = 250\text{ }\mu\text{A}$	3.0	-	5.0	V
Drain to source leakage current	$I_{DSS}$	$V_{DS} = 500\text{ V}, V_{GS} = 0\text{ V}$ $V_{DS} = 400\text{ V}, V_{GS} = 0\text{ V}, T_J = 125\text{ °C}$	-	-	50 250	$\mu\text{A}$
Gate to source forward leakage	$I_{GSS}$	$V_{GS} = 30\text{ V}$	-	-	250	nA
Gate to source reverse leakage		$V_{GS} = -30\text{ V}$	-	-	-250	

**Note**

(1) Pulse width  $\leq 300\text{ }\mu\text{s}$ ; duty cycle  $\leq 2\%$

DYNAMIC CHARACTERISTICS ( $T_J = 25\text{ °C}$ unless otherwise noted)							
PARAMETER	SYMBOL	TEST CONDITIONS	MIN.	TYP.	MAX.	UNITS	
Forward transconductance	$g_{fs}$	$V_{DS} = 50\text{ V}, I_D = 28\text{ A}$	23	-	-	S	
Total gate charge	$Q_g^{(1)}$	$I_D = 40\text{ A}$ $V_{DS} = 400\text{ V}$ $V_{GS} = 10\text{ V}$ ; see fig. 6 and 13	-	-	270	nC	
Gate to source charge	$Q_{gs}^{(1)}$		-	-	84		
Gate to drain ("Miller") charge	$Q_{gd}^{(1)}$		-	-	130		
Turn-on delay time	$t_{d(on)}^{(1)}$	$V_{DD} = 250\text{ V}$ $I_D = 40\text{ A}$ $R_g = 1.0\text{ }\Omega$ $V_{GS} = 10\text{ V}$ , see fig. 10	-	25	-	ns	
Rise time	$t_r^{(1)}$		-	140	-		
Turn-off delay time	$t_{d(off)}^{(1)}$		-	55	-		
Fall time	$t_f^{(1)}$		-	74	-		
Input capacitance	$C_{iss}$	$V_{GS} = 0\text{ V}$ $V_{DS} = 25\text{ V}$ $f = 1.0\text{ MHz}$ , see fig. 5	-	8310	-	pF	
Output capacitance	$C_{oss}$		-	960	-		
Reverse transfer capacitance	$C_{rss}$		-	120	-		
Output capacitance	$C_{oss}$		$V_{GS} = 0\text{ V}, V_{DS} = 1.0\text{ V}, f = 1.0\text{ MHz}$	-	10 170		-
			$V_{GS} = 0\text{ V}, V_{DS} = 480\text{ V}, f = 1.0\text{ MHz}$	-	240		-
Effective output capacitance	$C_{oss\text{ eff.}}^{(2)}$	$V_{GS} = 0\text{ V}, V_{DS} = 0\text{ V to }480\text{ V}$	-	440	-		

**Notes**

(1) Pulse width  $\leq 300\text{ }\mu\text{s}$ ; duty cycle  $\leq 2\%$

(2)  $C_{oss\text{ eff.}}$  is a fixed capacitance that gives the same charging time as  $C_{oss}$  while  $V_{DS}$  is rising from 0 to 80 %  $V_{DSS}$

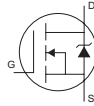
DIODE CHARACTERISTICS						
PARAMETER	SYMBOL	TEST CONDITIONS	MIN.	TYP.	MAX.	UNITS
Continuous source current (body diode)	$I_S$	MOSFET symbol showing the integral reverse p-n junction diode 	-	-	40	A
Pulsed source current (body diode)	$I_{SM}^{(1)}$		-	-	160	
Diode forward voltage	$V_{SD}^{(2)}$	$T_J = 25\text{ }^\circ\text{C}$ , $I_S = 40\text{ A}$ , $V_{GS} = 0\text{ V}$	-	-	1	V
Reverse recovery time	$t_{rr}^{(2)}$	$T_J = 25\text{ }^\circ\text{C}$ , $I_F = 47\text{ A}$ ; $dI/dt = 100\text{ A}/\mu\text{s}$	-	620	940	ns
Reverse recovery charge	$Q_{rr}$		-	14	21	$\mu\text{C}$
Reverse recovery current	$I_{RRM}$	$T_J = 25\text{ }^\circ\text{C}$	-	38	-	A
Forward turn-on time	$t_{on}$	Intrinsic turn-on time is negligible (turn-on is dominated by $L_S + L_D$ )				

Notes

(1) Repetitive rating; pulse width limited by maximum junction temperature (see fig. 11)

(2) Pulse width  $\leq 300\text{ }\mu\text{s}$ ; duty cycle  $\leq 2\%$

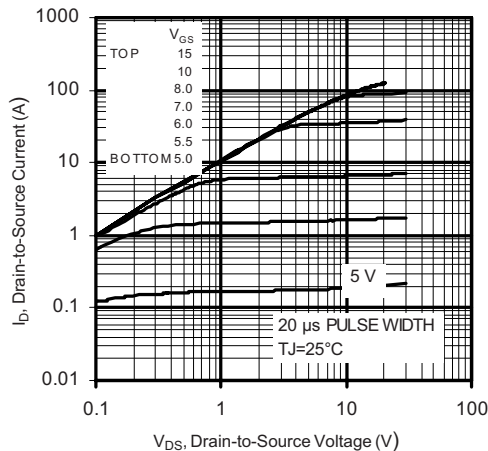

Fig. 1 - Typical Output Characteristics

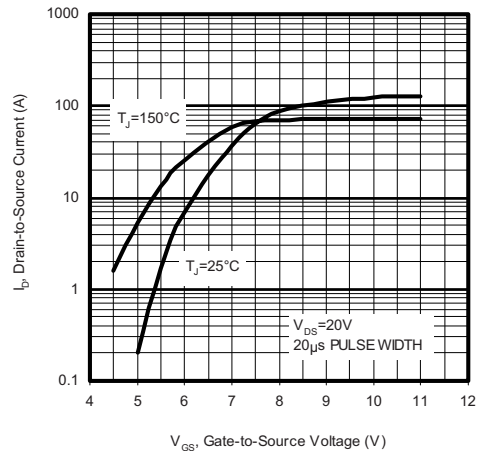

Fig. 3 - Typical Transfer Characteristics

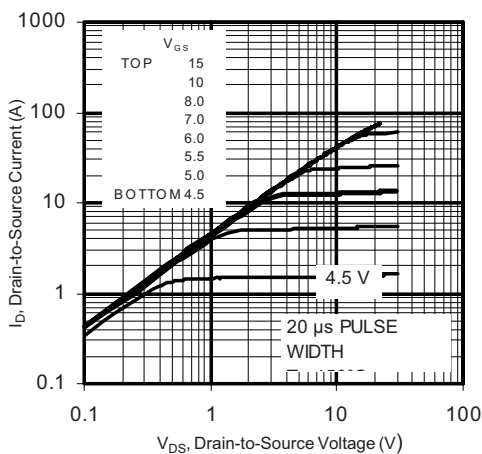

Fig. 2 - Typical Output Characteristics

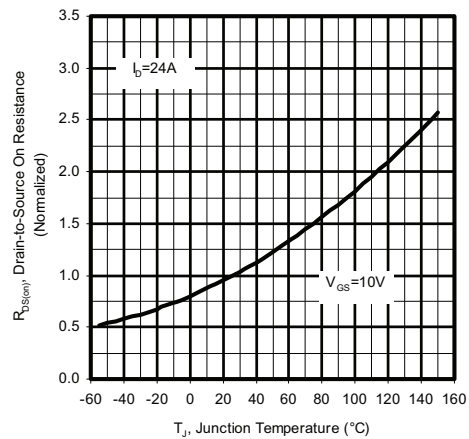

Fig. 4 - Normalized On-Resistance vs. Temperature

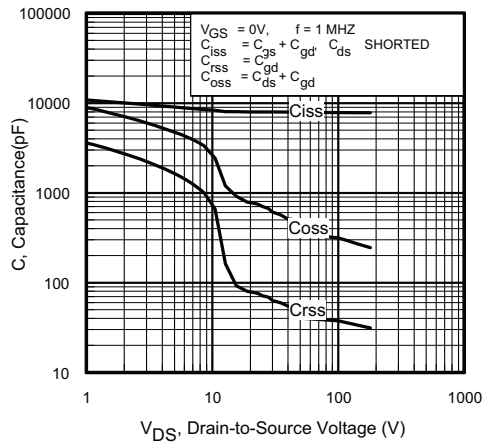

Fig. 5 - Typical Capacitance vs. Drain to Source Voltage

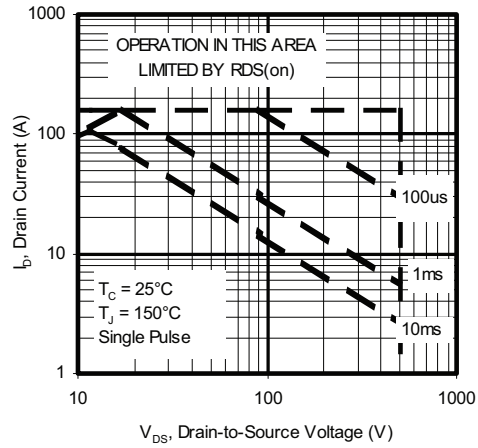

Fig. 8 - Maximum Safe Operating Area

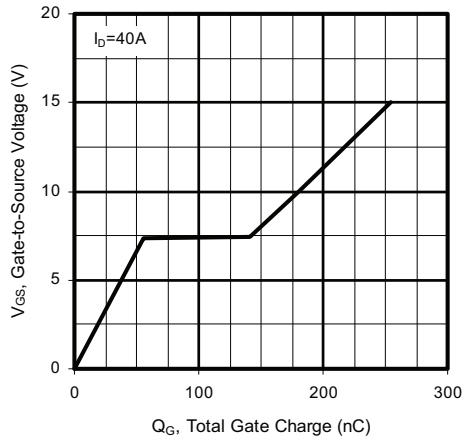

Fig. 6 - Typical Gate Charge vs. Gate to Source Voltage

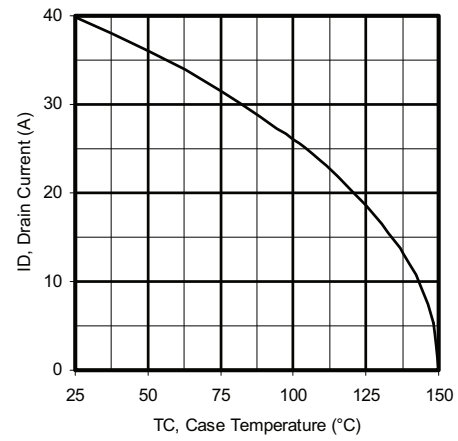

Fig. 9 - Maximum Drain Current vs. Case Temperature

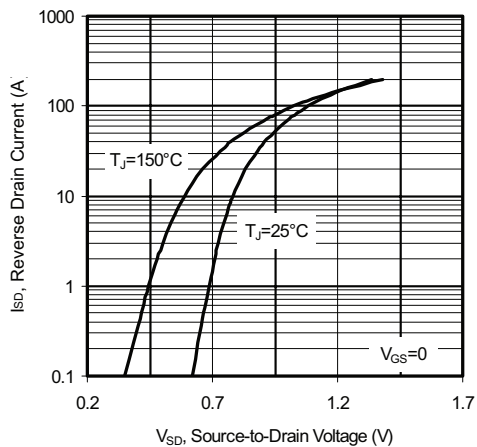

Fig. 7 - Typical Source Drain Diode Forward Voltage

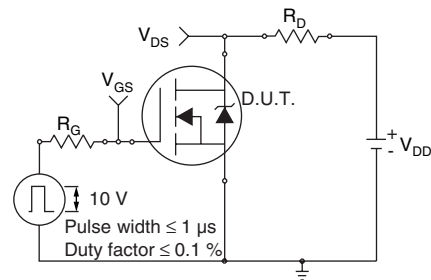

Fig. 10a - Switching Time Test Circuit

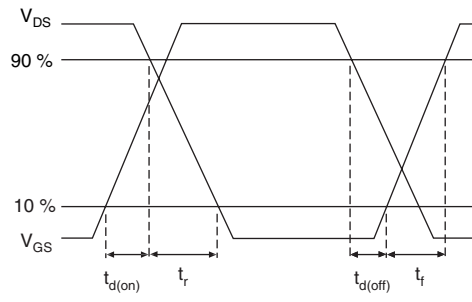

Fig. 10b - Switching Time Waveforms

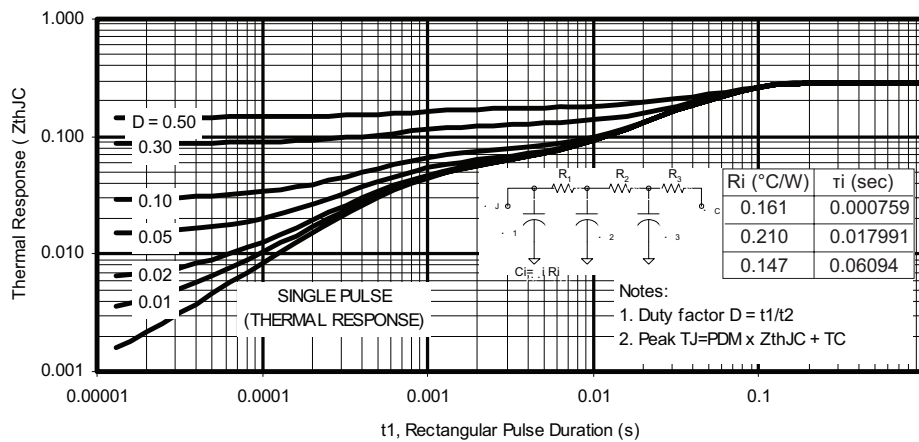

Fig. 11 - Maximum Effective Transient Thermal Impedance, Junction to Case

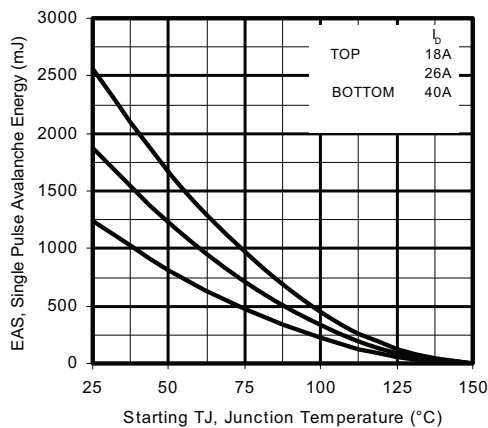

Fig. 12a - Maximum Avalanche Energy vs. Drain Current

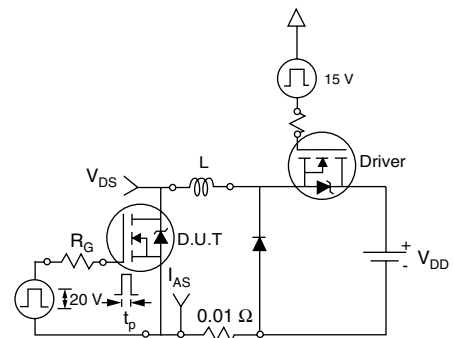

Fig. 12b - Unclamped Inductive Test Circuit

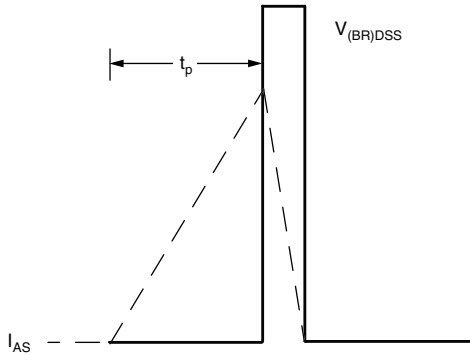

Fig. 12c - Unclamped Inductive Waveforms

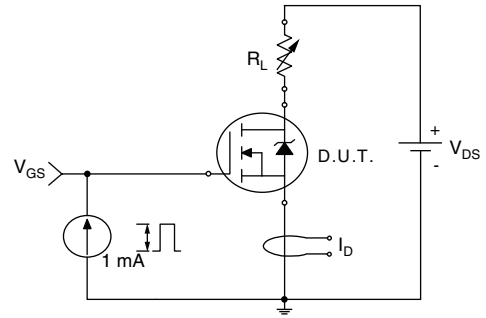

Fig. 13a - Gate Charge Test Circuit

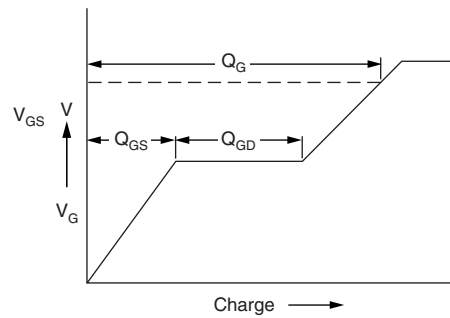

Fig. 13b - Basic Gate Charge Waveform

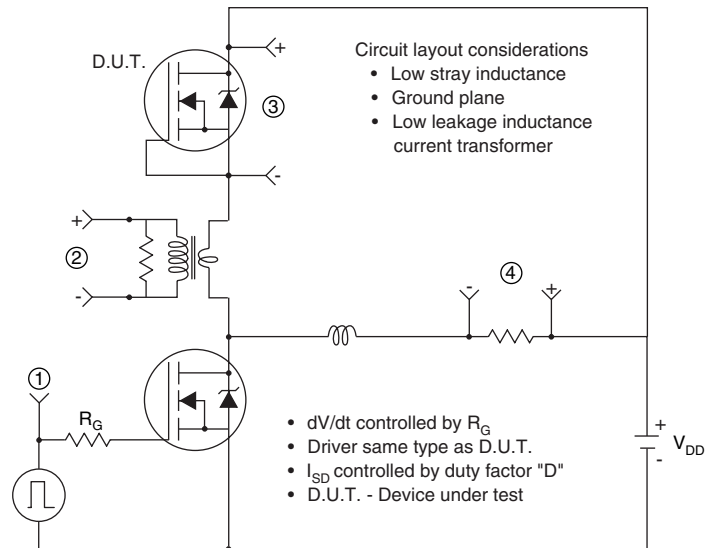
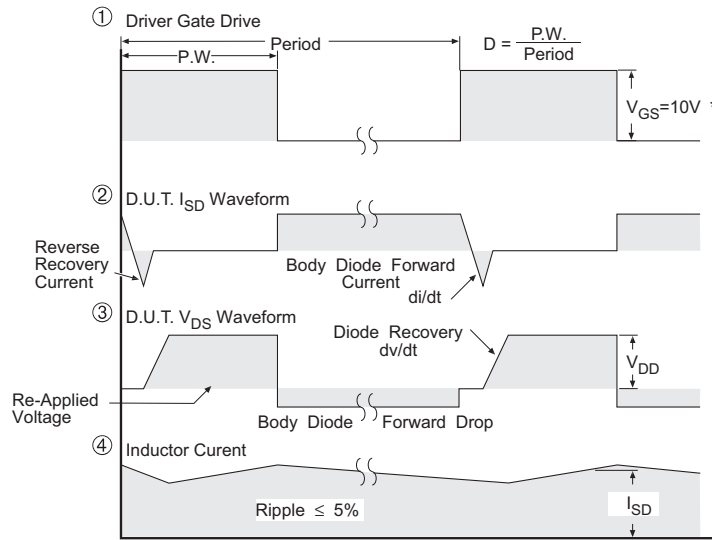

Fig. 13c - Peak Diode Recovery  $dV/dt$  Test Circuit



\*  $V_{GS} = 5V$  for Logic Level Devices

Fig. 14 - For N-Channel Power MOSFETs

**ORDERING INFORMATION TABLE**

Device code	<b>F</b>	<b>C</b>	<b>40</b>	<b>S</b>	<b>A</b>	<b>50</b>	<b>FK</b>	<b>P</b>
	①	②	③	④	⑤	⑥	⑦	⑧

- 1** - Power MOSFET
- 2** - Generation 6.2/6.3 MOSFET silicon DBC construction
- 3** - Current rating (40 = 40 A)
- 4** - Single switch (see Circuit Configuration table)
- 5** - SOT-227
- 6** - Voltage rating (50 = 500 V)
- 7** - MOSFET K speed
- 8** -
  - None = Standard production
  - P = Lead (Pb)-free

# FC40SA50FKP

Vishay Semiconductors

Power MOSFET, 40 A



CIRCUIT CONFIGURATION		
CIRCUIT	CIRCUIT CONFIGURATION CODE	CIRCUIT DRAWING
Single switch no diode	S	

LINKS TO RELATED DOCUMENTS	
Dimensions	<a href="http://www.vishay.com/doc?95036">www.vishay.com/doc?95036</a>
Packaging information	<a href="http://www.vishay.com/doc?95037">www.vishay.com/doc?95037</a>



## Disclaimer

All product specifications and data are subject to change without notice.

Vishay Intertechnology, Inc., its affiliates, agents, and employees, and all persons acting on its or their behalf (collectively, "Vishay"), disclaim any and all liability for any errors, inaccuracies or incompleteness contained herein or in any other disclosure relating to any product.

Vishay disclaims any and all liability arising out of the use or application of any product described herein or of any information provided herein to the maximum extent permitted by law. The product specifications do not expand or otherwise modify Vishay's terms and conditions of purchase, including but not limited to the warranty expressed therein, which apply to these products.

No license, express or implied, by estoppel or otherwise, to any intellectual property rights is granted by this document or by any conduct of Vishay.

The products shown herein are not designed for use in medical, life-saving, or life-sustaining applications unless otherwise expressly indicated. Customers using or selling Vishay products not expressly indicated for use in such applications do so entirely at their own risk and agree to fully indemnify Vishay for any damages arising or resulting from such use or sale. Please contact authorized Vishay personnel to obtain written terms and conditions regarding products designed for such applications.

Product names and markings noted herein may be trademarks of their respective owners.