

## 30V N-Channel NexFET™ Power MOSFETs

Check for Samples: **CSD17559Q5**

### FEATURES

- Extremely Low Resistance
- Ultralow  $Q_g$  and  $Q_{gd}$
- Low Thermal Resistance
- Avalanche Rated
- Pb Free Terminal Plating
- RoHS Compliant
- Halogen Free
- SON 5-mm x 6-mm Plastic Package

### APPLICATIONS

- Point-of-Load Synchronous Buck in Networking, Telecom, and Computing Systems
- Synchronous Rectification
- Active ORing and Hotswap Applications

### DESCRIPTION

The NexFET™ power MOSFET has been designed to minimize losses in synchronous rectification and other power conversion applications.

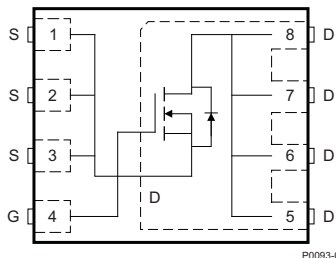
**Top View**

P0093-01

### PRODUCT SUMMARY

$T_A = 25^\circ\text{C}$ unless otherwise stated		TYPICAL VALUE		UNIT
$V_{DS}$	Drain to Source Voltage	30		V
$Q_g$	Gate Charge Total (4.5V)	39		nC
$Q_{gd}$	Gate Charge Gate to Drain	9.3		nC
$R_{DS(on)}$	Drain to Source On Resistance	$V_{GS} = 4.5\text{V}$	1.15	m $\Omega$
		$V_{GS} = 10\text{V}$	0.95	m $\Omega$
$V_{GS(th)}$	Threshold Voltage	1.4		V

### ORDERING INFORMATION

Device	Package	Media	Qty	Ship
CSD17559Q5	SON 5-mm x 6-mm Plastic Package	13-Inch Reel	2500	Tape and Reel

### ABSOLUTE MAXIMUM RATINGS

$T_A = 25^\circ\text{C}$ unless otherwise stated		VALUE	UNIT
$V_{DS}$	Drain to Source Voltage	30	V
$V_{GS}$	Gate to Source Voltage	$\pm 20$	V
$I_D$	Continuous Drain Current (Package limited), $T_C = 25^\circ\text{C}$	100	A
	Continuous Drain Current (Silicon limited), $T_C = 25^\circ\text{C}$	257	
	Continuous Drain Current <sup>(1)</sup>	40	
$I_{DM}$	Pulsed Drain Current, $T_A = 25^\circ\text{C}$ <sup>(1)(2)</sup>	250	A
$P_D$	Power Dissipation <sup>(1)</sup>	3.2	W
$T_J$ , $T_{STG}$	Operating Junction and Storage Temperature Range	-55 to 150	$^\circ\text{C}$
$E_{AS}$	Avalanche Energy, single pulse $I_D = 104\text{A}$ , $L = 0.1\text{mH}$ , $R_G = 25\Omega$	541	mJ

(1) Typical  $R_{\theta JA} = 40^\circ\text{C}/\text{W}$  on 1-inch<sup>2</sup> (6.45-cm<sup>2</sup>), 2-oz. (0.071-mm thick) Cu pad on a 0.06-inch (1.52-mm) thick FR4 PCB.

(2) Pulse duration  $\leq 300\mu\text{s}$ , duty cycle  $\leq 2\%$

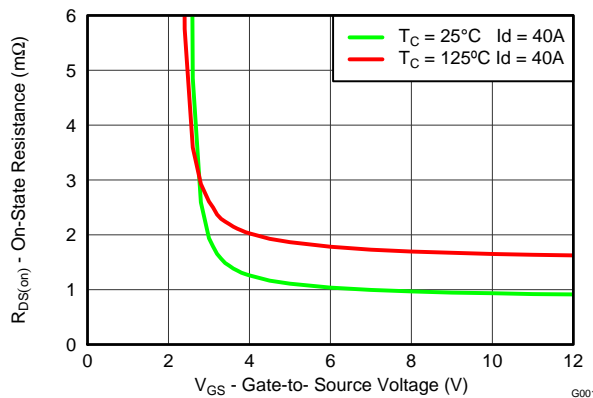
 **$R_{DS(on)}$  vs  $V_{GS}$** 

G001

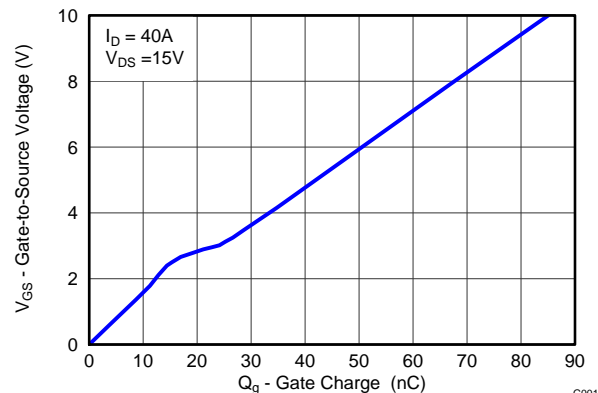
**GATE CHARGE**

G001



Please be aware that an important notice concerning availability, standard warranty, and use in critical applications of Texas Instruments semiconductor products and disclaimers thereto appears at the end of this data sheet.

NexFET is a trademark of Texas Instruments.

PRODUCTION DATA information is current as of publication date. Products conform to specifications per the terms of the Texas Instruments standard warranty. Production processing does not necessarily include testing of all parameters.

Copyright © 2012, Texas Instruments Incorporated



These devices have limited built-in ESD protection. The leads should be shorted together or the device placed in conductive foam during storage or handling to prevent electrostatic damage to the MOS gates.

## ELECTRICAL CHARACTERISTICS

( $T_A = 25^\circ\text{C}$  unless otherwise stated)

PARAMETER		TEST CONDITIONS	MIN	TYP	MAX	UNIT
<b>Static Characteristics</b>						
$BV_{DSS}$	Drain to Source Voltage	$V_{GS} = 0V, I_{DS} = 250\mu A$	30			V
$I_{DSS}$	Drain to Source Leakage Current	$V_{GS} = 0V, V_{DS} = 24V$			1	$\mu A$
$I_{GSS}$	Gate to Source Leakage Current	$V_{DS} = 0V, V_{GS} = 20V$			100	nA
$V_{GS(th)}$	Gate to Source Threshold Voltage	$V_{DS} = V_{GS}, I_{DS} = 250\mu A$	1.2	1.4	1.7	V
$R_{DS(on)}$	Drain to Source On Resistance	$V_{GS} = 4.5V, I_{DS} = 40A$		1.15	1.5	m $\Omega$
		$V_{GS} = 10V, I_{DS} = 40A$		0.95	1.15	m $\Omega$
$g_{fs}$	Transconductance	$V_{DS} = 15V, I_{DS} = 40A$		235		S
<b>Dynamic Characteristics</b>						
$C_{iss}$	Input Capacitance	$V_{GS} = 0V, V_{DS} = 15V,$ $f = 1MHz$		7070	9200	pF
$C_{oss}$	Output Capacitance			1780	2314	pF
$C_{riss}$	Reverse Transfer Capacitance			87	113	pF
$R_G$	Series Gate Resistance			1.2	2.4	$\Omega$
$Q_g$	Gate Charge Total (4.5V)	$V_{DS} = 15V, I_{DS} = 40A$		39	51	nC
$Q_{gd}$	Gate Charge Gate to Drain			9.3		nC
$Q_{gs}$	Gate Charge Gate to Source			14.4		nC
$Q_{g(th)}$	Gate Charge at $V_{th}$			8.3		nC
$Q_{oss}$	Output Charge	$V_{DS} = 15V, V_{GS} = 0V$		50		nC
$t_{d(on)}$	Turn On Delay Time	$V_{DS} = 15V, V_{GS} = 4.5V,$ $I_{DS} = 40A, R_G = 2\Omega$		20		ns
$t_r$	Rise Time			41		ns
$t_{d(off)}$	Turn Off Delay Time			32		ns
$t_f$	Fall Time			14		ns
<b>Diode Characteristics</b>						
$V_{SD}$	Diode Forward Voltage	$I_{SD} = 40A, V_{GS} = 0V$		0.8	1	V
$Q_{rr}$	Reverse Recovery Charge	$V_{DD} = 15V, I_F = 40A, di/dt = 300A/\mu s$		80		nC
$t_{rr}$	Reverse Recovery Time			37		ns

## THERMAL CHARACTERISTICS

( $T_A = 25^\circ\text{C}$  unless otherwise stated)

PARAMETER		MIN	TYP	MAX	UNIT
$R_{\theta JC}$	Thermal Resistance Junction to Case <sup>(1)</sup>			1.2	$^\circ\text{C}/W$
$R_{\theta JA}$	Thermal Resistance Junction to Ambient <sup>(1)(2)</sup>			50	$^\circ\text{C}/W$

- (1)  $R_{\theta JC}$  is determined with the device mounted on a 1-inch<sup>2</sup> (6.45-cm<sup>2</sup>), 2-oz. (0.071-mm thick) Cu pad on a 1.5-inch x 1.5-inch (3.81-cm x 3.81-cm), 0.06-inch (1.52-mm) thick FR4 PCB.  $R_{\theta JC}$  is specified by design, whereas  $R_{\theta JA}$  is determined by the user's board design.
- (2) Device mounted on FR4 material with 1-inch<sup>2</sup> (6.45-cm<sup>2</sup>), 2-oz. (0.071-mm thick) Cu.

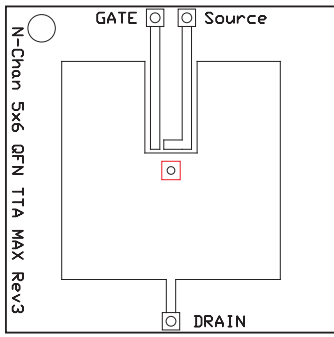

M0137-01

Max  $R_{\theta JA} = 50^{\circ}\text{C/W}$   
when mounted on  
1 inch<sup>2</sup> (6.45 cm<sup>2</sup>) of 2-  
oz. (0.071-mm thick)  
Cu.

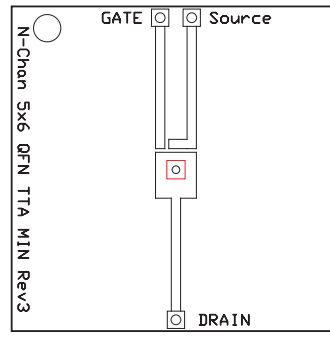

M0137-02

Max  $R_{\theta JA} = 125^{\circ}\text{C/W}$   
when mounted on a  
minimum pad area of  
2-oz. (0.071-mm thick)  
Cu.

### TYPICAL MOSFET CHARACTERISTICS

( $T_A = 25^{\circ}\text{C}$  unless otherwise stated)

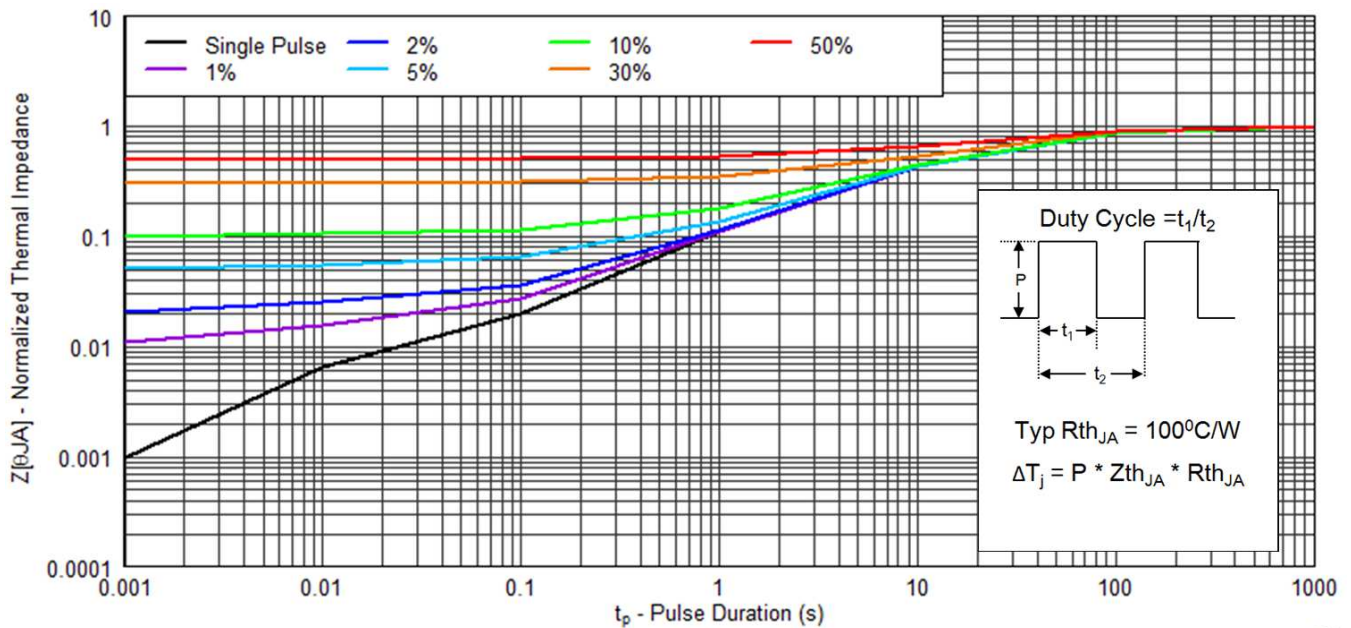
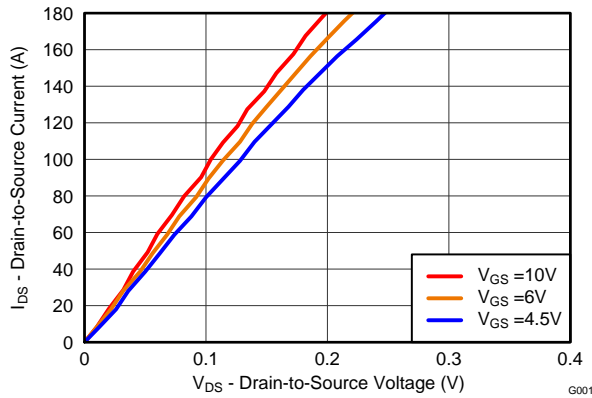

Figure 1. Transient Thermal Impedance

**TYPICAL MOSFET CHARACTERISTICS (continued)**

( $T_A = 25^\circ\text{C}$  unless otherwise stated)



**Figure 2. Saturation Characteristics**

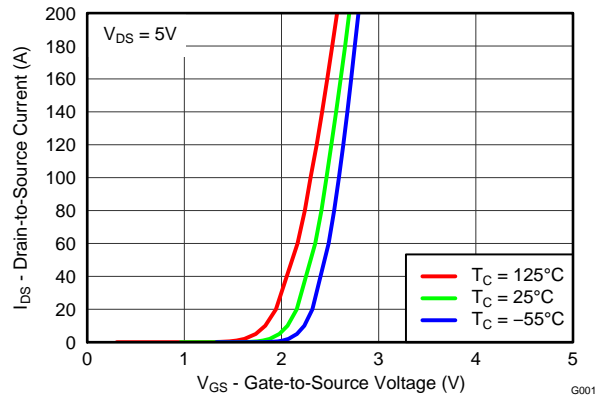

**Figure 3. Transfer Characteristics**

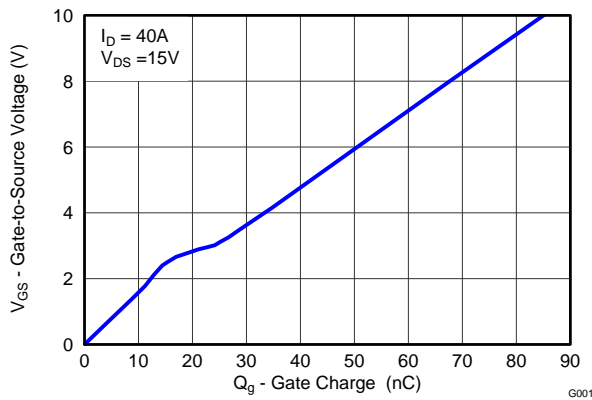

**Figure 4. Gate Charge**

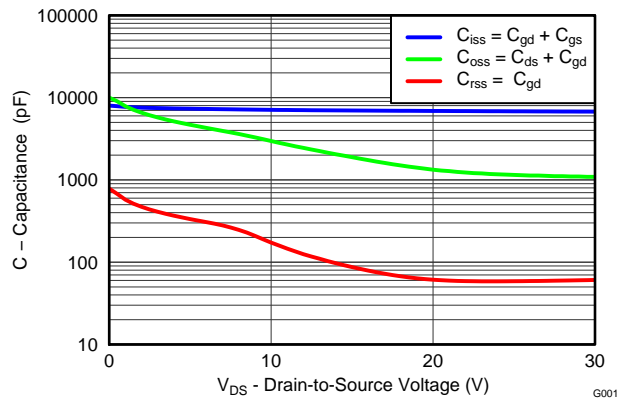

**Figure 5. Capacitance**

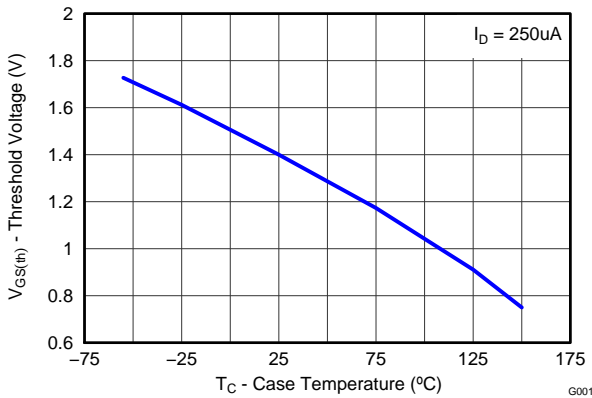

**Figure 6. Threshold Voltage vs. Temperature**

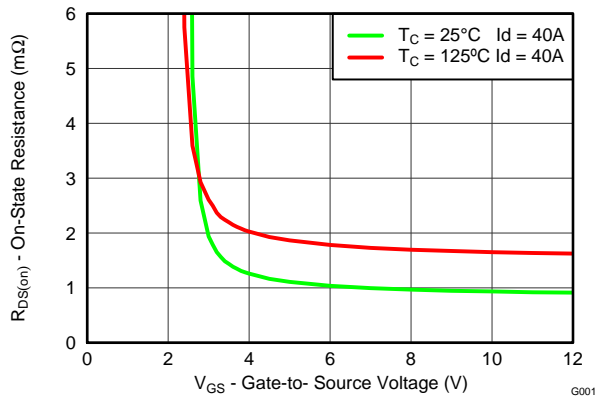

**Figure 7. On-State Resistance vs. Gate-to-Source Voltage**

TYPICAL MOSFET CHARACTERISTICS (continued)

( $T_A = 25^\circ\text{C}$  unless otherwise stated)

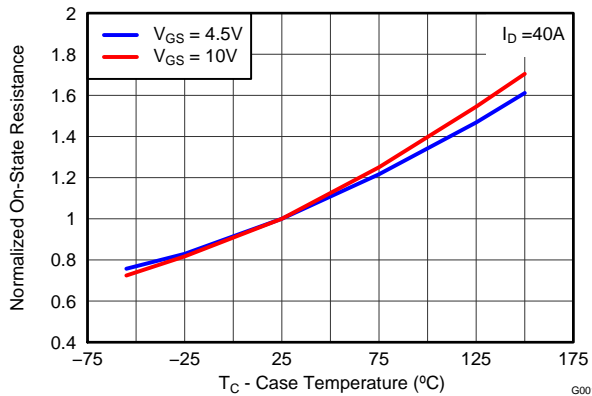

Figure 8. Normalized On-State Resistance vs. Temperature

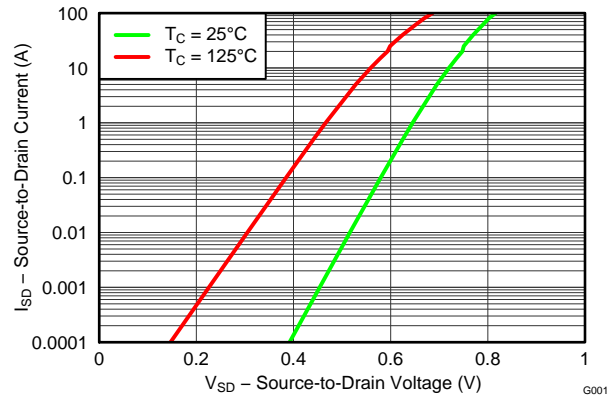

Figure 9. Typical Diode Forward Voltage

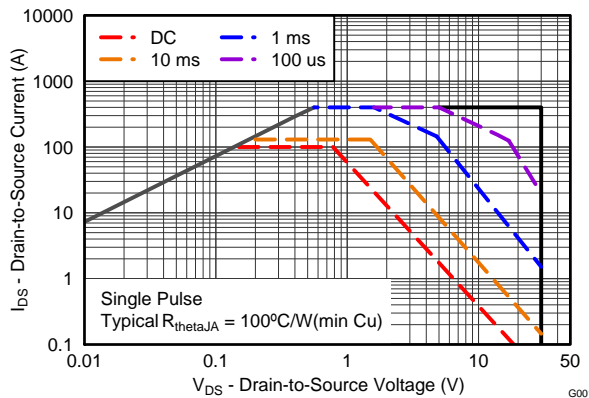

Figure 10. Safety Operating Area  $T_C = 25^\circ\text{C}$

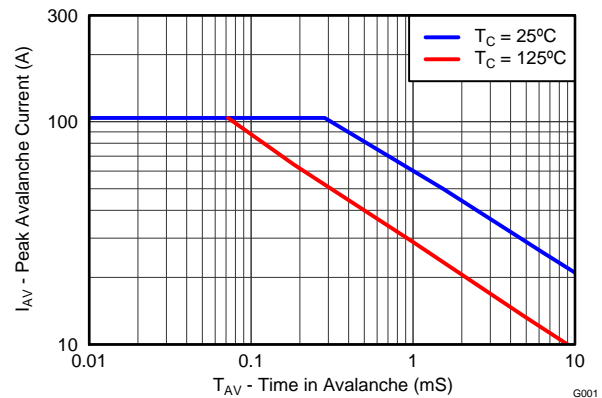

Figure 11. Single Pulse Unclamped Inductive Switching

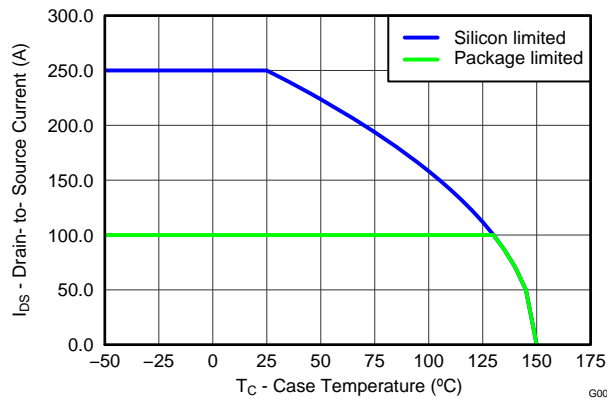
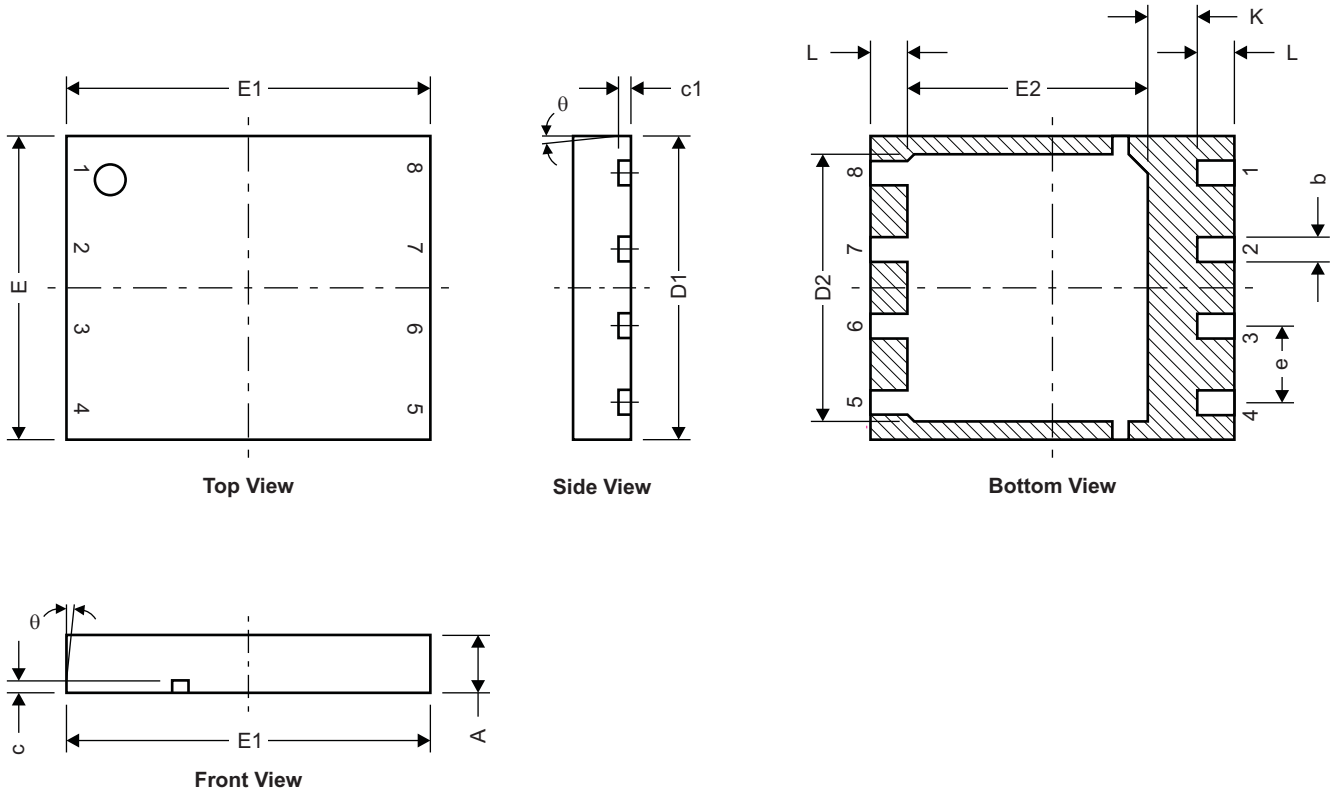

Figure 12. Maximum Drain Current vs. Temperature

**MECHANICAL DATA**

**Q5 Package Dimensions**



M0140-01

DIM	MILLIMETERS		INCHES	
	MIN	MAX	MIN	MAX
A	0.950	1.050	0.037	0.039
b	0.360	0.460	0.014	0.018
c	0.150	0.250	0.006	0.010
c1	0.150	0.250	0.006	0.010
D1	4.900	5.100	0.193	0.201
D2	4.320	4.520	0.170	0.178
E	4.900	5.100	0.193	0.201
E1	5.900	6.100	0.232	0.240
E2	3.920	4.12	0.154	0.162
e	1.27 TYP		0.050	
K	0.760		0.030	
L	0.510	0.710	0.020	0.028
$\theta$	0.00			

Figure 13. Recommended PCB Pattern

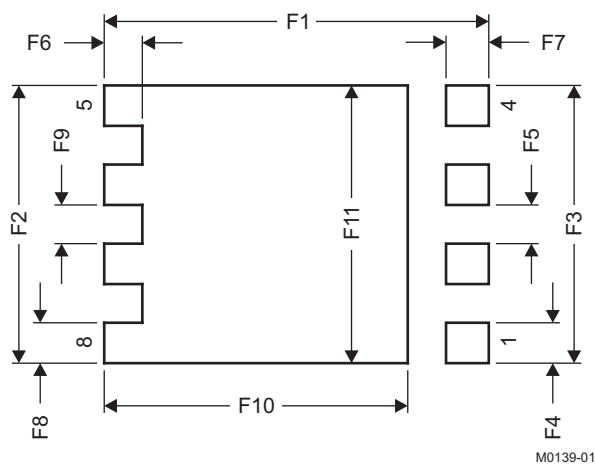

DIM	MILLIMETERS		INCHES	
	MIN	MAX	MIN	MAX
F1	6.205	6.305	0.244	0.248
F2	4.460	4.560	0.176	0.180
F3	4.460	4.560	0.176	0.180
F4	0.650	0.700	0.026	0.028
F5	0.620	0.670	0.024	0.026
F6	0.630	0.680	0.025	0.027
F7	0.700	0.800	0.028	0.031
F8	0.650	0.700	0.026	0.028
F9	0.620	0.670	0.024	0.026
F10	4.900	5.000	0.193	0.197
F11	4.460	4.560	0.176	0.180

Q5 Tape and Reel Information

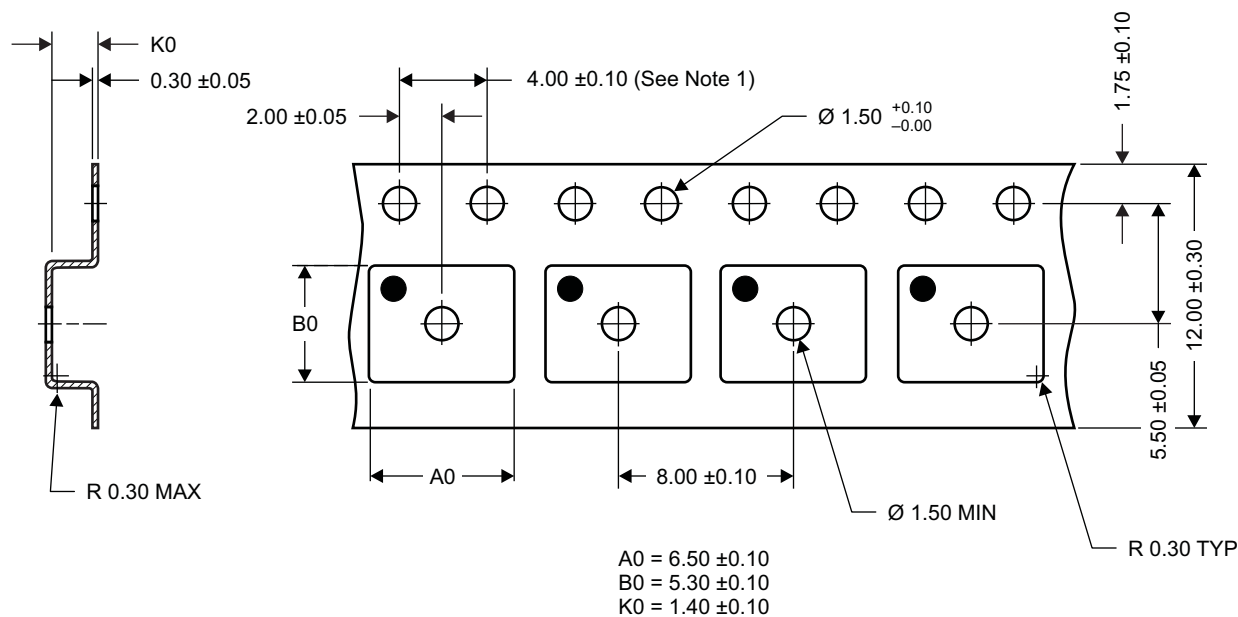

M0138-01

Notes:

1. 10-sprocket hole-pitch cumulative tolerance  $\pm 0.2$
2. Camber not to exceed 1mm in 100mm, noncumulative over 250mm
3. Material: black static-dissipative polystyrene
4. All dimensions are in mm, unless otherwise specified.
5. Thickness:  $0.30 \pm 0.05$ mm
6. MSL1 260°C (IR and convection) PbF reflow compatible

## TAPE AND REEL INFORMATION



### QUADRANT ASSIGNMENTS FOR PIN 1 ORIENTATION IN TAPE



\*All dimensions are nominal

Device	Package Type	Package Drawing	Pins	SPQ	Reel Diameter (mm)	Reel Width W1 (mm)	A0 (mm)	B0 (mm)	K0 (mm)	P1 (mm)	W (mm)	Pin1 Quadrant
CSD17559Q5	SON	DQH	8	2500	330.0	12.8	6.5	5.3	1.4	8.0	12.0	Q1



**TAPE AND REEL BOX DIMENSIONS**



\*All dimensions are nominal

Device	Package Type	Package Drawing	Pins	SPQ	Length (mm)	Width (mm)	Height (mm)
CSD17559Q5	SON	DQH	8	2500	335.0	335.0	32.0

## IMPORTANT NOTICE

Texas Instruments Incorporated and its subsidiaries (TI) reserve the right to make corrections, enhancements, improvements and other changes to its semiconductor products and services per JESD46, latest issue, and to discontinue any product or service per JESD48, latest issue. Buyers should obtain the latest relevant information before placing orders and should verify that such information is current and complete. All semiconductor products (also referred to herein as "components") are sold subject to TI's terms and conditions of sale supplied at the time of order acknowledgment.

TI warrants performance of its components to the specifications applicable at the time of sale, in accordance with the warranty in TI's terms and conditions of sale of semiconductor products. Testing and other quality control techniques are used to the extent TI deems necessary to support this warranty. Except where mandated by applicable law, testing of all parameters of each component is not necessarily performed.

TI assumes no liability for applications assistance or the design of Buyers' products. Buyers are responsible for their products and applications using TI components. To minimize the risks associated with Buyers' products and applications, Buyers should provide adequate design and operating safeguards.

TI does not warrant or represent that any license, either express or implied, is granted under any patent right, copyright, mask work right, or other intellectual property right relating to any combination, machine, or process in which TI components or services are used. Information published by TI regarding third-party products or services does not constitute a license to use such products or services or a warranty or endorsement thereof. Use of such information may require a license from a third party under the patents or other intellectual property of the third party, or a license from TI under the patents or other intellectual property of TI.

Reproduction of significant portions of TI information in TI data books or data sheets is permissible only if reproduction is without alteration and is accompanied by all associated warranties, conditions, limitations, and notices. TI is not responsible or liable for such altered documentation. Information of third parties may be subject to additional restrictions.

Resale of TI components or services with statements different from or beyond the parameters stated by TI for that component or service voids all express and any implied warranties for the associated TI component or service and is an unfair and deceptive business practice. TI is not responsible or liable for any such statements.

Buyer acknowledges and agrees that it is solely responsible for compliance with all legal, regulatory and safety-related requirements concerning its products, and any use of TI components in its applications, notwithstanding any applications-related information or support that may be provided by TI. Buyer represents and agrees that it has all the necessary expertise to create and implement safeguards which anticipate dangerous consequences of failures, monitor failures and their consequences, lessen the likelihood of failures that might cause harm and take appropriate remedial actions. Buyer will fully indemnify TI and its representatives against any damages arising out of the use of any TI components in safety-critical applications.

In some cases, TI components may be promoted specifically to facilitate safety-related applications. With such components, TI's goal is to help enable customers to design and create their own end-product solutions that meet applicable functional safety standards and requirements. Nonetheless, such components are subject to these terms.

No TI components are authorized for use in FDA Class III (or similar life-critical medical equipment) unless authorized officers of the parties have executed a special agreement specifically governing such use.

Only those TI components which TI has specifically designated as military grade or "enhanced plastic" are designed and intended for use in military/aerospace applications or environments. Buyer acknowledges and agrees that any military or aerospace use of TI components which have **not** been so designated is solely at the Buyer's risk, and that Buyer is solely responsible for compliance with all legal and regulatory requirements in connection with such use.

TI has specifically designated certain components as meeting ISO/TS16949 requirements, mainly for automotive use. In any case of use of non-designated products, TI will not be responsible for any failure to meet ISO/TS16949.

### Products

Audio	<a href="http://www.ti.com/audio">www.ti.com/audio</a>
Amplifiers	<a href="http://amplifier.ti.com">amplifier.ti.com</a>
Data Converters	<a href="http://dataconverter.ti.com">dataconverter.ti.com</a>
DLP® Products	<a href="http://www.dlp.com">www.dlp.com</a>
DSP	<a href="http://dsp.ti.com">dsp.ti.com</a>
Clocks and Timers	<a href="http://www.ti.com/clocks">www.ti.com/clocks</a>
Interface	<a href="http://interface.ti.com">interface.ti.com</a>
Logic	<a href="http://logic.ti.com">logic.ti.com</a>
Power Mgmt	<a href="http://power.ti.com">power.ti.com</a>
Microcontrollers	<a href="http://microcontroller.ti.com">microcontroller.ti.com</a>
RFID	<a href="http://www.ti-rfid.com">www.ti-rfid.com</a>
OMAP Applications Processors	<a href="http://www.ti.com/omap">www.ti.com/omap</a>
Wireless Connectivity	<a href="http://www.ti.com/wirelessconnectivity">www.ti.com/wirelessconnectivity</a>

### Applications

Automotive and Transportation	<a href="http://www.ti.com/automotive">www.ti.com/automotive</a>
Communications and Telecom	<a href="http://www.ti.com/communications">www.ti.com/communications</a>
Computers and Peripherals	<a href="http://www.ti.com/computers">www.ti.com/computers</a>
Consumer Electronics	<a href="http://www.ti.com/consumer-apps">www.ti.com/consumer-apps</a>
Energy and Lighting	<a href="http://www.ti.com/energy">www.ti.com/energy</a>
Industrial	<a href="http://www.ti.com/industrial">www.ti.com/industrial</a>
Medical	<a href="http://www.ti.com/medical">www.ti.com/medical</a>
Security	<a href="http://www.ti.com/security">www.ti.com/security</a>
Space, Avionics and Defense	<a href="http://www.ti.com/space-avionics-defense">www.ti.com/space-avionics-defense</a>
Video and Imaging	<a href="http://www.ti.com/video">www.ti.com/video</a>

### TI E2E Community

[e2e.ti.com](http://e2e.ti.com)