

SIEMENS AKTIENGESELLSCHAFT

Main ratings

Drain-source voltage $V_{DS} = 800$ V
 Continuous drain current $I_D = 3,6$ A
 Drain-source on-resistance $R_{DS(on)} = 3,0 \Omega$

N-Channel

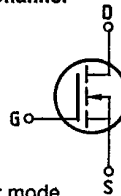

Description FREDET with fast-recovery reverse diode, N-channel, enhancement mode
Case Plastic package 15 in accordance with DIN 41869 or TO 218 AA (TOP 3) in accordance with JEDEC.
 The drain terminal is conductively connected to the mounting flange.
 Approx. weight 4,5 g

Type	Ordering code
BUZ 360	C67078-A3204-A2

Available from Sep 1987

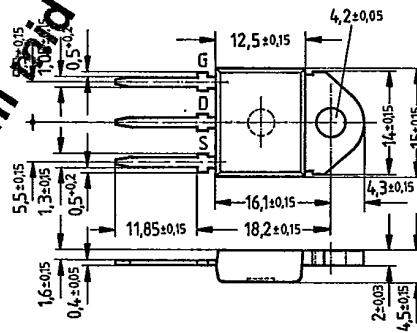

Dimensions in mm

Maximum ratings

Description	Symbols	Ratings	Units	Conditions
Drain-source voltage	V_{DS}	800	V	
Drain-gate voltage	V_{DGR}	800	V	$R_{GS} = 20 \text{ k}\Omega$
Continuous drain current	I_D	3,6	A	$T_C = 25 \text{ }^\circ\text{C}$
Pulsed drain current	I_{Dpuls}	14	A	$T_C = 25 \text{ }^\circ\text{C}$
Gate-source voltage	V_{GS}	± 20	V	
Max. power dissipation	P_D	75	W	$T_C = 25 \text{ }^\circ\text{C}$
Operating and storage temperature range	T_j T_{stg}	$-55 \dots +150$	$^\circ\text{C}$	
DIN humidity category		E	-	DIN 40 040
IEC climatic category		55/150/56	-	DIN IEC 68-1

Thermal resistance

Chip - case	$R_{th JC}$	$\leq 1,67$	K/W
Chip - ambient	$R_{th JA}$	≤ 45	K/W

SIEMENS AKTIENGESELLSCHAFT

Electrical characteristics

(at $T_j = 25^\circ\text{C}$ unless otherwise specified)

Description	Symbol	Characteristics			Unit	Conditions
		min.	typ.	max.		
Static ratings						
Drain-source breakdown voltage	$V_{(BR)DSS}$	800	—	—	V	$V_{GS} = 0V$ $I_D = 0,25mA$
Gate threshold voltage	$V_{GS(th)}$	2,1	3,0	4,0		$V_{DS} = V_{GS}$ $I_D = 1mA$
Zero gate voltage drain current	I_{DSS}	—	20	250	μA	$T_j = 25^\circ\text{C}$ $T_j = 125^\circ\text{C}$ $V_{DS} = 800V$ $V_{GS} = 0V$
Gate-source leakage current	I_{GSS}	—	10	100	nA	$V_{GS} = 20V$ $V_{DS} = 0V$
Drain-source on-resistance	$R_{DS(on)}$	—	2,0	3,0	Ω	$V_{GS} = 10V$ $I_D = 2,3A$
Dynamic ratings						
Forward transconductance	g_{fs}	1,0	2,4	—	S	$V_{DS} = 25V$ $I_D = 2,3A$
Input capacitance	C_{iss}	—	1,6	2,1	nF	$V_{GS} = 0V$ $V_{DS} = 25V$ $f = 1MHz$
Output capacitance	C_{oss}	—	90	150	pF	
Reverse transfer capacitance	C_{rss}	—	30	55		
Turn-on time t_{on} ($t_{on} = t_{d(on)} + t_r$)	$t_{d(on)}$	—	30	45	ns	$V_{CC} = 30V$ $I_D = 2,3A$ $V_{GS} = 10V$ $R_{GS} = 50\Omega$
	t_r	—	50	60		
Turn-off time t_{off} ($t_{off} = t_{d(off)} + t_f$)	$t_{d(off)}$	—	100	140		
	t_f	—	60	80		
Fast-recovery reverse diode						
Continuous reverse drain current	I_{DR}	—	—	3,6	A	$T_C = 25^\circ\text{C}$
Pulsed reverse drain current	I_{DRM}	—	—	14		
Diode forward on-voltage	V_{SD}	—	1,15	1,5	V	$I_F = 2 \times I_{DR}$ $V_{GS} = 0V, T_j = 25^\circ\text{C}$
Reverse recovery time	t_{rr}	—	180	250	ns	$T_j = 25^\circ\text{C}$ $T_j = 150^\circ\text{C}$ $I_F = I_{DR}$ $df/dt = 100A/\mu s$ $V_R = 100V$
		—	220	300		
Reverse recovery charge	Q_{rr}	—	0,85	1,2	μC	
		—	2,6	5,0		
Repetitive peak reverse current	I_{RRM}	—	—	—	A	
		—	15	—		$T_j = 25^\circ\text{C}$ $T_j = 150^\circ\text{C}$

SIEMENS AKTIENGESELLSCHAFT

Power dissipation $P_D = f(T_C)$

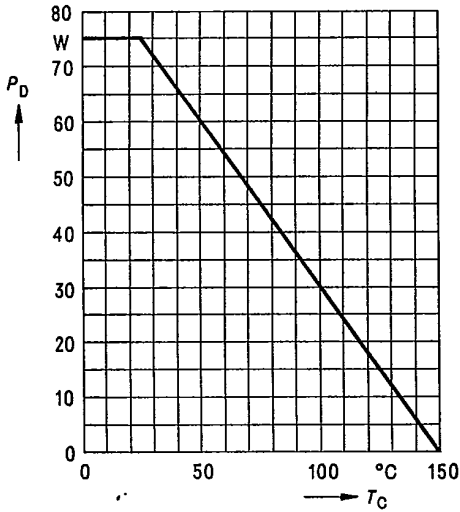

Typical output characteristics $I_D = f(V_{DS})$
parameter: 80 μ s pulse test,
 $T_J = 25^\circ\text{C}$

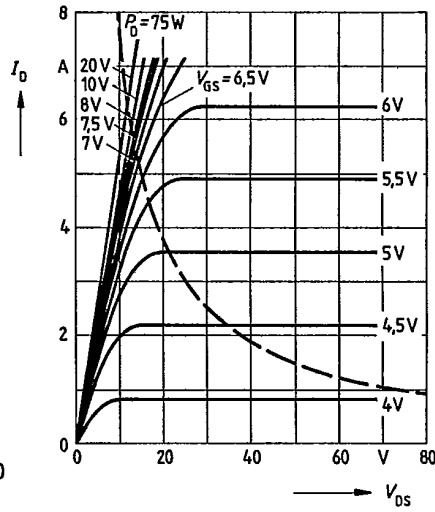

Safe operating area $I_D = f(V_{DS})$
parameter: $D = 0.01$, $T_C = 25^\circ\text{C}$

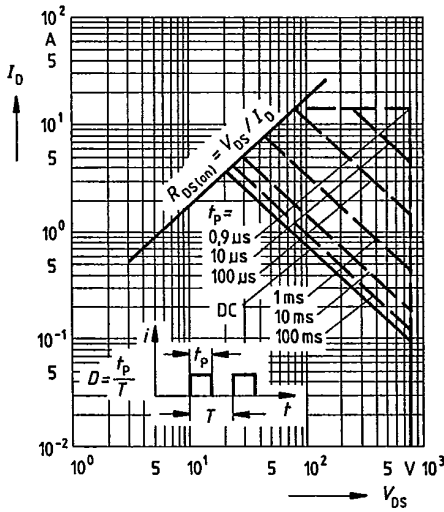

Typical transfer characteristic $I_D = f(V_{GS})$
parameter: 80 μ s pulse test,
 $V_{DS} = 25\text{V}$, $T_J = 25^\circ\text{C}$

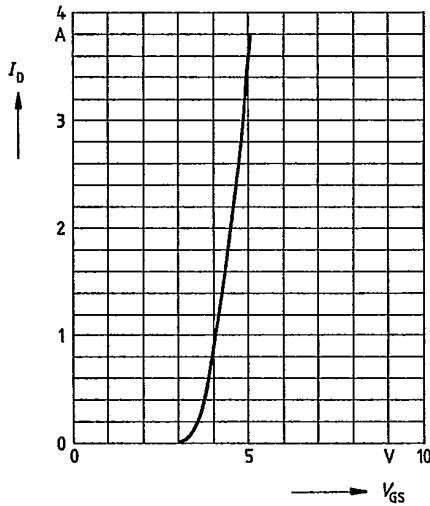

SIEMENS AKTIENGESELLSCHAFT

Typical drain-source on-state resistance

$R_{DS(on)} = f(I_D)$
parameter: $V_{GS} = T_j = 25^\circ\text{C}$

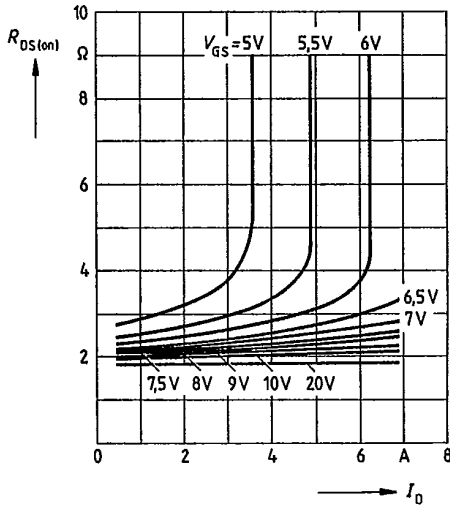

Drain-source on-state resistance

$R_{DS(on)} = f(T_j)$
parameter: $I_D = 2.3\text{A}, V_{GS} = 10\text{V}$
(spread)

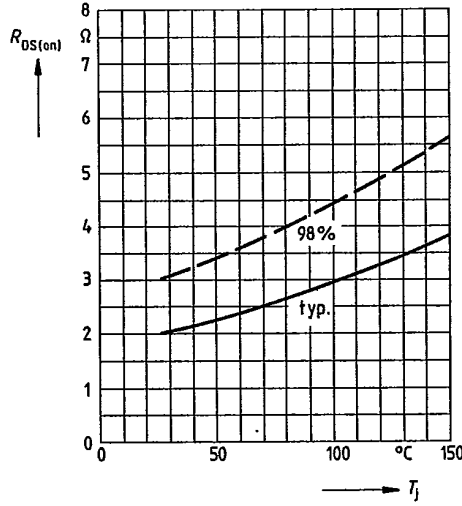

Typical transconductance $g_{fs} = f(I_D)$

parameter: 80 μs pulse test,
 $V_{DS} = 25\text{V}, T_j = 25^\circ\text{C}$

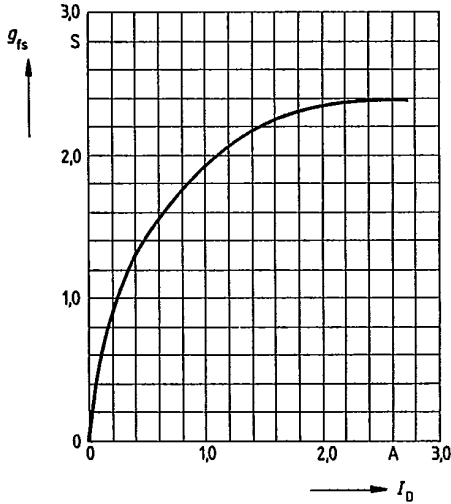

Gate threshold voltage $V_{GS(th)} = f(T_j)$

parameter: $V_{DS} = V_{GS}, I_D = 1\text{mA}$
(spread)

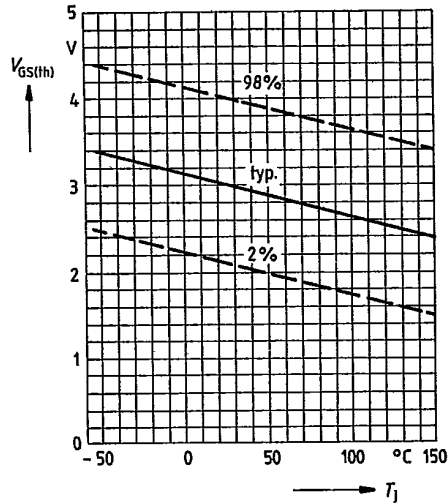

— SIEMENS AKTIENGESELLSCHAFT —

Typical capacitances $C = f(V_{DS})$
 parameter: $V_{GS} = 0, f = 1\text{MHz}$

Continuous drain current $I_D = f(T_C)$
 parameter: $V_{GS} \geq 10\text{V}$

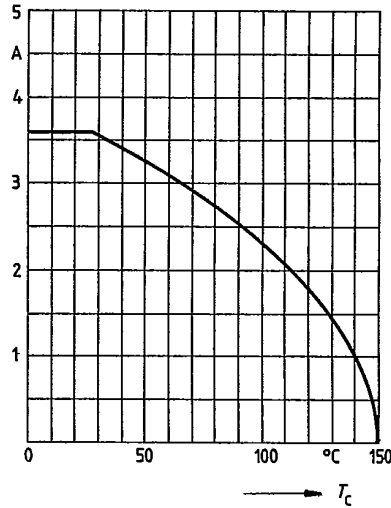
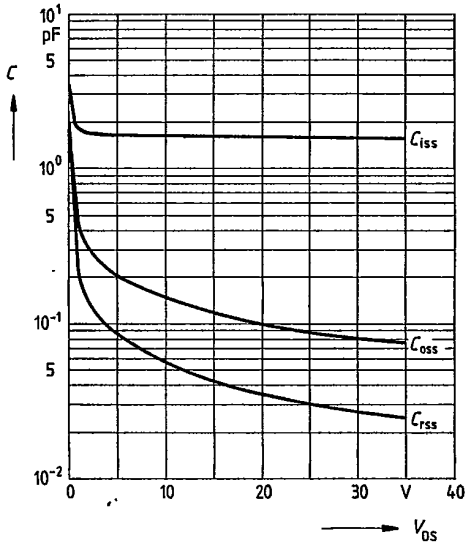

Forward characteristic of reverse diode

$I_F = f(V_{SD})$
 parameter: $T_j, t_p = 80 \mu\text{s}$
 (spread)

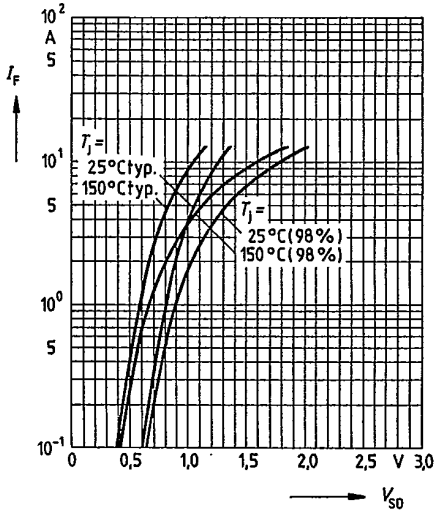

782

1364

G-01

— SIEMENS AKTIENGESELLSCHAFT —

Transient thermal impedance $Z_{thJC} = f(t)$
 parameter: $D = t_p/T$

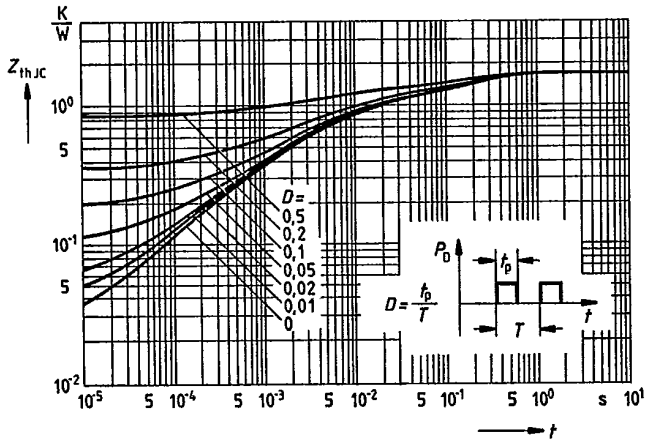

Typical gate-charge $V_{GS} = f(Q_{Gate})$
 parameter: $I_D \text{ pulse} = 5A$

