

Main ratings

Drain-source voltage $V_{DS} = 500$ V
 Continuous drain current $I_D = 8$ A
 Drain-source on-resistance $R_{DS(on)} = 0,8 \Omega$

N-Channel

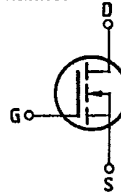

Description SIPMOS, N-channel, enhancement mode
Case Plastic package 15 in accordance with DIN 41 869 or TO 218 AA (TOP 3) in accordance with JEDEC.
 The drain terminal is conductively connected to the mounting flange.
 Approx. weight 4,5 g

Type	Ordering code
BUZ 354	C67078-A3106-A2

Not for new design

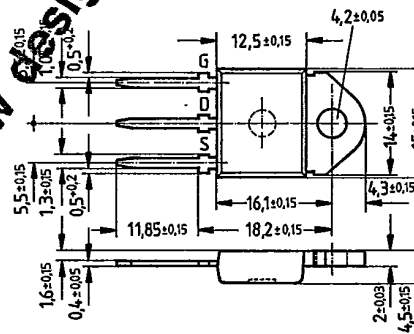

Dimensions in mm

Maximum ratings

Description	Symbols	Ratings	Units	Conditions
Drain-source voltage	V_{DS}	500	V	
Drain-gate voltage	V_{DGR}	500	V	$R_{GS} = 20 \text{ k}\Omega$
Continuous drain current	I_D	8	A	$T_C = 35 \text{ }^\circ\text{C}$
Pulsed drain current	I_{Dpuls}	32	A	$T_C = 25 \text{ }^\circ\text{C}$
Gate-source voltage	V_{GS}	± 20	V	
Max. power dissipation	P_D	125	W	$T_C = 25 \text{ }^\circ\text{C}$
Operating and storage temperature range	T_J T_{stg}	$-55 \dots +150$	$^\circ\text{C}$	
DIN humidity category	E			DIN 40040
IEC climatic category		55/150/56		DIN IEC 68-1

Thermal resistance

Chip – case	R_{thJC}	$\leq 1,0$	K/W
Chip – ambient	R_{thJA}	≤ 45	K/W

748 Preferred Type

1330 0-09

Electrical characteristics

(at $T_j = 25^\circ\text{C}$ unless otherwise specified)

Description	Symbol	Characteristics			Unit	Conditions
		min.	typ.	max.		

Static ratings

Drain-source breakdown voltage	$V_{(BR)DSS}$	500	—	—	V	$V_{GS} = 0V$ $I_D = 0,25mA$
Gate threshold voltage	$V_{GS(th)}$	2,1	3,0	4,0		$V_{DS} = V_{GS}$ $I_D = 1mA$
Zero gate voltage drain current	I_{DSS}	—	20	250	μA	$T_j = 25^\circ\text{C}$ $T_j = 125^\circ\text{C}$ $V_{DS} = 500V$ $V_{GS} = 0V$
Gate-source leakage current	I_{GSS}	—	10	100	nA	$V_{GS} = 20V$ $V_{DS} = 0V$
Drain-source on-resistance	$R_{DS(on)}$	—	0,7	0,8	Ω	$V_{GS} = 10V$ $I_D = 5,5A$

Dynamic ratings

Forward transconductance	g_{fs}	2,7	5,0	—	S	$V_{DS} = 25V$ $I_D = 5,5A$
Input capacitance	C_{iss}	—	3,8	4,9	nF	$V_{GS} = 0V$
Output capacitance	C_{oss}	—	250	400	pF	$V_{DS} = 25V$ $f = 1MHz$
Reverse transfer capacitance	C_{rss}	—	100	170		
Turn-on time t_{on} ($t_{on} = t_{d(on)} + t_r$)	$t_{d(on)}$	—	50	75	ns	$V_{CC} = 30V$ $I_D = 2,8A$ $V_{GS} = 10V$ $R_{GS} = 50\Omega$
	t_r	—	80	120		
Turn-off time t_{off} ($t_{off} = t_{d(off)} + t_f$)	$t_{d(off)}$	—	330	430		
	t_f	—	110	140		

Reverse diode

Continuous reverse drain current	I_{DR}	—	—	8,0	A	$T_C = 25^\circ\text{C}$
Pulsed reverse drain current	I_{DRM}	—	—	32		
Diode forward on-voltage	V_{SD}	—	1,3	1,6	V	$I_F = 2 \times I_{DR}$ $V_{GS} = 0V, T_j = 25^\circ\text{C}$
Reverse recovery time	t_{rr}	—	1200	—	ns	$T_j = 25^\circ\text{C}$
Reverse recovery charge	Q_{rr}	—	12	—	μC	$I_F = I_{DR}$ $dI_F/dt = 100A/\mu s$ $V_R = 100V$

Power dissipation $P_D = f(T_C)$

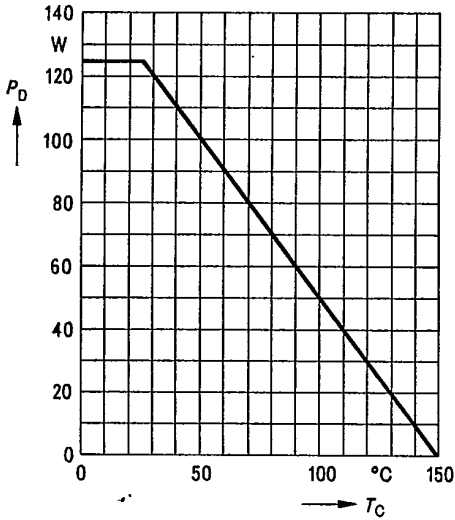

Typical output characteristics $I_D = f(V_{DS})$
parameter: 80 μ s pulse test,
 $T_j = 25^\circ\text{C}$

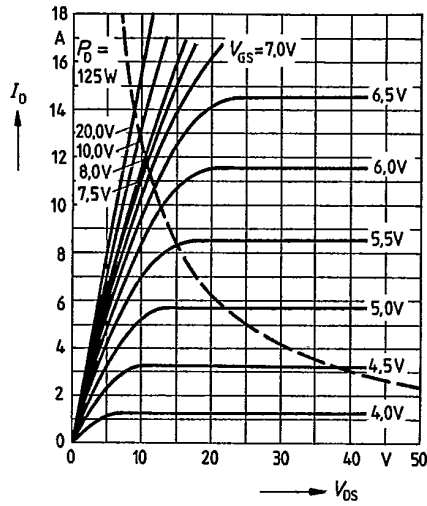

Safe operating area $I_D = f(V_{DS})$
parameter: $D = 0.01$, $T_C = 25^\circ\text{C}$

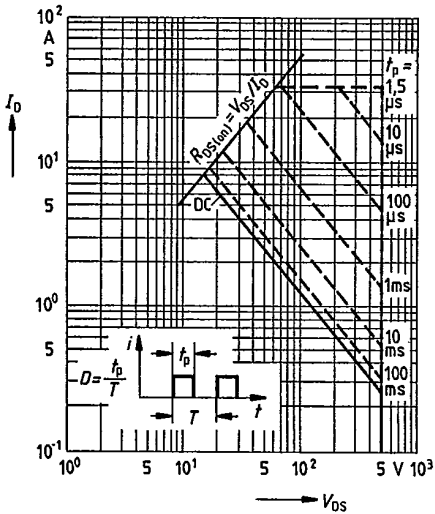

Typical transfer characteristic $I_D = f(V_{GS})$
parameter: 80 μ s pulse test,
 $V_{DS} = 25\text{V}$, $T_j = 25^\circ\text{C}$

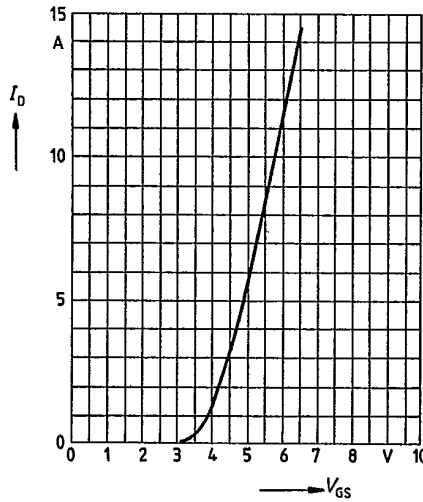

Typical drain-source on-state resistance

$R_{DS(on)} = f(I_D)$
parameter: V_{GS} ; $T_j = 25^\circ\text{C}$

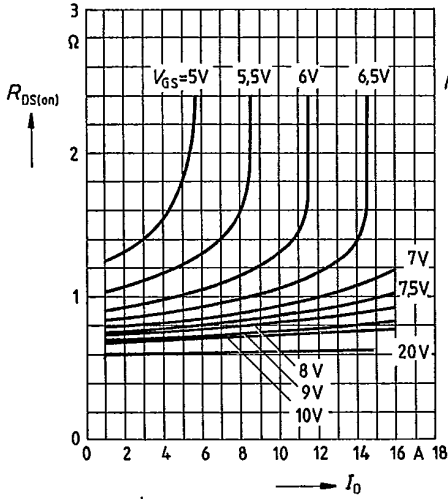

Drain-source on-state resistance

$R_{DS(on)} = f(T_j)$
parameter: $I_D = 5.5\text{A}$, $V_{GS} = 10\text{V}$
(spread)

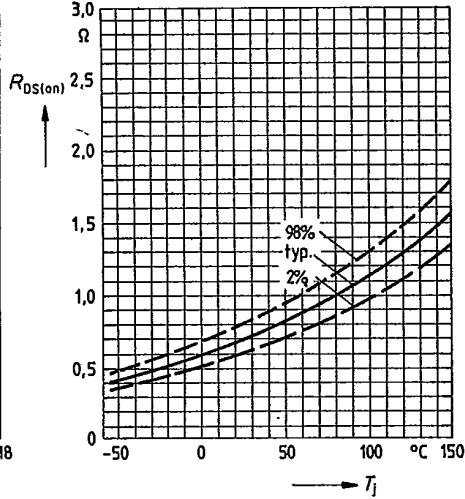

Typical transconductance $g_{fs} = f(I_D)$

parameter: 80 μs pulse test,
 $V_{DS} = 25\text{V}$, $T_j = 25^\circ\text{C}$

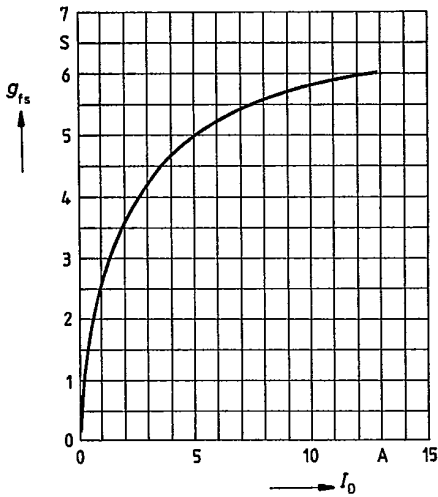

Gate threshold voltage $V_{GS(th)} = f(T_j)$

parameter: $V_{DS} = V_{GS}$, $I_D = 1\text{mA}$
(spread)

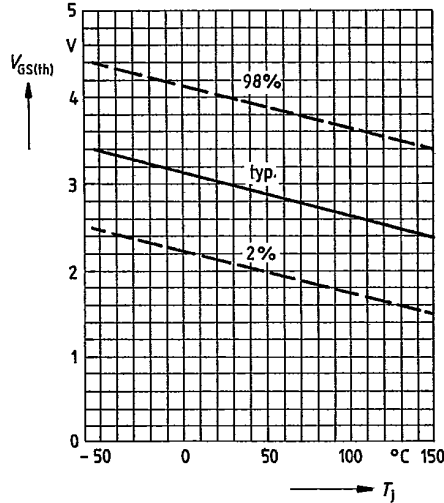

Typical capacitances $C = f(V_{DS})$
 parameter: $V_{GS} = 0, f = 1\text{MHz}$

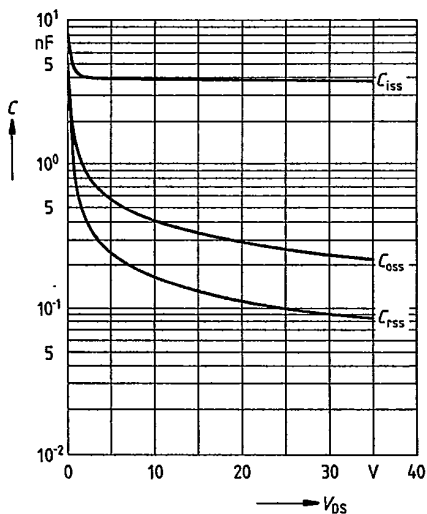

Continuous drain current $I_D = f(T_C)$
 parameter: $V_{GS} \geq 10\text{V}$

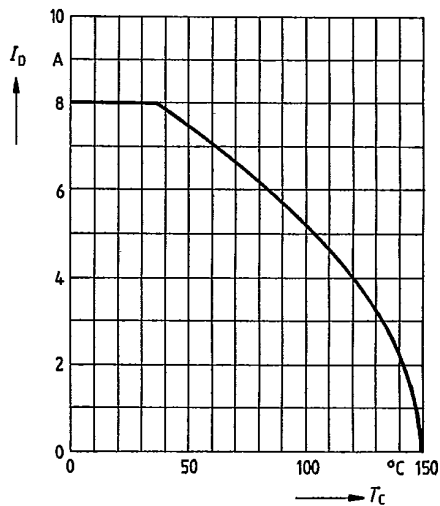

Forward characteristic of reverse diode

$I_F = f(V_{SD})$
 parameter: $T_j, t_p = 80 \mu\text{s}$
 (spread)

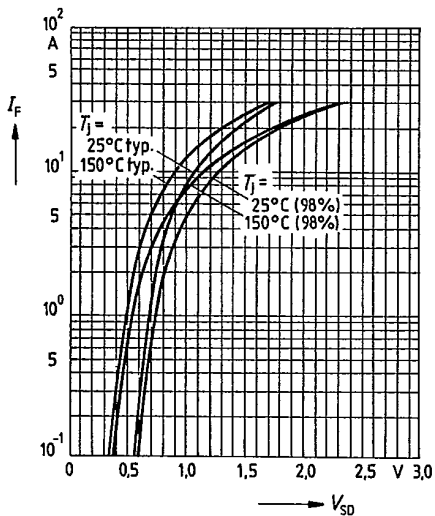

752

1334

D-13

Transient thermal impedance $Z_{thJC} = f(t)$
 parameter: $D = t_p / T$

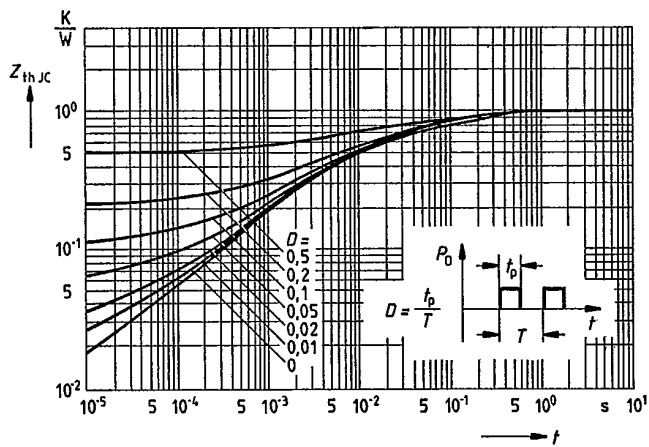

Typical gate-charge $V_{GS} = f(Q_{Gate})$
 parameter: $I_{D,puls} = 14,4A$

