

AUIRF7478Q

HEXFET® Power MOSFET

Features

- Advanced Planar Technology
- Low On-Resistance
- Dynamic dV/dT Rating
- 150°C Operating Temperature
- Fast Switching
- Fully Avalanche Rated
- Repetitive Avalanche Allowed up to Tjmax
- Lead-Free, RoHS Compliant
- Automotive Qualified *

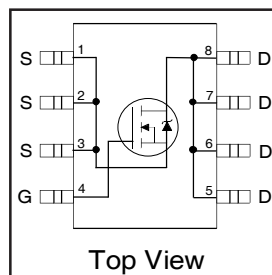

$V_{(BR)DSS}$		60V
$R_{DS(on)}$	typ.	20mΩ
	max.	26mΩ
I_D		7.0A

Description

Specifically designed for Automotive applications, this Cellular design of HEXFET® Power MOSFETs utilizes the latest processing techniques to achieve low on-resistance per silicon area. This benefit combined with the fast switching speed and ruggedized device design that HEXFET power MOSFETs are well known for, provides the designer with an extremely efficient and reliable device for use in Automotive and a wide variety of other applications.

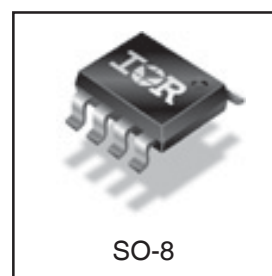

G	D	S
Gate	Drain	Source

Absolute Maximum Ratings

Stresses beyond those listed under “Absolute Maximum Ratings” may cause permanent damage to the device. These are stress ratings only; and functional operation of the device at these or any other condition beyond those indicated in the specifications is not implied. Exposure to absolute-maximum-rated conditions for extended periods may affect device reliability. The thermal resistance and power dissipation ratings are measured under board mounted and still air conditions. Ambient temperature (T_A) is 25°C, unless otherwise specified.

	Parameter	Max.	Units
V_{DS}	Drain-Source Voltage	60	V
$I_D @ T_A = 25^\circ\text{C}$	Continuous Drain Current, $V_{GS} @ 10\text{V}$	7.0	A
$I_D @ T_A = 70^\circ\text{C}$	Continuous Drain Current, $V_{GS} @ 10\text{V}$	5.6	
I_{DM}	Pulsed Drain Current ①	56	
$P_D @ T_A = 25^\circ\text{C}$	Power Dissipation ④	2.5	W
	Linear Derating Factor	0.02	W/°C
V_{GS}	Gate-to-Source Voltage	± 20	V
E_{AS}	Single Pulse Avalanche Energy ②	140	mJ
I_{AR}	Avalanche Current ①	4.2	A
dv/dt	Peak Diode Recovery dv/dt ③	3.7	V/ns
T_J	Operating Junction and	-55 to + 150	°C
T_{STG}	Storage Temperature Range		
	Soldering Temperature, for 10 seconds		

Thermal Resistance

	Parameter	Max.	Units
$R_{\theta JL}$	Junction-to-Drain Lead	20	°C/W
$R_{\theta JA}$	Junction-to-Ambient ④	50	

HEXFET® is a registered trademark of International Rectifier.

*Qualification standards can be found at <http://www.irf.com/>

Static Electrical Characteristics @ $T_J = 25^\circ\text{C}$ (unless otherwise specified)

	Parameter	Min.	Typ.	Max.	Units	Conditions
$V_{(BR)DSS}$	Drain-to-Source Breakdown Voltage	60	—	—	V	$V_{GS} = 0V, I_D = 250\mu A$
$\Delta V_{(BR)DSS}/\Delta T_J$	Breakdown Voltage Temp. Coefficient	—	0.065	—	V/°C	Reference to $25^\circ\text{C}, I_D = 1mA$
$R_{DS(on)}$	Static Drain-to-Source On-Resistance	—	20	26	mΩ	$V_{GS} = 10V, I_D = 4.2A$ ③
		—	23	30		$V_{GS} = 4.5V, I_D = 3.5A$ ③
$V_{GS(th)}$	Gate Threshold Voltage	1.0	—	3.0	V	$V_{DS} = V_{GS}, I_D = 250\mu A$
g_{fs}	Forward Transconductance	17	—	—	S	$V_{DS} = 50V, I_D = 4.2A$
I_{DSS}	Drain-to-Source Leakage Current	—	—	20	μA	$V_{DS} = 48V, V_{GS} = 0V$
		—	—	100		$V_{DS} = 48V, V_{GS} = 0V, T_J = 125^\circ\text{C}$
I_{GSS}	Gate-to-Source Forward Leakage	—	—	100	nA	$V_{GS} = 20V$
	Gate-to-Source Reverse Leakage	—	—	-100		$V_{GS} = -20V$

Dynamic Electrical Characteristics @ $T_J = 25^\circ\text{C}$ (unless otherwise specified)

	Parameter	Min.	Typ.	Max.	Units	Conditions
Q_g	Total Gate Charge	—	21	31	nC	$I_D = 4.2A$
Q_{gs}	Gate-to-Source Charge	—	4.3	—		$V_{DS} = 48V$
Q_{gd}	Gate-to-Drain ("Miller") Charge	—	9.6	—		$V_{GS} = 4.5V$
$t_{d(on)}$	Turn-On Delay Time	—	7.7	—	ns	$V_{DD} = 30V$
t_r	Rise Time	—	2.6	—		$I_D = 4.2A$
$t_{d(off)}$	Turn-Off Delay Time	—	44	—		$R_G = 6.2\Omega$
t_f	Fall Time	—	13	—		$V_{GS} = 10V$ ③
C_{iss}	Input Capacitance	—	1740	—	pF	$V_{GS} = 0V$
C_{oss}	Output Capacitance	—	300	—		$V_{DS} = 25V$
C_{riss}	Reverse Transfer Capacitance	—	37	—		$f = 1.0MHz$
C_{oss}	Output Capacitance	—	1590	—		$V_{GS} = 0V, V_{DS} = 1.0V, f = 1.0MHz$
C_{oss}	Output Capacitance	—	220	—		$V_{GS} = 0V, V_{DS} = 48V, f = 1.0MHz$
C_{oss}	Output Capacitance	—	410	—		$V_{GS} = 0V, V_{DS} = 0V \text{ to } 48V$ ⑤
C_{oss}	Output Capacitance	—	410	—		

Diode Characteristics

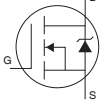
	Parameter	Min.	Typ.	Max.	Units	Conditions
I_S	Continuous Source Current (Body Diode)	—	—	2.3	A	MOSFET symbol showing the integral reverse p-n junction diode. 
I_{SM}	Pulsed Source Current (Body Diode) ①	—	—	56		
V_{SD}	Diode Forward Voltage	—	—	1.3	V	$T_J = 25^\circ\text{C}, I_S = 4.2A, V_{GS} = 0V$ ③
t_{rr}	Reverse Recovery Time	—	52	78	ns	$T_J = 25^\circ\text{C}, I_F = 4.2A$
Q_{rr}	Reverse Recovery Charge	—	100	150	nC	$di/dt = 100A/\mu s$ ③

Notes:

- ① Repetitive rating; pulse width limited by max. junction temperature.
- ② Starting $T_J = 25^\circ\text{C}, L = 16mH$
 $R_G = 25\Omega, I_{AS} = 4.2A.$
- ③ Pulse width $\leq 400\mu s$; duty cycle $\leq 2\%$.
- ④ When mounted on 1 inch square copper board
- ⑤ C_{oss} eff. is a fixed capacitance that gives the same charging time as C_{oss} while V_{DS} is rising from 0 to 80% V_{DSS}
- ⑥ $I_{SD} \leq 4.2A, di/dt \leq 160A/\mu s, V_{DD} \leq V_{(BR)DSS}, T_J \leq 150^\circ\text{C}$

Qualification Information[†]

Qualification Level		Automotive (per AEC-Q101) ^{††}	
		Comments: This part number(s) passed Automotive qualification. IR's Industrial and Consumer qualification level is granted by extension of the higher Automotive level.	
Moisture Sensitivity Level		SO-8	MSL1
ESD	Machine Model	Class M3(+/- 300V) ^{†††} (per AEC-Q101-002)	
	Human Body Model	Class H1C(+/- 2000V) ^{†††} (per AEC-Q101-001)	
	Charged Device Model	Class C5(+/- 2000V) ^{†††} (per AEC-Q101-005)	
RoHS Compliant		Yes	

† Qualification standards can be found at International Rectifier's web site: <http://www.irf.com/>

†† Exceptions (if any) to AEC-Q101 requirements are noted in the qualification report.

††† Highest passing voltage

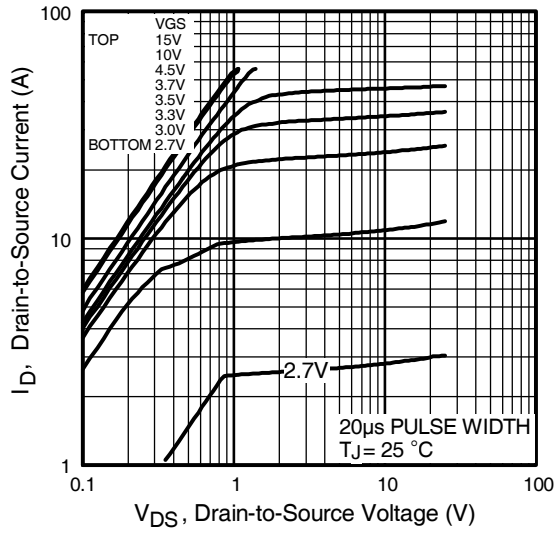

Fig 1. Typical Output Characteristics

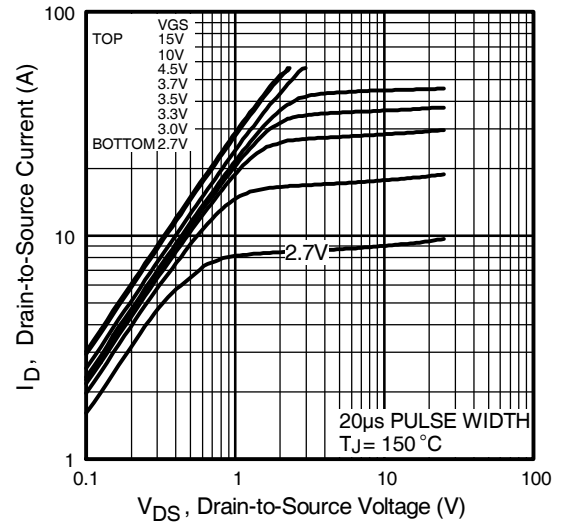

Fig 2. Typical Output Characteristics

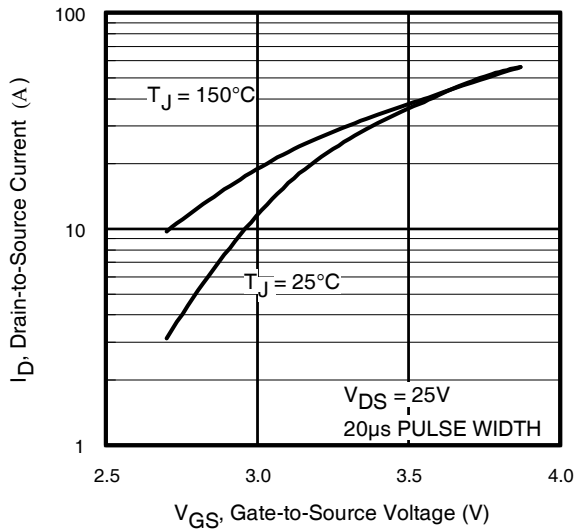

Fig 3. Typical Transfer Characteristics

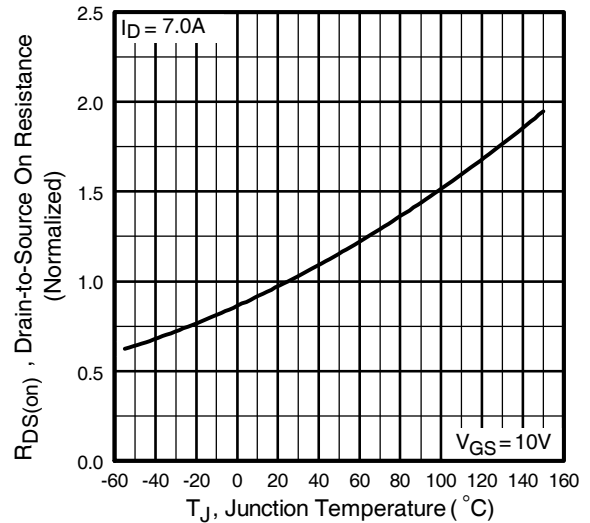

Fig 4. Normalized On-Resistance Vs. Temperature

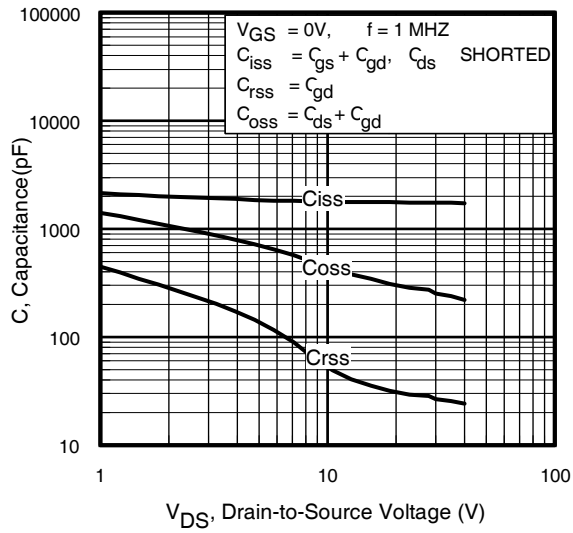

Fig 5. Typical Capacitance Vs. Drain-to-Source Voltage

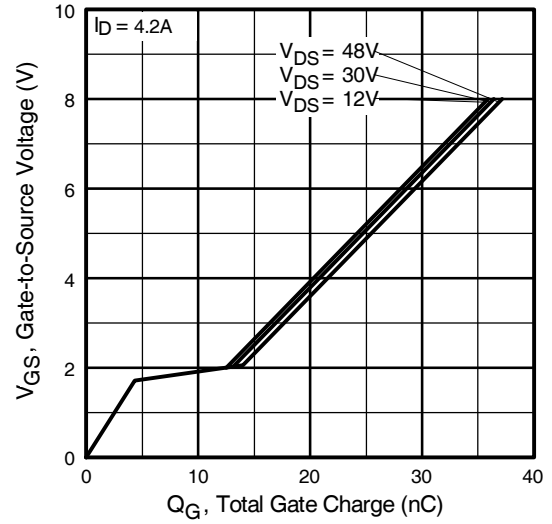

Fig 6. Typical Gate Charge Vs. Gate-to-Source Voltage

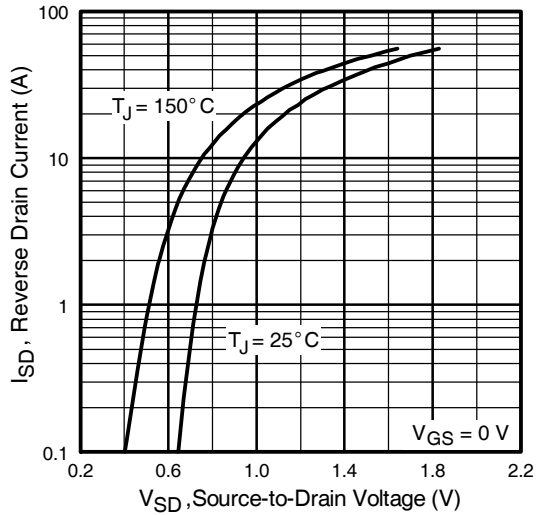

Fig 7. Typical Source-Drain Diode Forward Voltage

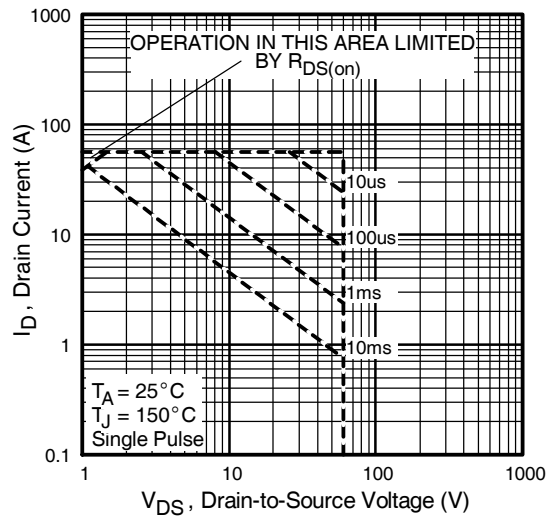

Fig 8. Maximum Safe Operating Area

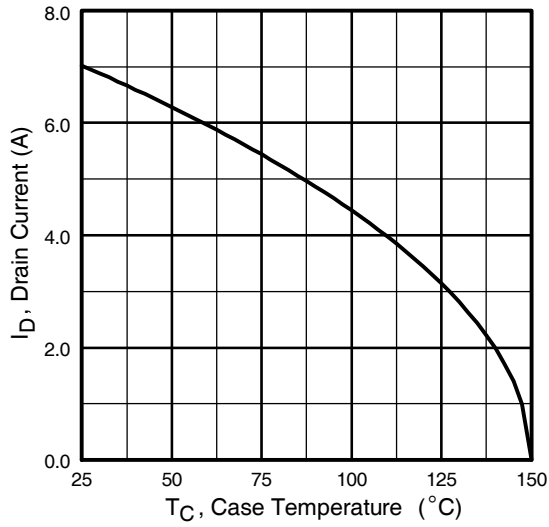

Fig 9. Maximum Drain Current Vs. Ambient Temperature

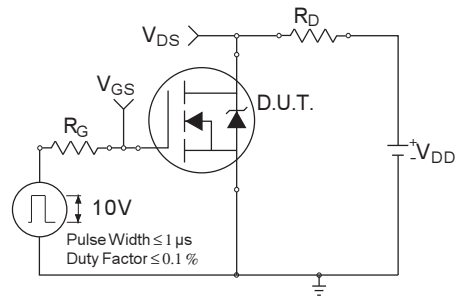

Fig 10a. Switching Time Test Circuit

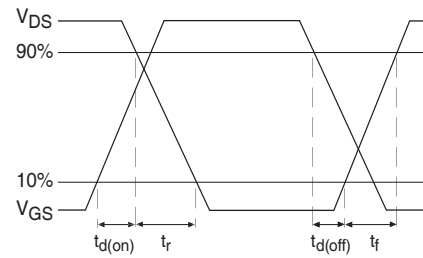

Fig 10b. Switching Time Waveforms

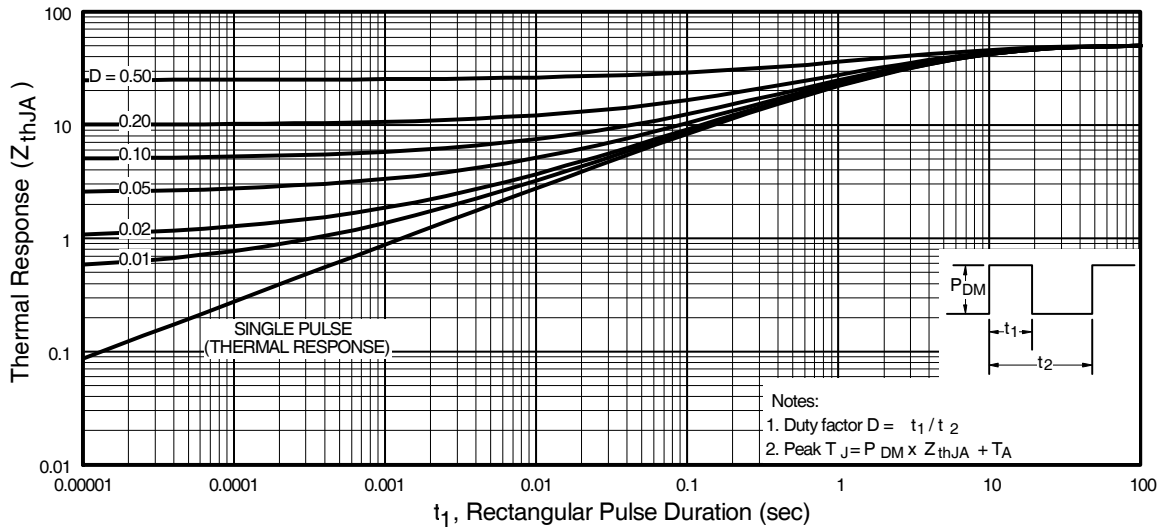

Fig 11. Maximum Effective Transient Thermal Impedance, Junction-to-Ambient

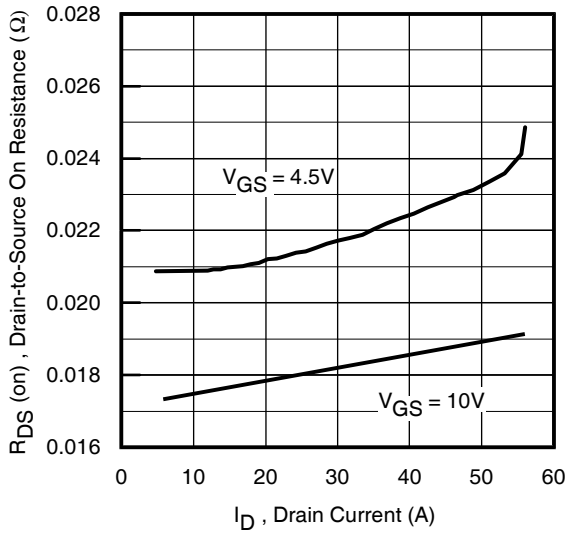

Fig 12. On-Resistance Vs. Drain Current

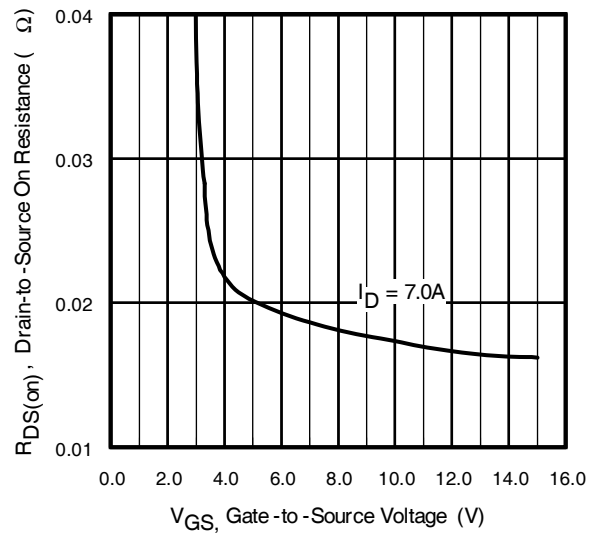

Fig 13. On-Resistance Vs. Gate Voltage

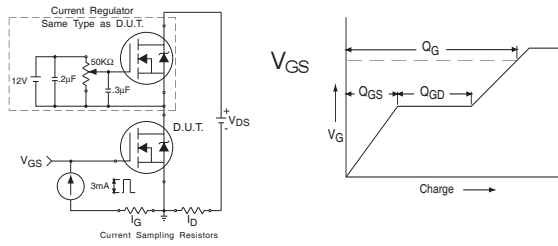

Fig 14a&b. Basic Gate Charge Test Circuit and Waveform

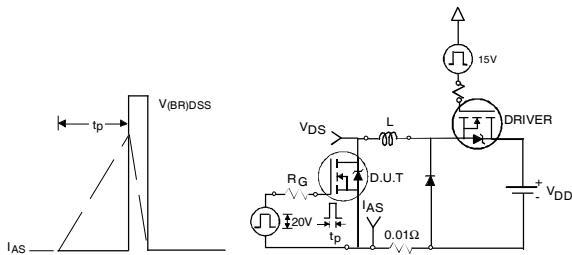

Fig 15a&b. Unclamped Inductive Test circuit and Waveforms

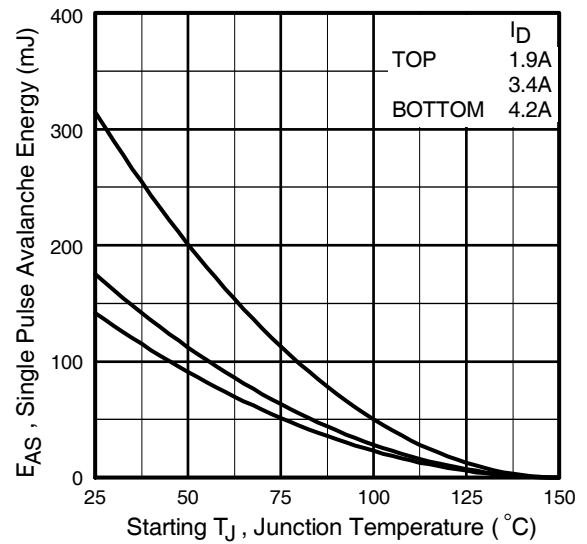
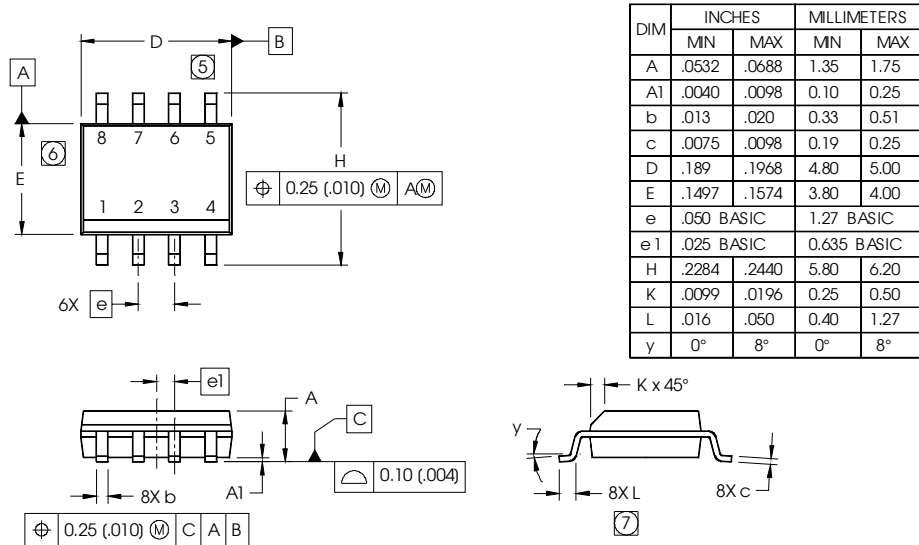

Fig 15c. Maximum Avalanche Energy Vs. Drain Current

SO-8 Package Outline

Dimensions are shown in millimeters (inches)



- NOTES:
1. DIMENSIONING & TOLERANCING PER ASME Y14.5M-1994.
 2. CONTROLLING DIMENSION: MILLIMETER
 3. DIMENSIONS ARE SHOWN IN MILLIMETERS (INCHES).
 4. OUTLINE CONFORMS TO JEDEC OUTLINE MS-012AA.
 5. DIMENSION DOES NOT INCLUDE MOLD PROTRUSIONS. MOLD PROTRUSIONS NOT TO EXCEED 0.15 (.006).
 6. DIMENSION DOES NOT INCLUDE MOLD PROTRUSIONS. MOLD PROTRUSIONS NOT TO EXCEED 0.25 (.010).
 7. DIMENSION IS THE LENGTH OF LEAD FOR SOLDERING TO A SUBSTRATE.

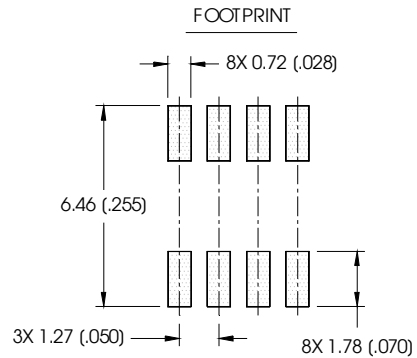

SO-8 Part Marking

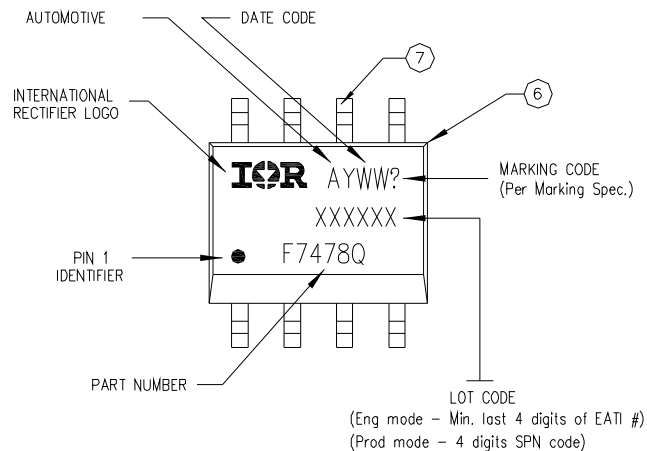

TOP MARKING (LASER)

Note: For the most current drawing please refer to IR website at <http://www.irf.com/package/>

SO-8 Tape and Reel

Dimensions are shown in millimeters (inches)

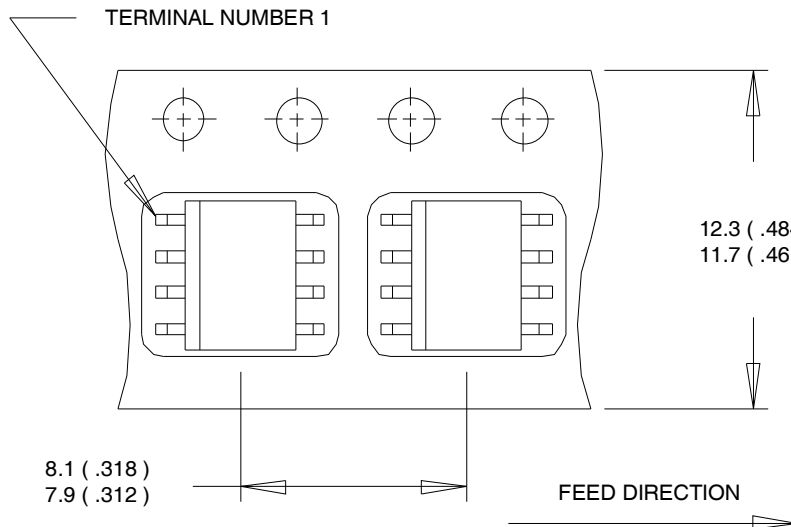

NOTES:

1. CONTROLLING DIMENSION : MILLIMETER.
2. ALL DIMENSIONS ARE SHOWN IN MILLIMETERS(INCHES).
3. OUTLINE CONFORMS TO EIA-481 & EIA-541.

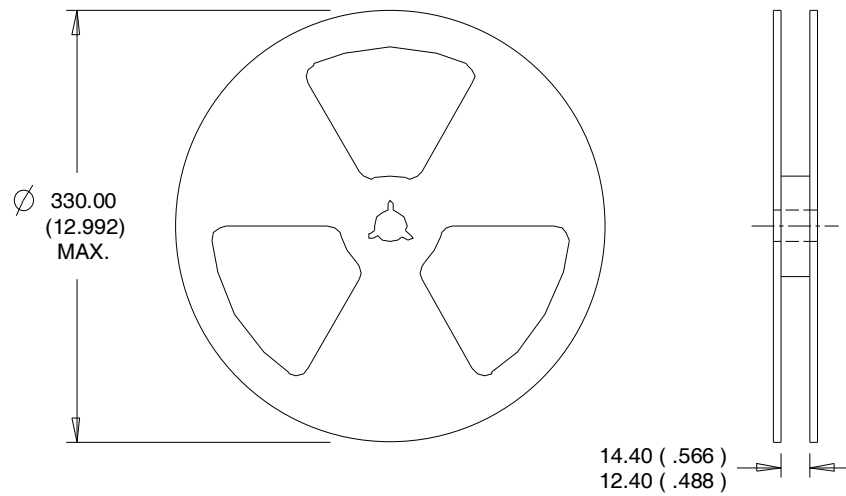

NOTES :

1. CONTROLLING DIMENSION : MILLIMETER.
2. OUTLINE CONFORMS TO EIA-481 & EIA-541.

Ordering Information

Base part	Package Type	Standard Pack		Complete Part Number
		Form	Quantity	
AUIRF7478Q	SO-8	Tube	95	AUIRF7478Q
		Tape and Reel	4000	AUIRF7478QTR

IMPORTANT NOTICE

Unless specifically designated for the automotive market, International Rectifier Corporation and its subsidiaries (IR) reserve the right to make corrections, modifications, enhancements, improvements, and other changes to its products and services at any time and to discontinue any product or services without notice. Part numbers designated with the “AU” prefix follow automotive industry and / or customer specific requirements with regards to product discontinuance and process change notification. All products are sold subject to IR’s terms and conditions of sale supplied at the time of order acknowledgment.

IR warrants performance of its hardware products to the specifications applicable at the time of sale in accordance with IR’s standard warranty. Testing and other quality control techniques are used to the extent IR deems necessary to support this warranty. Except where mandated by government requirements, testing of all parameters of each product is not necessarily performed.

IR assumes no liability for applications assistance or customer product design. Customers are responsible for their products and applications using IR components. To minimize the risks with customer products and applications, customers should provide adequate design and operating safeguards.

Reproduction of IR information in IR data books or data sheets is permissible only if reproduction is without alteration and is accompanied by all associated warranties, conditions, limitations, and notices. Reproduction of this information with alterations is an unfair and deceptive business practice. IR is not responsible or liable for such altered documentation. Information of third parties may be subject to additional restrictions.

Resale of IR products or serviced with statements different from or beyond the parameters stated by IR for that product or service voids all express and any implied warranties for the associated IR product or service and is an unfair and deceptive business practice. IR is not responsible or liable for any such statements.

IR products are not designed, intended, or authorized for use as components in systems intended for surgical implant into the body, or in other applications intended to support or sustain life, or in any other application in which the failure of the IR product could create a situation where personal injury or death may occur. Should Buyer purchase or use IR products for any such unintended or unauthorized application, Buyer shall indemnify and hold International Rectifier and its officers, employees, subsidiaries, affiliates, and distributors harmless against all claims, costs, damages, and expenses, and reasonable attorney fees arising out of, directly or indirectly, any claim of personal injury or death associated with such unintended or unauthorized use, even if such claim alleges that IR was negligent regarding the design or manufacture of the product.

Only products certified as military grade by the Defense Logistics Agency (DLA) of the US Department of Defense, are designed and manufactured to meet DLA military specifications required by certain military, aerospace or other applications. Buyers acknowledge and agree that any use of IR products not certified by DLA as military-grade, in applications requiring military grade products, is solely at the Buyer’s own risk and that they are solely responsible for compliance with all legal and regulatory requirements in connection with such use.

IR products are neither designed nor intended for use in automotive applications or environments unless the specific IR products are designated by IR as compliant with ISO/TS 16949 requirements and bear a part number including the designation “AU”. Buyers acknowledge and agree that, if they use any non-designated products in automotive applications, IR will not be responsible for any failure to meet such requirements.

For technical support, please contact IR’s Technical Assistance Center
<http://www.irf.com/technical-info/>

WORLD HEADQUARTERS:

101 N. Sepulveda Blvd., El Segundo, California 90245
Tel: (310) 252-7105