

POWER MOS IV™

APT8075AN	800V	11.5A	0.75 Ω
APT7575AN	750V	11.5A	0.75 Ω
APT8090AN	800V	10.5A	0.90 Ω
APT7590AN	750V	10.5A	0.90 Ω

N - CHANNEL ENHANCEMENT MODE HIGH VOLTAGE POWER MOSFETS

MAXIMUM RATINGS

All Ratings: $T_C = 25^\circ\text{C}$ unless otherwise specified.

Symbol	Parameter	APT				UNIT
		7575AN	8075AN	7590AN	8090AN	
V_{DSS}	Drain-Source Voltage	750	800	750	800	Volts
I_D	Continuous Drain Current	11.5		10.5		Amps
I_{DM}	Pulsed Drain Current ¹	46		42		Amps
V_{GS}	Gate-Source Voltage	±30				Volts
P_D	Total Power Dissipation @ $T_C = 25^\circ\text{C}$, Derate Above 25°C	230				Watts
T_J, T_{STG}	Operating and Storage Junction Temperature Range	- 55 to 150				°C

STATIC ELECTRICAL CHARACTERISTICS

Symbol	Characteristic / Test Conditions / Part Number	MIN	TYP	MAX	UNIT	
BV_{DSS}	Drain-Source Breakdown Voltage ($V_{GS} = 0V, I_D = 250 \mu\text{A}$)	APT8075AN / APT8090AN		800	Volts	
		APT7575AN / APT7590AN		750	Volts	
I_{DSS}	Zero Gate Voltage Drain Current ($V_{DS} = V_{DSS}, V_{GS} = 0V$) ($V_{DS} = 0.8 V_{DSS}, V_{GS} = 0V, T_C = 125^\circ\text{C}$)				250	μA
					1000	
I_{GSS}	Gate-Source Leakage Current ($V_{GS} = \pm 30V, V_{DS} = 0V$)				±100	nA
$I_D(ON)$	On State Drain Current ² ($V_{DS} > I_D(ON) \times R_{DS(ON)}$ Max, $V_{GS} = 10V$)	APT8075AN / APT7575AN		11.5	Amps	
		APT8090AN / APT7590AN		10.5	Amps	
$V_{GS(TH)}$	Gate Threshold Voltage ($V_{DS} = V_{GS}, I_D = 1mA$)	2		4	Volts	
$R_{DS(ON)}$	Static Drain-Source On-State Resistance ² ($V_{GS} = 10V, I_D = 0.5 I_D$ [Cont.])	APT8075AN / APT7575AN			0.75	Ohms
		APT8090AN / APT7590AN			0.90	Ohms

THERMAL CHARACTERISTICS

Symbol	Characteristic	MIN	TYP	MAX	UNIT
$R_{\theta JC}$	Junction to Case			0.53	°C/W
$R_{\theta JA}$	Junction to Ambient			30	°C/W
T_L	Max. Lead Temp. for Soldering Conditions: 0.063" from Case for 10 Sec.			300	°C

405 S.W. COLUMBIA STREET
BEND, OREGON 97702-1035
U.S.A.

PHONE . . . (503) 382-8028

FAX (503) 388-0364

DYNAMIC CHARACTERISTICS

APT8075/7575/8090/7590AN

Symbol	Characteristic	Test Conditions	MIN	TYP	MAX	UNIT
C_{iss}	Input Capacitance	$V_{GS} = 0V$ $V_{DS} = 25V$ $f = 1 MHz$		2410	2950	pF
C_{oss}	Output Capacitance			370	520	pF
C_{rss}	Reverse Transfer Capacitance			120	180	pF
Q_g	Total Gate Charge ³	$V_{GS} = 10V, I_D = I_D [Cont.]$ $V_{DD} = 0.5 V_{DSS}$		88	130	nC
Q_{gs}	Gate-Source Charge			8.9	13	nC
Q_{gd}	Gate-Drain ("Miller") Charge			44	67	nC
$t_d(on)$	Turn-on Delay Time	$V_{DD} = 0.5 V_{DSS}$ $I_D = I_D [Cont.], V_{GS} = 15V$ $R_G = 1.8$		13	27	ns
t_r	Rise Time			18	36	ns
$t_d(off)$	Turn-off Delay Time			62	94	ns
t_f	Fall Time			24	48	ns

SOURCE-DRAIN DIODE RATINGS AND CHARACTERISTICS

T-39-15

Symbol	Characteristic / Test Conditions / Part Number	MIN	TYP	MAX	UNIT
I_S	Continuous Source Current (Body Diode)	APT8075AN / APT7575AN		11.5	Amps
		APT8090AN / APT7590AN		10.5	Amps
I_{SM}	Pulsed Source Current ¹ (Body Diode)	APT8075AN / APT7575AN		46	Amps
		APT8090AN / APT7590AN		42	Amps
V_{SD}	Diode Forward Voltage ² ($V_{GS} = 0V, I_S = -I_D [Cont.]$)			1.3	Volts
t_{rr}	Reverse Recovery Time ($I_S = -I_D [Cont.], di_S/dt = 100A/\mu s$)	328	656	1300	ns
Q_{rr}	Reverse Recovery Charge	3.1	6.2	12	μC

SAFE OPERATING AREA CHARACTERISTICS

Symbol	Characteristic	Test Conditions / Part Number	MIN	TYP	MAX	UNIT
SOA1	Safe Operating Area	$V_{DS} = 0.4 V_{DSS}, I_{DS} = P_D / 0.4 V_{DSS}, t = 1 Sec.$	230			Watts
SOA2	Safe Operating Area	$I_{DS} = I_D [Cont.], V_{DS} = P_D / I_D [Cont.], t = 1 Sec.$	230			Watts
I_{LM}	Inductive Current Clamped	APT8075AN / APT7575AN	46			Amps
		APT8090AN / APT7590AN	42			Amps

1.) Repetitive Rating: Pulse width limited by maximum junction temperature. See Transient Thermal Impedance Curve. (Fig.1)

2.) Pulse Test: Pulse width < 380 μs Duty Cycle < 2%
3.) See MIL-STD-750 Method 3471

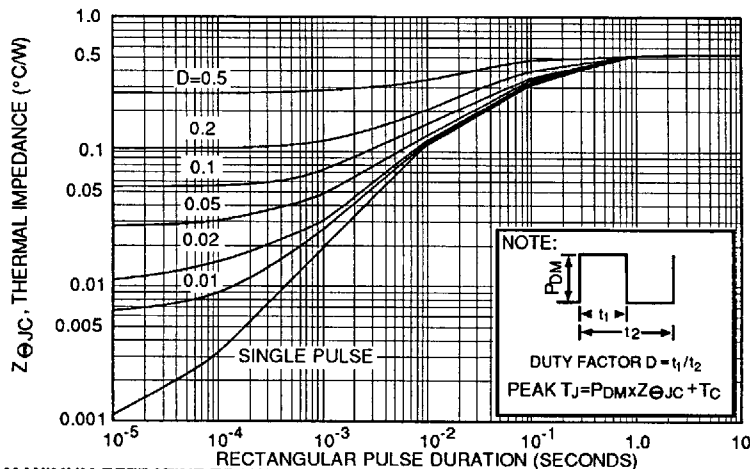

FIGURE 1, MAXIMUM EFFECTIVE TRANSIENT THERMAL IMPEDANCE, JUNCTION-TO-CASE vs PULSE DURATION

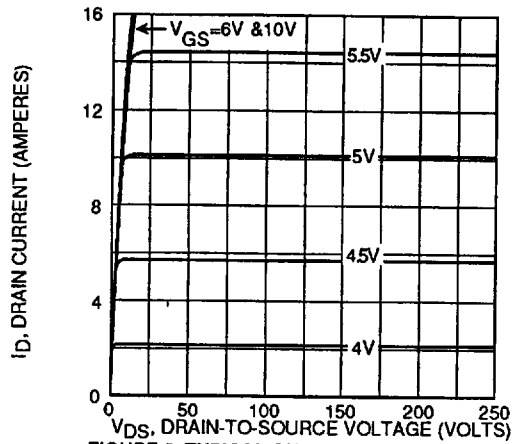

FIGURE 2, TYPICAL OUTPUT CHARACTERISTICS

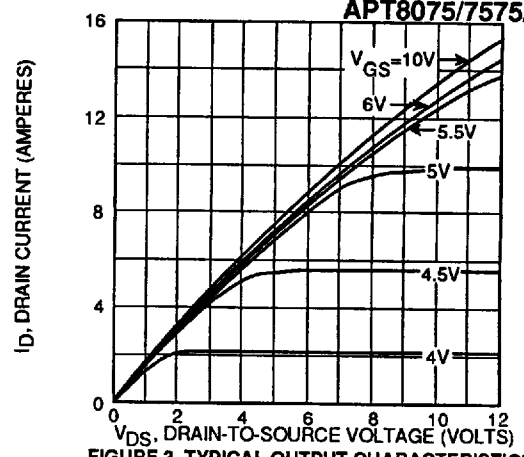

FIGURE 3, TYPICAL OUTPUT CHARACTERISTICS

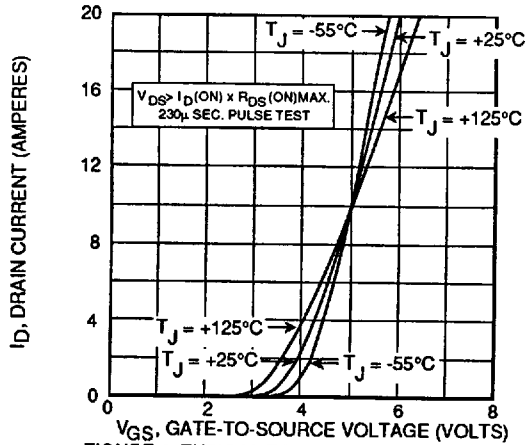

FIGURE 4, TYPICAL TRANSFER CHARACTERISTICS

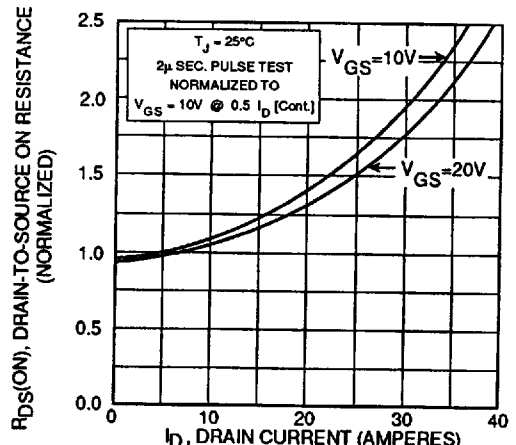

FIGURE 5, $R_{DS(ON)}$ vs DRAIN CURRENT

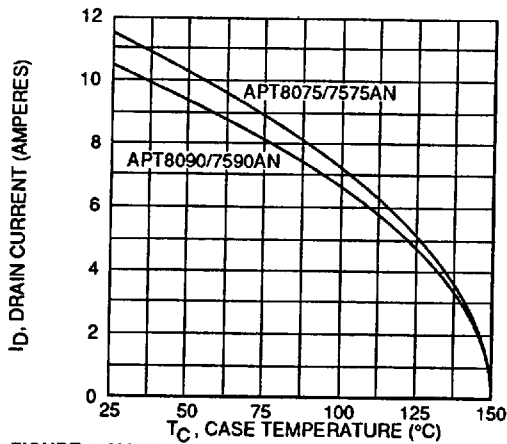

FIGURE 6, MAXIMUM DRAIN CURRENT vs CASE TEMPERATURE

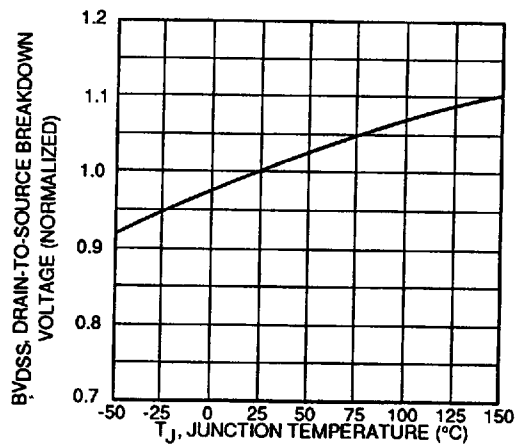

FIGURE 7, BREAKDOWN VOLTAGE vs TEMPERATURE

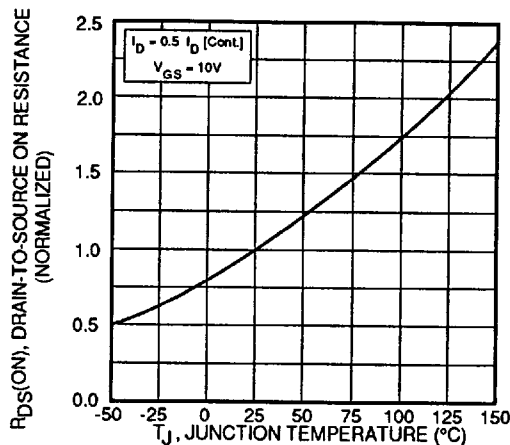

FIGURE 8, ON-RESISTANCE vs. TEMPERATURE

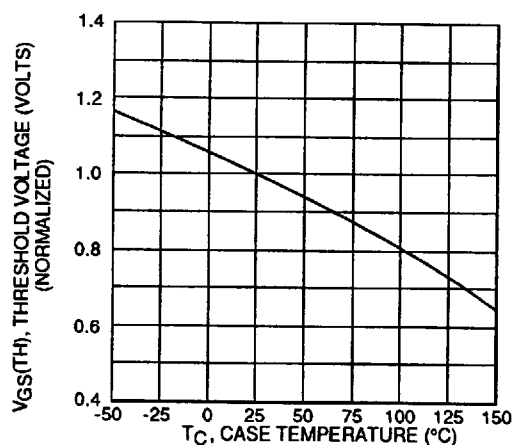

FIGURE 9, THRESHOLD VOLTAGE vs TEMPERATURE

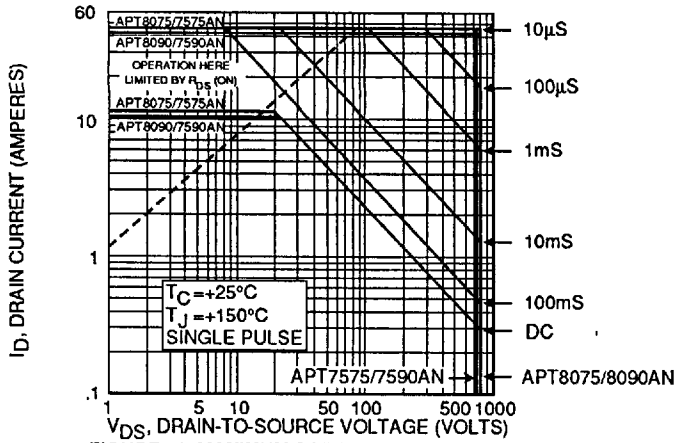

FIGURE 10, MAXIMUM SAFE OPERATING AREA

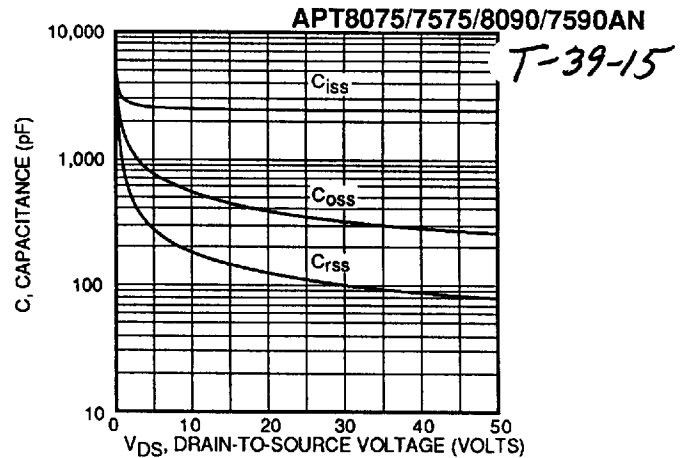

FIGURE 11, TYPICAL CAPACITANCE vs DRAIN-TO-SOURCE VOLTAGE

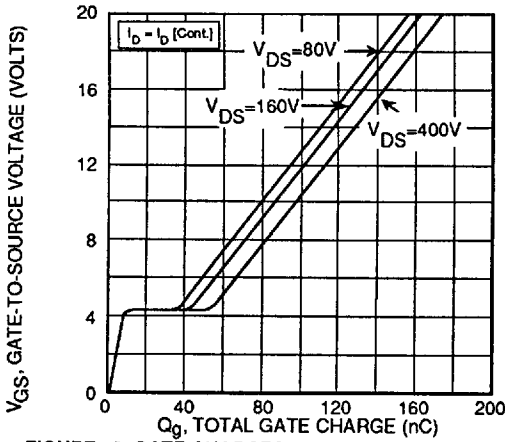

FIGURE 12, GATE CHARGES vs GATE-TO-SOURCE VOLTAGE

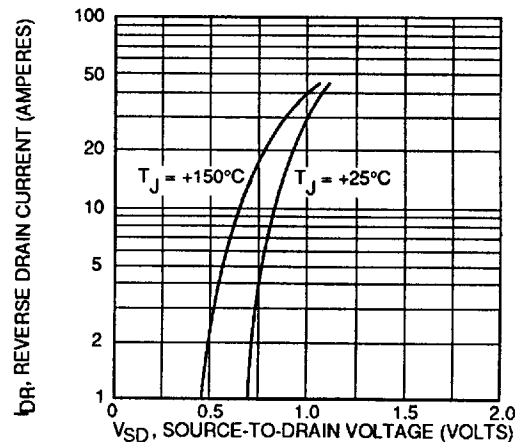
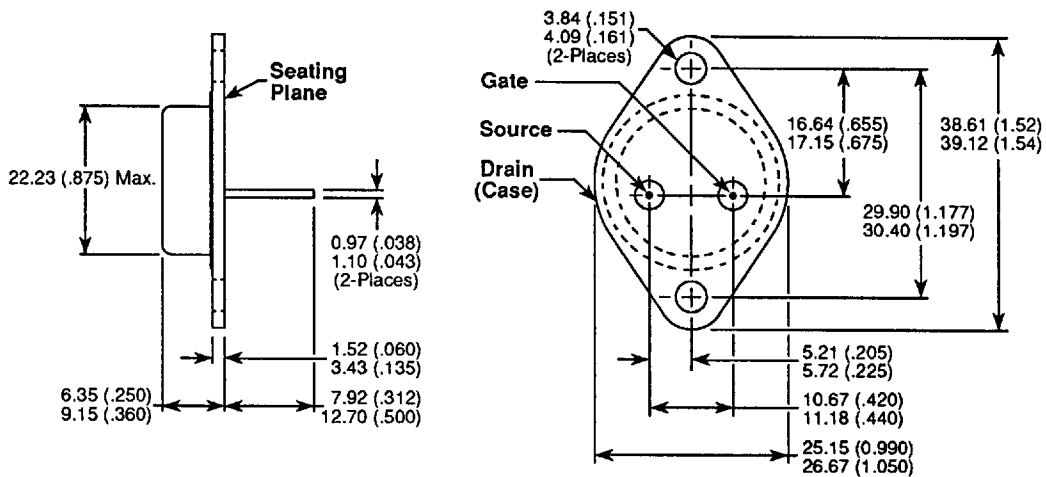

FIGURE 13, TYPICAL SOURCE-DRAIN DIODE FORWARD VOLTAGE

TO-3 Package Outline (TO-204AA)



Dimensions in Millimeters and (Inches)