

APT1004RBN	1000V	4.4A	4.00Ω
APT904RBN	900V	4.4A	4.00Ω
APT1004R2BN	1000V	4.0A	4.20Ω
APT904R2BN	900V	4.0A	4.20Ω

POWER MOSFET®

N-CHANNEL ENHANCEMENT MODE HIGH VOLTAGE POWER MOSFETS

MAXIMUM RATINGS

All Ratings: $T_C = 25^\circ\text{C}$ unless otherwise specified.

Symbol	Parameter	APT				UNIT
		904RBN	1004RBN	904R2BN	1004R2BN	
V_{DSS}	Drain-Source Voltage	900	1000	900	1000	Volts
I_D	Continuous Drain Current	4.4		4.0		Amps
I_{DM}	Pulsed Drain Current ^①	17.6		16		Amps
V_{GS}	Gate-Source Voltage	±30				Volts
P_D	Total Power Dissipation @ $T_C = 25^\circ\text{C}$, Derate Above 25°C	180				Watts
T_J, T_{STG}	Operating and Storage Junction Temperature Range	- 55 to 150				$^\circ\text{C}$

STATIC ELECTRICAL CHARACTERISTICS

Symbol	Characteristic / Test Conditions / Part Number	MIN	TYP	MAX	UNIT	
BV_{DSS}	Drain-Source Breakdown Voltage ($V_{GS} = 0V, I_D = 250 \mu\text{A}$)	APT1004RBN / APT1004R2BN	1000		Volts	
		APT904RBN / APT904R2BN	900		Volts	
I_{DSS}	Zero Gate Voltage Drain Current ($V_{DS} = V_{DSS}, V_{GS} = 0V$) ($V_{DS} = 0.8 V_{DSS}, V_{GS} = 0V, T_C = 125^\circ\text{C}$)			250	μA	
				1000		
I_{GSS}	Gate-Source Leakage Current ($V_{GS} = \pm 30V, V_{DS} = 0V$)			±100	nA	
$I_{D(ON)}$	On State Drain Current ^② ($V_{DS} > I_{D(ON)} \times R_{DS(ON)} \text{ Max}, V_{GS} = 10V$)	APT1004RBN / APT904RBN	4.4		Amps	
		APT1004R2BN / APT904R2BN	4.0		Amps	
$V_{GS(TH)}$	Gate Threshold Voltage ($V_{DS} = V_{GS}, I_D = 1\text{mA}$)	2		4	Volts	
$R_{DS(ON)}$	Static Drain-Source On-State Resistance ^② ($V_{GS} = 10V, I_D = 0.5 I_D \text{ [Cont.]}$)	APT1004RBN / APT904RBN			4.00	Ohms
		APT1004R2BN / APT904R2BN			4.20	Ohms

THERMAL CHARACTERISTICS

Symbol	Characteristic	MIN	TYP	MAX	UNIT
$R_{\theta JC}$	Junction to Case			0.68	$^\circ\text{C/W}$
$R_{\theta JA}$	Junction to Ambient			40	$^\circ\text{C/W}$
T_L	Max. Lead Temp. for Soldering Conditions: 0.063" from Case for 10 Sec.			300	$^\circ\text{C}$

CAUTION: These Devices are Sensitive to Electrostatic Discharge. Proper Handling Procedures Should Be Followed.

USA
405 S.W. Columbia Street
EUROPE

Avenue J.F. Kennedy Bât B4 Parc Cadéra Nord

Bend, Oregon 97702-1035

F-33700 Merignac - France

Phone: (503) 382-8028

Phone: (33) 56 34 34 71

FAX: (503) 388-0364

FAX: (33) 56 47 97 61

DYNAMIC CHARACTERISTICS

APT1004R/904R/1004R2/904R2BN

Symbol	Characteristic	Test Conditions	MIN	TYP	MAX	UNIT
C_{iss}	Input Capacitance	$V_{GS} = 0V$ $V_{DS} = 25V$ $f = 1\text{ MHz}$		805	950	pF
C_{oss}	Output Capacitance			115	160	pF
C_{rss}	Reverse Transfer Capacitance			37	60	pF
Q_g	Total Gate Charge ^③	$V_{GS} = 10V, I_D = I_D [Cont.]$ $V_{DD} = 0.5 V_{DSS}$		35	55	nC
Q_{gs}	Gate-Source Charge			4.3	6.5	nC
Q_{gd}	Gate-Drain ("Miller") Charge			18	27	nC
$t_d(on)$	Turn-on Delay Time	$V_{DD} = 0.5 V_{DSS}$ $I_D = I_D [Cont.], V_{GS} = 15V$ $R_G = 1.8\Omega$		12	23	ns
t_r	Rise Time			10	20	ns
$t_d(off)$	Turn-off Delay Time			33	50	ns
t_f	Fall Time			14	27	ns

SOURCE-DRAIN DIODE RATINGS AND CHARACTERISTICS

Symbol	Characteristic / Test Conditions / Part Number	MIN	TYP	MAX	UNIT
I_S	Continuous Source Current (Body Diode)	APT1004RBN / APT904RBN		4.4	Amps
		APT1004R2BN / APT904R2BN		4.0	Amps
I_{SM}	Pulsed Source Current ^① (Body Diode)	APT1004RBN / APT904RBN		17.6	Amps
		APT1004R2BN / APT904R2BN		16	Amps
V_{SD}	Diode Forward Voltage ^② ($V_{GS} = 0V, I_S = -I_D [Cont.]$)			1.3	Volts
t_{rr}	Reverse Recovery Time ($I_S = -I_D [Cont.], di_S/dt = 100A/\mu s$)	150	290	580	ns
Q_{rr}	Reverse Recovery Charge	0.8	1.65	3.3	μC

SAFE OPERATING AREA CHARACTERISTICS

Symbol	Characteristic	Test Conditions / Part Number	MIN	TYP	MAX	UNIT
SOA1	Safe Operating Area	$V_{DS} = 0.4 V_{DSS}, I_{DS} = P_D / 0.4 V_{DSS}, t = 1\text{ Sec.}$	180			Watts
SOA2	Safe Operating Area	$I_{DS} = I_D [Cont.], V_{DS} = P_D / I_D [Cont.], t = 1\text{ Sec.}$	180			Watts
I_{LM}	Inductive Current Clamped	APT1004RBN / APT904RBN	17.6			Amps
		APT1004R2BN / APT904R2BN	16			Amps

① Repetitive Rating: Pulse width limited by maximum junction temperature. See Transient Thermal Impedance Curve. (Fig.1)

② Pulse Test: Pulse width < 380 μs , Duty Cycle < 2%

③ See MIL-STD-750 Method 3471

APT Reserves the right to change, without notice, the specifications and information contained herein.

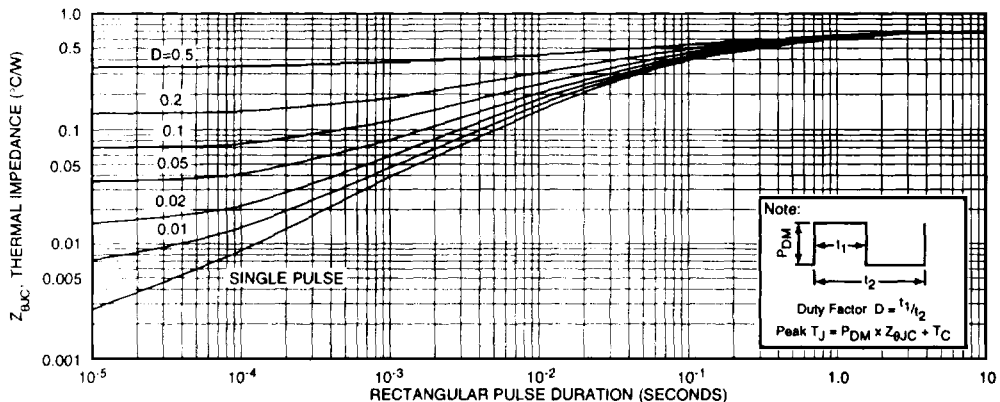

FIGURE 1, MAXIMUM EFFECTIVE TRANSIENT THERMAL IMPEDANCE, JUNCTION-TO-CASE vs PULSE DURATION

APT1004R/904R/1004R2/904R2BN

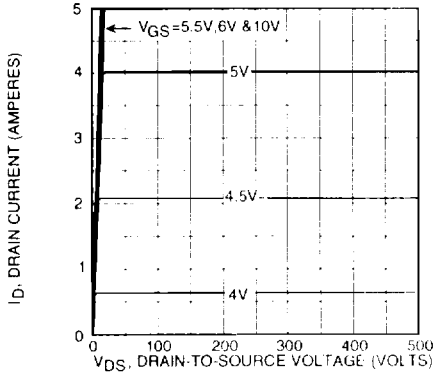

FIGURE 2. TYPICAL OUTPUT CHARACTERISTICS

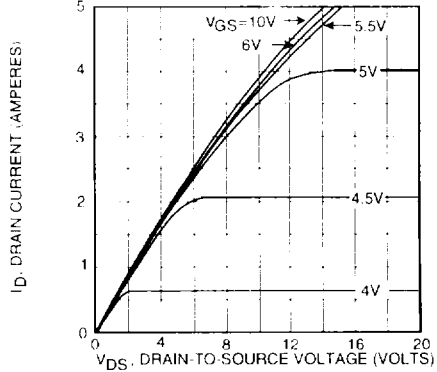

FIGURE 3. TYPICAL OUTPUT CHARACTERISTICS

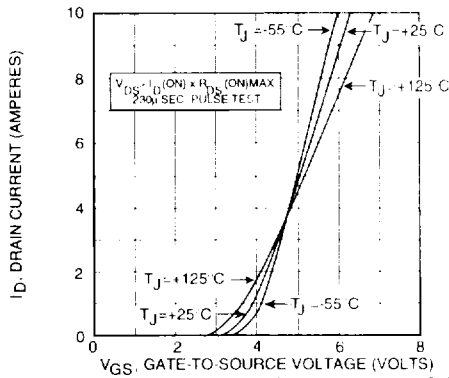

FIGURE 4. TYPICAL TRANSFER CHARACTERISTICS

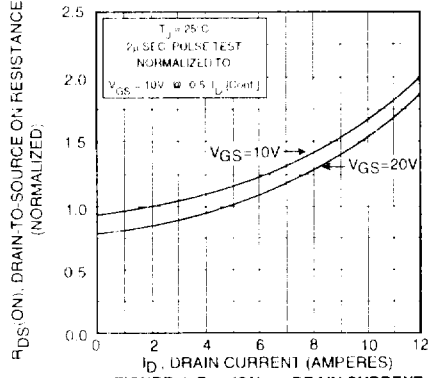

FIGURE 5. $R_{DS(ON)}$ vs DRAIN CURRENT

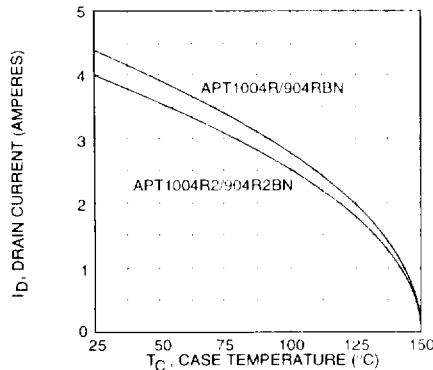

FIGURE 6. MAXIMUM DRAIN CURRENT vs CASE TEMPERATURE

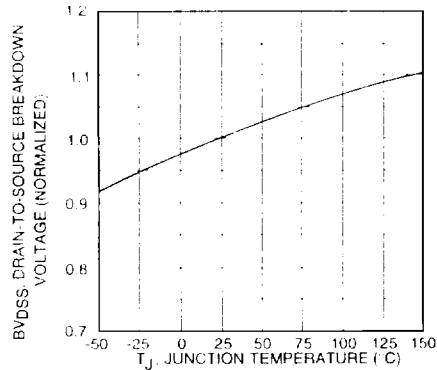

FIGURE 7. BREAKDOWN VOLTAGE vs TEMPERATURE

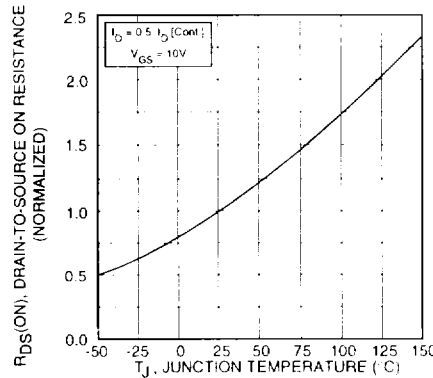

FIGURE 8. ON-RESISTANCE vs. TEMPERATURE

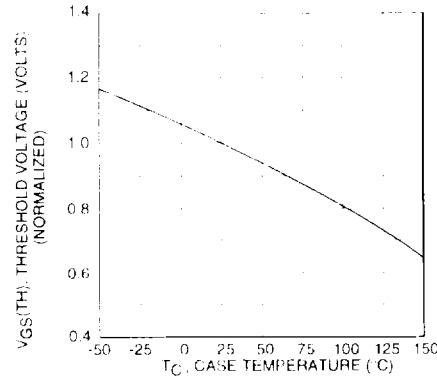

FIGURE 9. THRESHOLD VOLTAGE vs TEMPERATURE

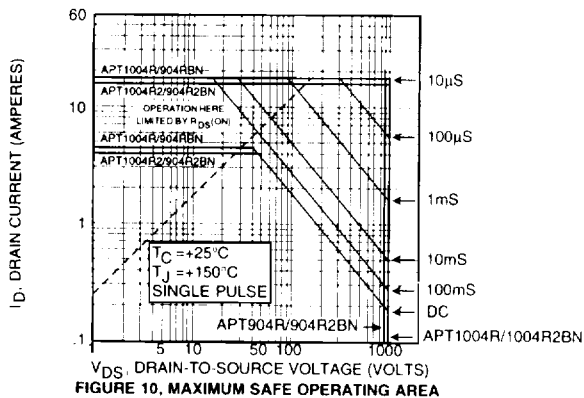

FIGURE 10. MAXIMUM SAFE OPERATING AREA

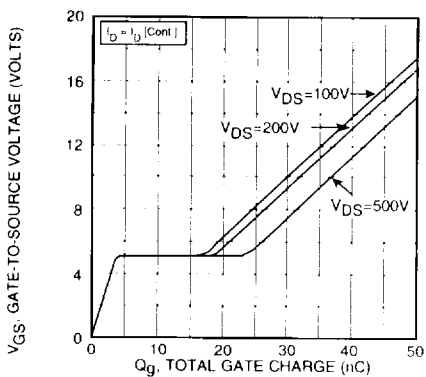

FIGURE 12. GATE CHARGES vs GATE-TO-SOURCE VOLTAGE

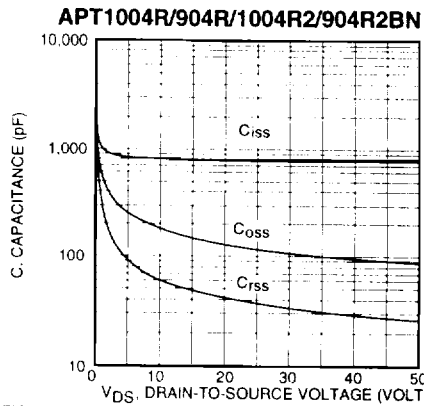

FIGURE 11. TYPICAL CAPACITANCE vs DRAIN-TO-SOURCE VOLTAGE

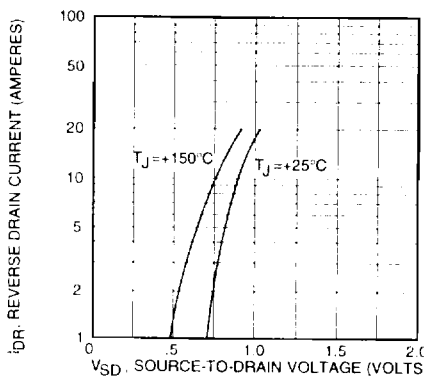
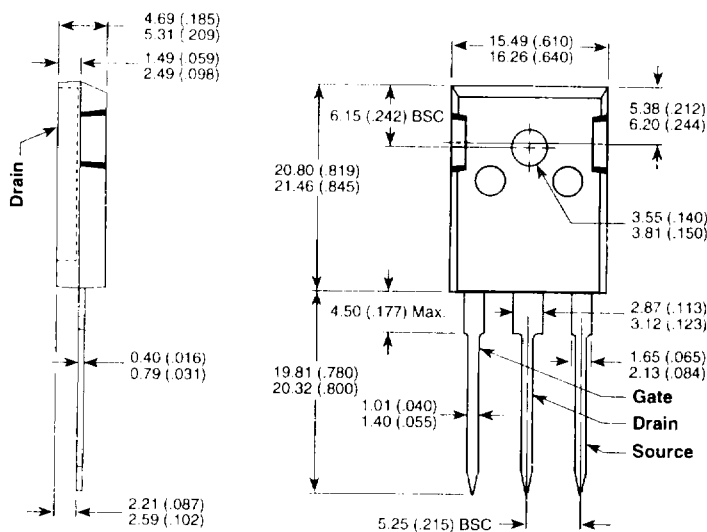

FIGURE 13. TYPICAL SOURCE-DRAIN DIODE FORWARD VOLTAGE

TO-247AD Package Outline



Dimensions in Millimeters and (Inches)
Page 193