

Features

- Low gate charge
- 100% avalanche tested
- Improved dv/dt capability
- RoHS compliant
- Halogen free package
- JEDEC Qualification

N-channel MOSFET

| | | |
|------------|-------|--------------|
| BV_{DSS} | I_D | $R_{DS(on)}$ |
| 600V | 16A | < 0.47Ω |

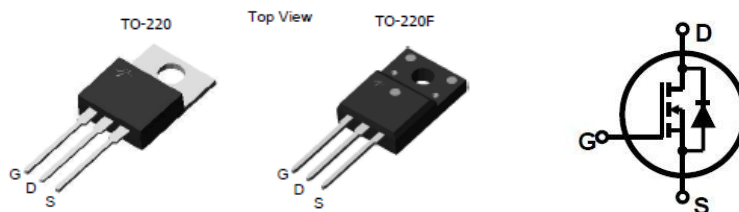

| Device | Package | Marking | Remark |
|--------------------------|------------------|--------------------------|--------------|
| TMP16N60A / TMPF16N60A | TO-220 / TO-220F | TMP16N60A / TMPF16N60A | RoHS |
| TMP16N60AG / TMPF16N60AG | TO-220 / TO-220F | TMP16N60AG / TMPF16N60AG | Halogen Free |

Absolute Maximum Ratings

| Parameter | Symbol | TMP16N60A(G) | TMPF16N60A(G) | Unit | |
|---|----------------|-----------------------------------|---------------|--------|------|
| Drain-Source Voltage | V_{DSS} | 600 | | V | |
| Gate-Source Voltage | V_{GS} | ±30 | | V | |
| Continuous Drain Current | I_D | $T_C = 25\text{ }^\circ\text{C}$ | 16 | 16 * | A |
| | | $T_C = 100\text{ }^\circ\text{C}$ | 9.97 | 9.97 * | A |
| Pulsed Drain Current (Note 1) | I_{DM} | 64 | 64 * | A | |
| Single Pulse Avalanche Energy (Note 2) | E_{AS} | 194 | | mJ | |
| Repetitive Avalanche Current (Note 1) | I_{AR} | 16 | | A | |
| Repetitive Avalanche Energy (Note 1) | E_{AR} | 29 | | mJ | |
| Power Dissipation | P_D | $T_C = 25\text{ }^\circ\text{C}$ | 290 | 48 | W |
| | | Derate above 25 °C | 2.32 | 0.38 | W/°C |
| Peak Diode Recovery dv/dt (Note 3) | dv/dt | 4.5 | | V/ns | |
| Operating Junction and Storage Temperature Range | T_J, T_{STG} | -55~150 | | °C | |
| Maximum lead temperature for soldering purposes, 1/8" from case for 5 seconds | T_L | 300 | | °C | |

* Limited only by maximum junction temperature

Thermal Characteristics

| Parameter | Symbol | TMP16N60A(G) | TMPF16N60A(G) | Unit |
|---|-----------------|--------------|---------------|------|
| Maximum Thermal resistance, Junction-to-Case | $R_{\theta JC}$ | 0.43 | 2.6 | °C/W |
| Maximum Thermal resistance, Junction-to-Ambient | $R_{\theta JA}$ | 62.5 | 62.5 | °C/W |

Electrical Characteristics : $T_C=25^\circ\text{C}$, unless otherwise noted

| Parameter | Symbol | Test condition | Min | Typ | Max | Units |
|-------------------------------------|------------|--|-----|-----|------|---------------|
| OFF | | | | | | |
| Drain-Source Breakdown Voltage | BV_{DSS} | $V_{GS} = 0\text{ V}, I_D = 250\ \mu\text{A}$ | 600 | -- | -- | V |
| Zero Gate Voltage Drain Current | I_{DSS} | $V_{DS} = 600\text{ V}, V_{GS} = 0\text{ V}$ | -- | -- | 1 | μA |
| | | $V_{DS} = 480\text{ V}, T_C = 125^\circ\text{C}$ | -- | -- | 10 | μA |
| Forward Gate-Source Leakage Current | I_{GSSF} | $V_{GS} = 30\text{ V}, V_{DS} = 0\text{ V}$ | -- | -- | 100 | nA |
| Reverse Gate-Source Leakage Current | I_{GSSR} | $V_{GS} = -30\text{ V}, V_{DS} = 0\text{ V}$ | -- | -- | -100 | nA |

ON

| | | | | | | |
|--|--------------|--|----|------|------|----------|
| Gate Threshold Voltage | $V_{GS(th)}$ | $V_{DS} = V_{GS}, I_D = 250\ \mu\text{A}$ | 3 | -- | 5 | V |
| Drain-Source On-Resistance | $R_{DS(on)}$ | $V_{GS} = 10\text{ V}, I_D = 8.0\text{ A}$ | -- | 0.38 | 0.47 | Ω |
| Forward Transconductance ^(Note 4) | g_{FS} | $V_{DS} = 30\text{ V}, I_D = 8.0\text{ A}$ | -- | 22 | -- | S |

DYNAMIC

| | | | | | | |
|------------------------------|-----------|--|----|------|----|----|
| Input Capacitance | C_{iss} | $V_{DS} = 25\text{ V}, V_{GS} = 0\text{ V},$ $f = 1.0\text{ MHz}$ | -- | 2840 | -- | pF |
| Output Capacitance | C_{oss} | | -- | 262 | -- | pF |
| Reverse Transfer Capacitance | C_{rss} | | -- | 10 | -- | pF |

SWITCHING

| | | | | | | |
|---|--------------|---|----|-----|----|----|
| Turn-On Delay Time ^(Note 4,5) | $t_{d(on)}$ | $V_{DD} = 300\text{ V}, I_D = 16\text{ A},$ $R_G = 25\ \Omega, V_{GS} = 10\text{ V}$ | -- | 61 | -- | ns |
| Turn-On Rise Time ^(Note 4,5) | t_r | | -- | 50 | -- | ns |
| Turn-Off Delay Time ^(Note 4,5) | $t_{d(off)}$ | | -- | 120 | -- | ns |
| Turn-Off Fall Time ^(Note 4,5) | t_f | | -- | 34 | -- | ns |
| Total Gate Charge ^(Note 4,5) | Q_g | $V_{DS} = 480\text{ V}, I_D = 16\text{ A},$ $V_{GS} = 10\text{ V}$ | -- | 44 | -- | nC |
| Gate-Source Charge ^(Note 4,5) | Q_{gs} | | -- | 13 | -- | nC |
| Gate-Drain Charge ^(Note 4,5) | Q_{gd} | | -- | 14 | -- | nC |

SOURCE DRAIN DIODE

| | | | | | | |
|---|----------|--|----|-----|-----|---------------|
| Maximum Continuous Drain-Source Diode Forward Current | I_S | ---- | -- | -- | 16 | A |
| Maximum Pulsed Drain-Source Diode Forward Current | I_{SM} | ---- | -- | -- | 64 | A |
| Drain-Source Diode Forward Voltage | V_{SD} | $V_{GS} = 0\text{ V}, I_S = 16\text{ A}$ | -- | -- | 1.5 | V |
| Reverse Recovery Time ^(Note 4) | t_{rr} | $V_{GS} = 0\text{ V}, I_S = 16\text{ A}$ | -- | 415 | -- | ns |
| Reverse Recovery Charge ^(Note 4) | Q_{rr} | $di_F / dt = 100\text{ A}/\mu\text{s}$ | -- | 5.6 | -- | μC |

Note :

1. Repeated rating : Pulse width limited by safe operating area
2. $L=1.39\text{mH}, I_{AS} = 16\text{ A}, V_{DD} = 50\text{ V}, R_G = 25\ \Omega,$ Starting $T_J = 25^\circ\text{C}$
3. $I_{SD} \leq 16\text{ A}, di/dt \leq 200\text{ A}/\mu\text{s}, V_{DD} \leq BV_{DS},$ Starting $T_J = 25^\circ\text{C}$
4. Pulse Test : Pulse width $\leq 300\ \mu\text{s},$ Duty Cycle $\leq 2\%$
5. Essentially Independent of Operating Temperature Typical Characteristics

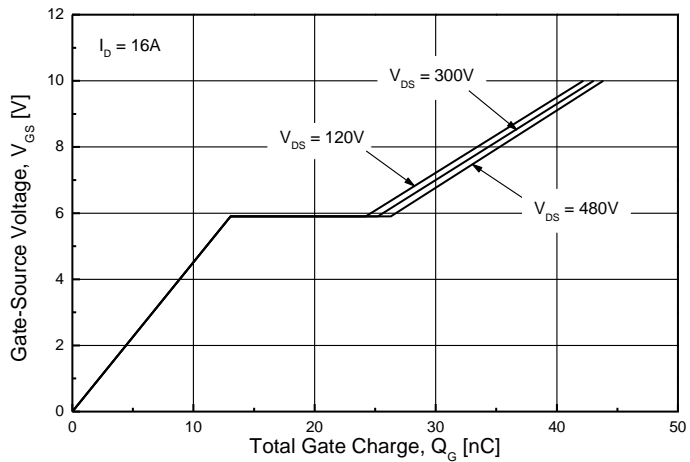
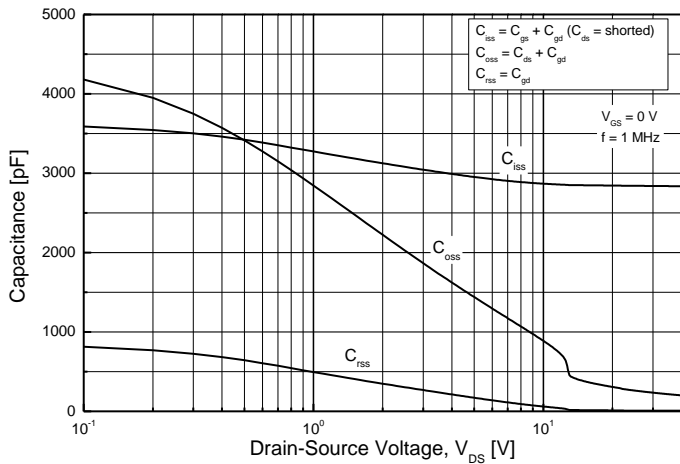
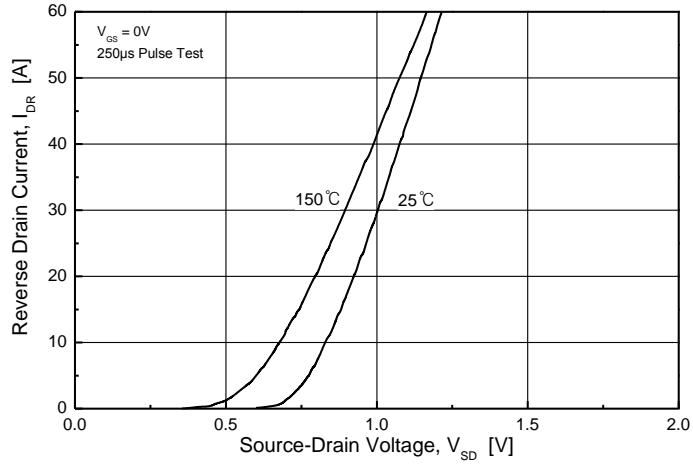
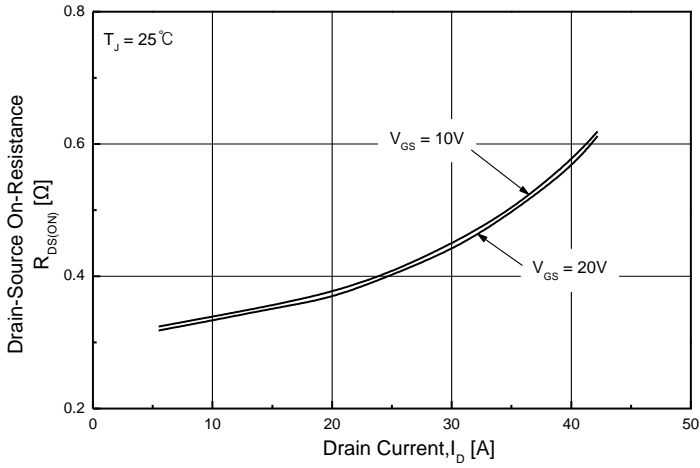
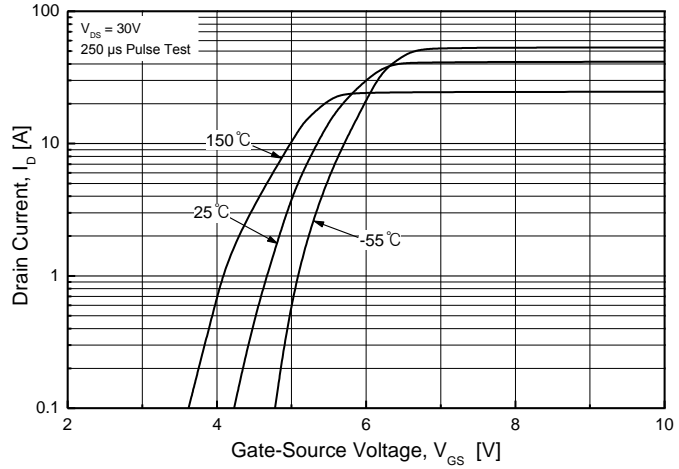
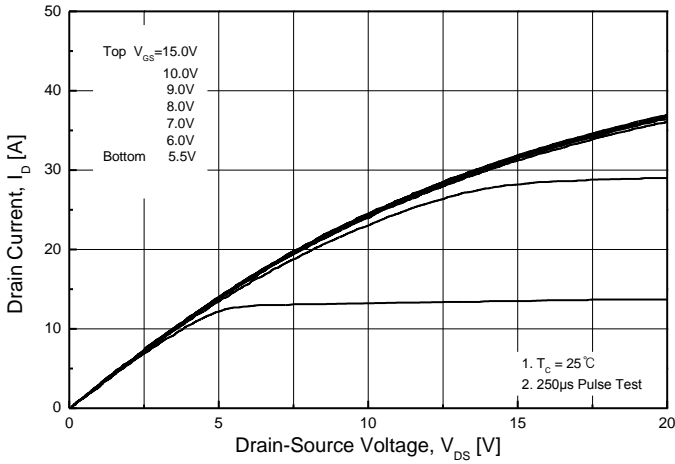

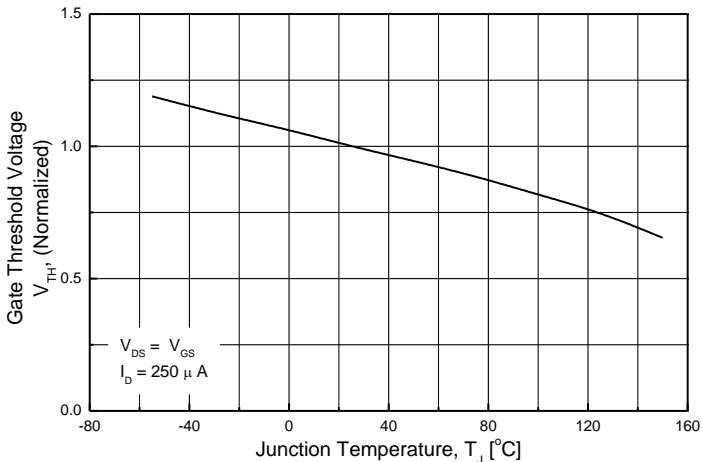
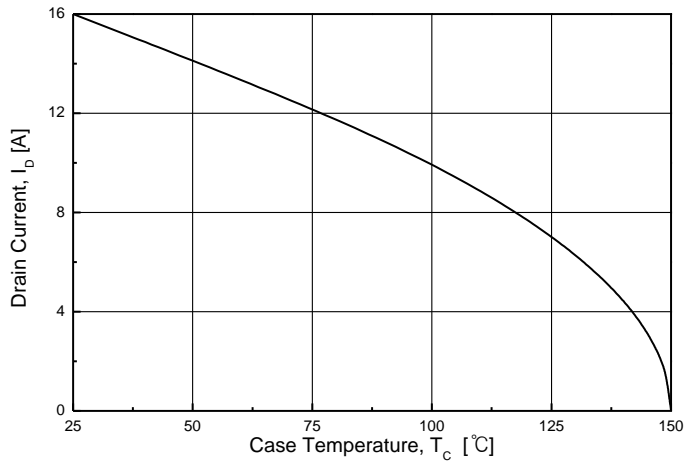
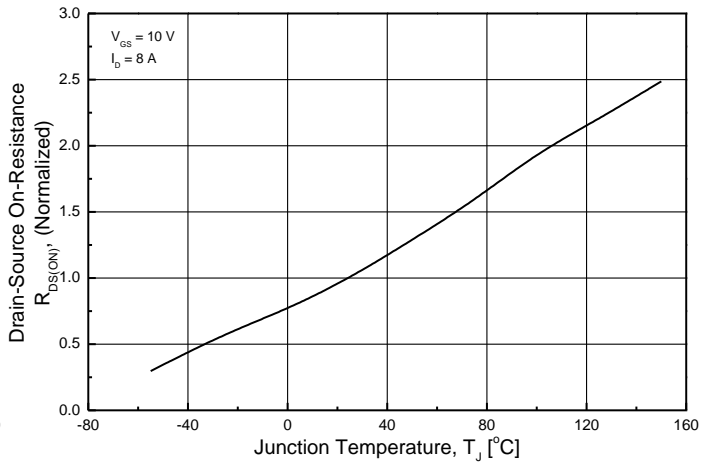
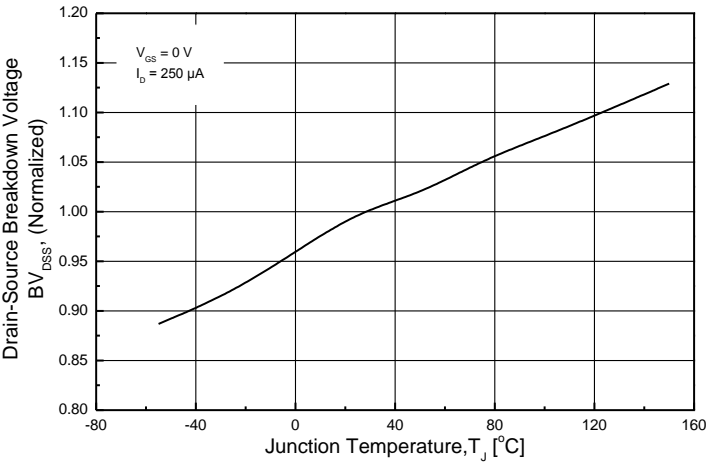

TMP16N60A(G)

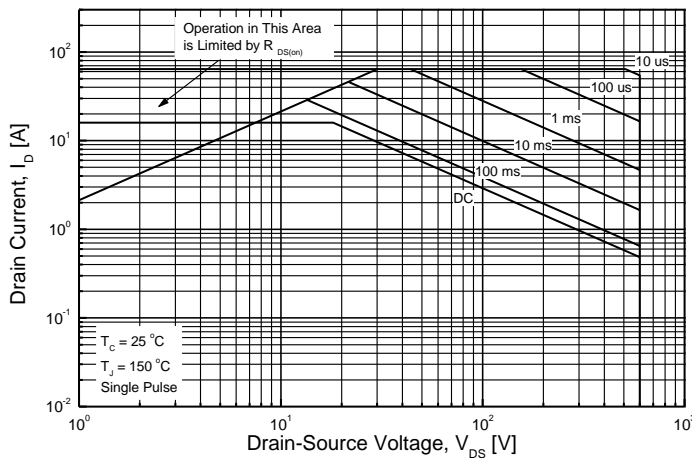

TMPF16N60A(G)

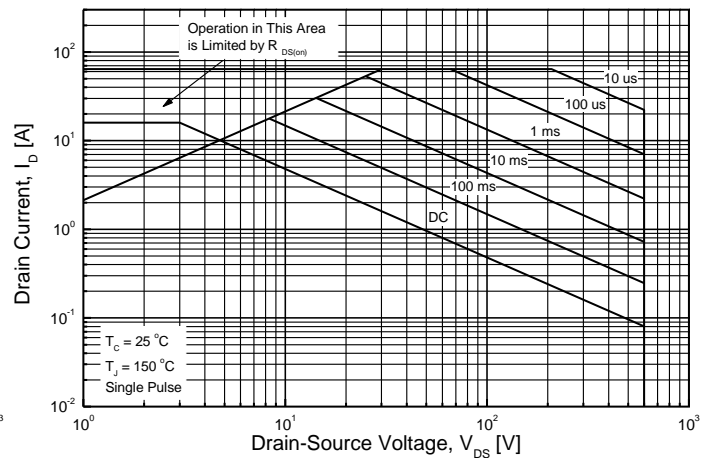

TMP16N60A(G)

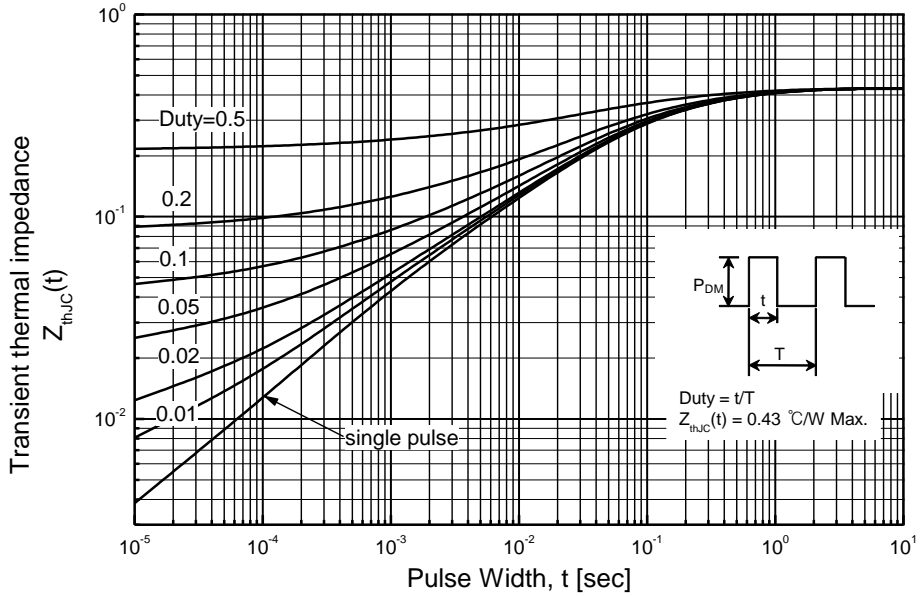

TMPF16N60A(G)

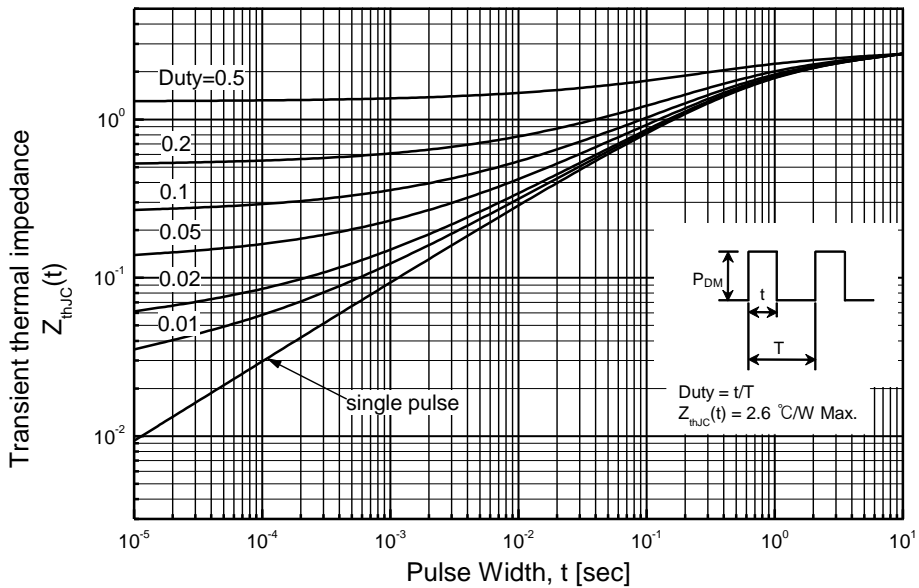

TO-220AB-3L MECHANICAL DATA

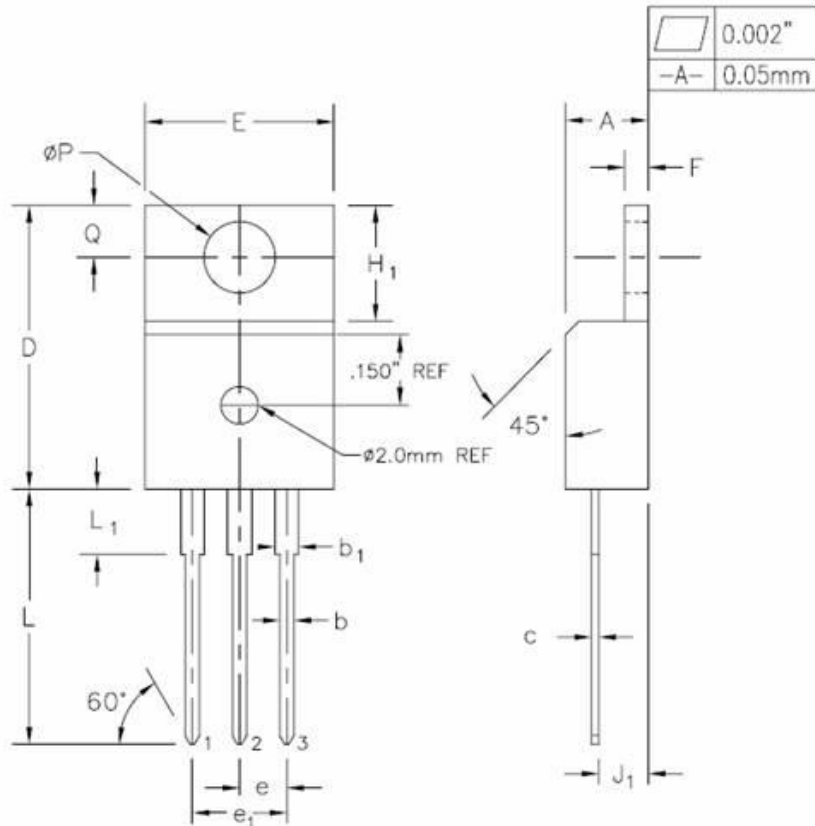

| SYMBOL | INCHES | | MILLIMETERS | | NOTES |
|----------------|------------|-------|-------------|-------|-------|
| | MIN. | MAX. | MIN. | MAX. | |
| A | 0.170 | 0.180 | 4.32 | 4.57 | |
| b | 0.028 | 0.036 | 0.71 | 0.91 | |
| b ₁ | 0.045 | 0.055 | 1.15 | 1.39 | |
| c | 0.014 | 0.021 | 0.36 | 0.53 | |
| D | 0.590 | 0.610 | 14.99 | 15.49 | |
| E | 0.395 | 0.410 | 10.04 | 10.41 | |
| e | 0.100 TYP. | | 2.54 TYP. | | |
| e ₁ | 0.200 BSC | | 5.08 BSC | | |
| F | 0.048 | 0.054 | 1.22 | 1.37 | |
| H ₁ | 0.235 | 0.255 | 5.97 | 6.47 | |
| J ₁ | 0.100 | 0.110 | 2.54 | 2.79 | |
| L | 0.530 | 0.550 | 13.47 | 13.97 | |
| L ₁ | 0.130 | 0.150 | 3.31 | 3.81 | 2 |
| ∅P | 0.149 | 0.153 | 3.79 | 3.88 | |
| Q | 0.102 | 0.112 | 2.60 | 2.84 | |

TO-220F-3L MECHANICAL DATA

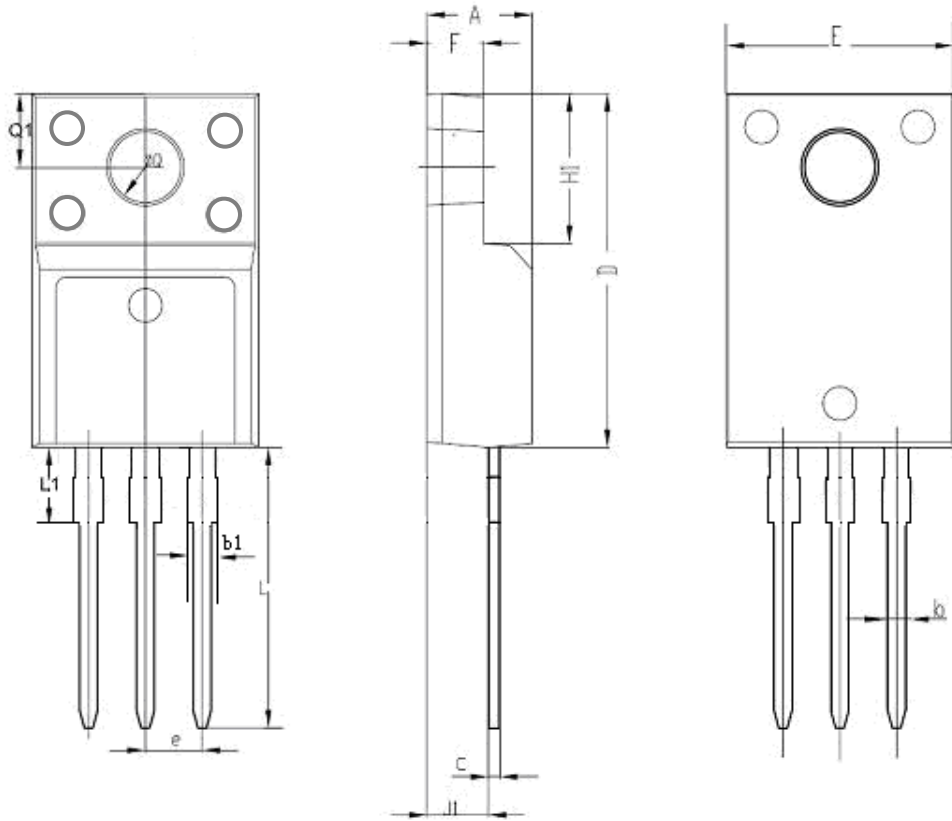

| SYMBOL | INCHES | | MILLIMETERS | | NOTES |
|--------|------------|-------|-------------|-------|-------|
| | MIN | MAX | MIN | MAX | |
| A | 0.178 | 0.194 | 4.53 | 4.93 | |
| b | 0.028 | 0.036 | 0.71 | 0.91 | |
| C | 0.018 | 0.024 | 0.45 | 0.60 | |
| D | 0.617 | 0.633 | 15.67 | 16.07 | |
| E | 0.392 | 0.408 | 9.96 | 10.36 | |
| e | 0.100 TYP. | | 2.54TYP. | | |
| H1 | 0.256 | 0.272 | 6.50 | 6.90 | |
| J1 | 0.101 | 0.117 | 2.56 | 2.96 | |
| L | 0.503 | 0.519 | 12.78 | 13.18 | |
| φQ | 0.117 | 0.133 | 2.98 | 3.38 | |
| b1 | 0.045 | 0.055 | 1.15 | 1.39 | |
| L1 | 0.114 | 0.130 | 2.9 | 3.3 | |
| Q1 | 0.122 | 0.138 | 3.10 | 3.50 | |
| F | 0.092 | 0.108 | 2.34 | 2.74 | |