

Surface Mount P-Channel Enhancement Mode Power MOSFET

(Pb) Lead(Pb)-Free

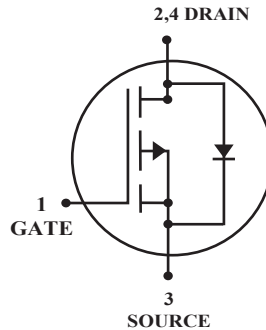

DRAIN CURRENT
-6.0 AMPERES
DRAIN SOURCE VOLTAGE
-30 VOLTAGE

Features:

- * Super high dense cell design for low $R_{DS(ON)}$
 $R_{DS(ON)} < 50m\Omega @ V_{GS} = -10V$
- * Simple Drive Requirement
- * Lower On-Resistance
- * Fast Switching

1. GATE
2. DRAIN
3. SOURCE
4. DRAIN

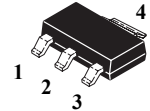

SOT-223

Maximum Ratings ($T_A=25^\circ\text{C}$ Unless Otherwise Specified)

Rating	Symbol	Value	Unit
Drain-Source Voltage	V_{DS}	-30	V
Gate-Source Voltage	V_{GS}	± 25	V
Continuous Drain Current ³ , $V_{GS}@10V(T_A=25^\circ\text{C})$ $, V_{GS}@10V(T_A=70^\circ\text{C})$	I_D	-6.0 -4.8	A
Pulsed Drain Current ¹	I_{DM}	-20	A
Total Power Dissipation ($T_A=25^\circ\text{C}$)	P_D	2.7	W
Maximum Junction-ambient ³	$R_{\theta JA}$	45	$^\circ\text{C/W}$
Operating Junction and Storage Temperature Range	T_J, T_{stg}	-55 ~ +150	$^\circ\text{C}$

Device Marking

WTN9435 = 9435

Electrical Characteristics ($T_A = 25^\circ\text{C}$ Unless otherwise noted)

Characteristic	Symbol	Min	Typ	Max	Unit
----------------	--------	-----	-----	-----	------

Static

Drain-Source Breakdown Voltage $V_{GS} = 0, I_D = -250\mu\text{A}$	$V_{(BR)DSS}$	-30	-	-	V
Gate-Source Threshold Voltage $V_{DS} = V_{GS}, I_D = -250\mu\text{A}$	$V_{GS(Th)}$	-1.0	-	-3.0	V
Gate-Source Leakage Current $V_{GS} = \pm 25\text{V}$	I_{GSS}	-	-	± 100	nA
Drain-Source Leakage Current($T_j=25^\circ\text{C}$) $V_{DS} = -30\text{A}, V_{GS} = 0$	I_{DSS}	-	-	-1	μA
Drain-Source Leakage Current($T_j=70^\circ\text{C}$) $V_{DS} = -24\text{V}, V_{GS} = 0$		-	-	-25	
Drain-Source On-Resistance ² $V_{GS} = -10\text{A}, I_D = -5.3\text{A}$ $V_{DS} = -4.5\text{A}, I_D = -4.2\text{A}$	$R_{DS(ON)}$	-	-	50 100	$\text{m}\Omega$
Forward Transconductance $V_{DS} = -10\text{A}, I_D = -5.3\text{A}$	g_{fs}	-	10	-	S

Dynamic

Input Capacitance $V_{GS} = 0\text{V}, V_{DS} = -15\text{V}, f = 1.0\text{MHz}$	C_{iss}	-	507	912	pF
Output Capacitance $V_{GS} = 0\text{V}, V_{DS} = -15\text{V}, f = 1.0\text{MHz}$	C_{oss}	-	222	-	
Reverse Transfer Capacitance $V_{GS} = 0\text{V}, V_{DS} = -15\text{V}, f = 1.0\text{MHz}$	C_{rss}	-	158	-	

Switching

Turn-on Delay Time ² $V_{DS}=-15V, V_{GS}=-10V, I_D=1A, R_D=15\Omega, R_G=6\Omega$	$t_{d(on)}$	-	11	-	ns
Rise Time $V_{DS}=-15V, V_{GS}=-10V, I_D=1A, R_D=15\Omega, R_G=6\Omega$	t_r	-	8	-	
Turn-off Delay Time $V_{DS}=-15V, V_{GS}=-10V, I_D=1A, R_D=15\Omega, R_G=6\Omega$	$t_{d(off)}$	-	25	-	
Fall Time $V_{DS}=-15V, V_{GS}=-10V, I_D=1A, R_D=15\Omega, R_G=6\Omega$	t_f	-	17	-	
Total Gate Charge ² $V_{DS}=-24V, V_{GS}=-4.5V, I_D=-5.3A$	Q_g	-	9.2	16	nC
Gate-Source Charge $V_{DS}=-24V, V_{GS}=-4.5V, I_D=-5.3A$	Q_{gs}	-	2.8	-	
Gate-Drain Change $V_{DS}=-24V, V_{GS}=-4.5V, I_D=-5.3A$	Q_{gd}	-	5.2	-	

Source-Drain Diode Characteristics

Forward On Voltage ² $V_{GS}=0V, I_S=-2.3A$	V_{SD}	-	-	-1.2	V
Reverse Recovery Time $V_{GS}=0V, I_S=-5.3A, di/dt=100A/\mu s$	T_{rr}	-	29	-	ns
Reverse Recovery Charge $V_{GS}=0V, I_S=-5.3A, di/dt=100A/\mu s$	Q_{rr}	-	20	-	nC

Note:

1. Pulse width limited by max, junction temperature.
2. Pulse width $\leq 300\mu s$, duty cycle $\leq 2\%$.
3. Surface mounted on 1 in² copper pad of FR4 board; 120°C/W when mounted on Min, copper pad.

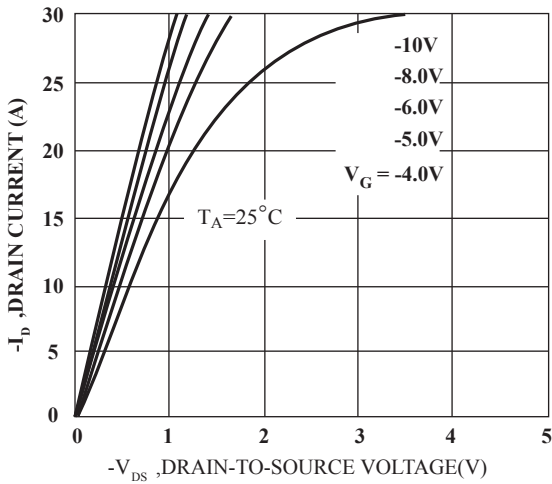

FIG.1 Typical Output Characteristics

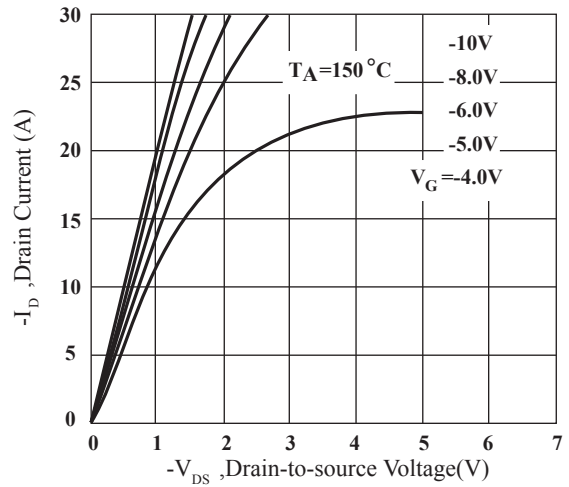

Fig.2 Typical Output Characteristics

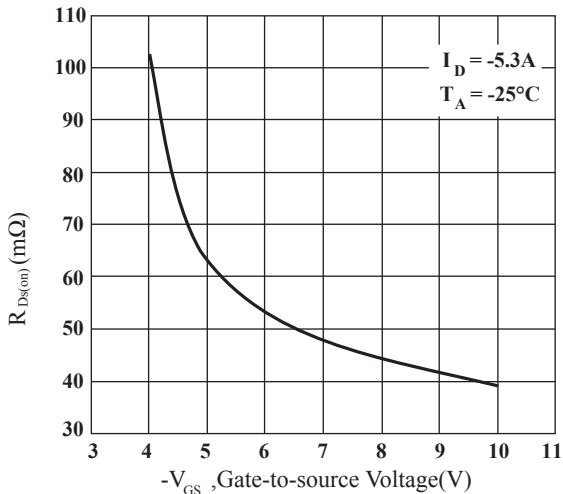

FIG.3 On-Resistance v.s. Gate Voltage

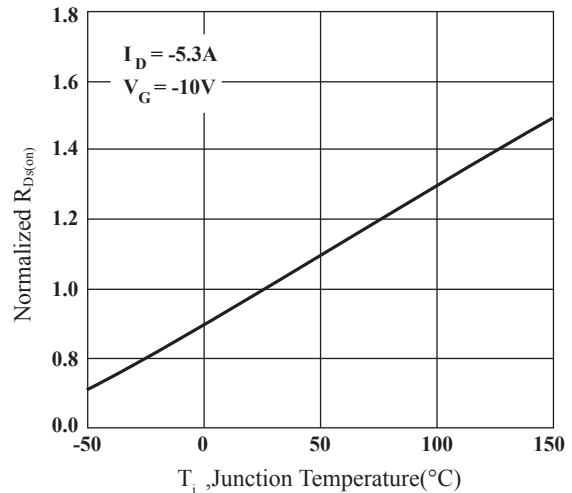

Fig.4 Normalized OnResistance

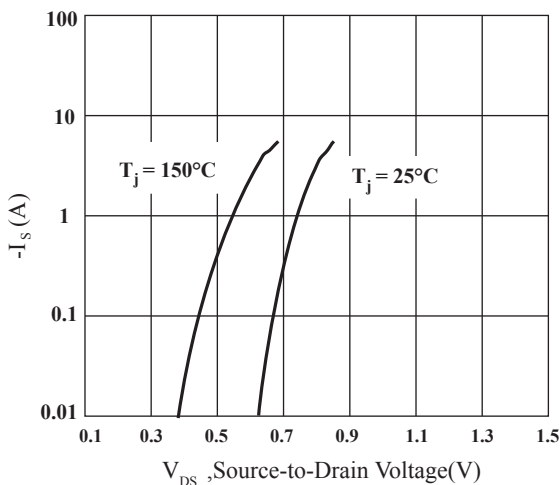

Fig.5 Forward Characteristics of Reverse Diode

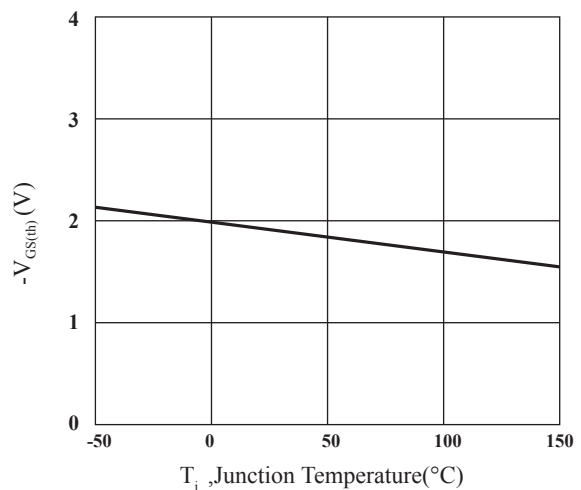

Fig.6 Gate Threshold Voltage v.s. Junction Temperature

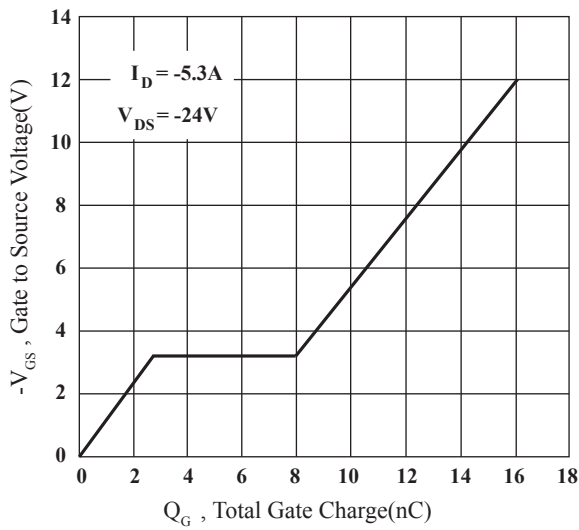

Fig 7. Gate Charge Characteristics

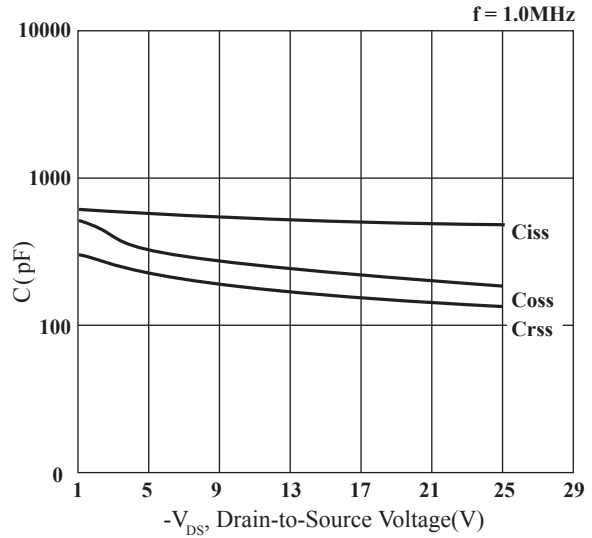

Fig 8. Typical Capacitance Characteristics

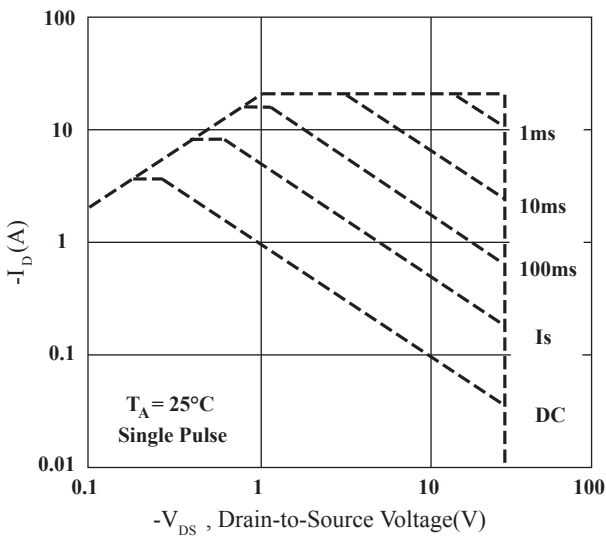

Fig 9. Maximum Safe Operation Area

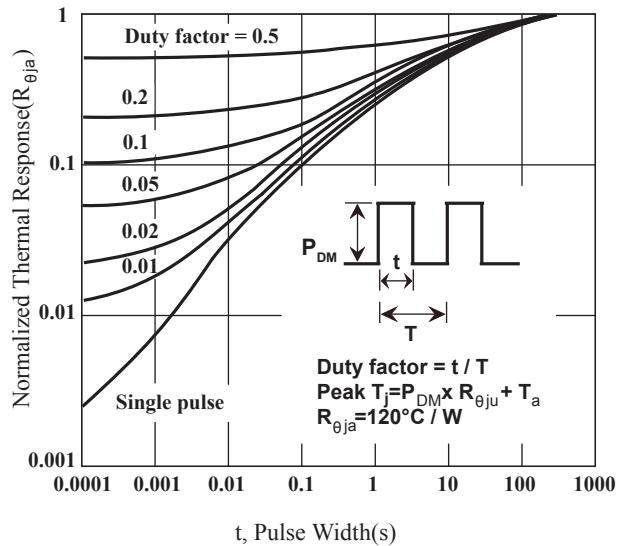

Fig 10. Effective Transient Thermal Impedance

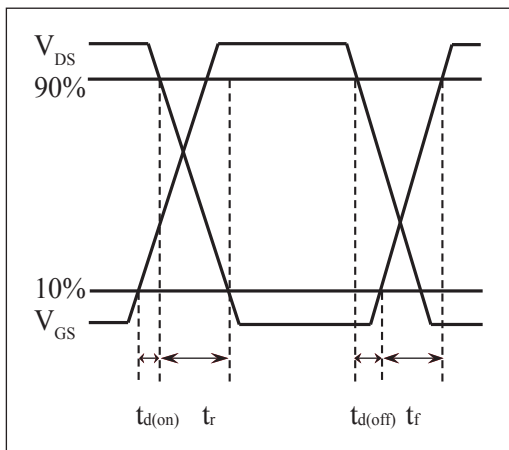

Fig 11. Switching Time Circuit

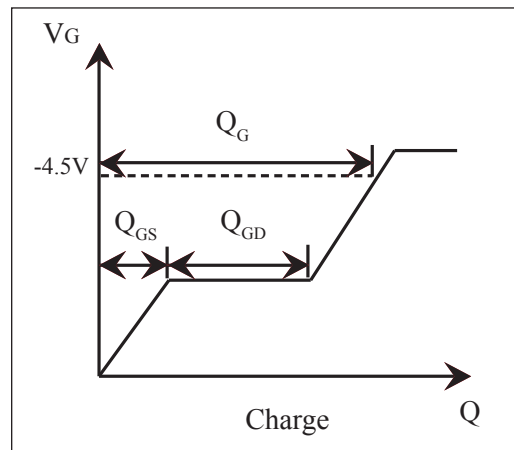
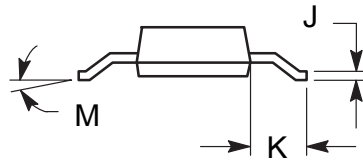
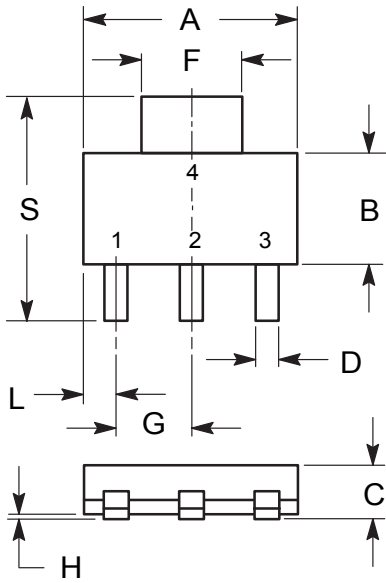

Fig.12 Gate Charge Waveform

SOT-223 Outline Dimensions

unit:mm



DIM	MILLIMETERS	
	MIN	MAX
A	6.30	6.70
B	3.30	3.70
C	1.50	1.75
D	0.60	0.89
F	2.90	3.20
G	2.20	2.40
H	0.020	0.100
J	0.24	0.35
K	1.50	2.00
L	0.85	1.05
M	0°	10°
S	6.70	7.30