

Surface Mount P-Channel Enhancement Mode MOSFET

(Pb) Lead(Pb)-Free

Features:

- * Super high dense
- * Cell design for low $R_{DS(ON)}$
- * $R_{DS(ON)} < 10\text{m}\Omega @ V_{GS} = -10\text{V}$
- * $R_{DS(ON)} < 13\text{m}\Omega @ V_{GS} = -4.5\text{V}$
- * Simple Drive Requirement
- * Lower On-resistance
- * Fast Switching

Description:

The WTK6679 provide the designer with the best combination of fast switching, ruggedized device design, low on-resistance and cost-effectiveness.

The SOP-8 package is universally preferred for all commercial-industrial surface mount applications and suited for low voltage applications such as DC/DC converters.

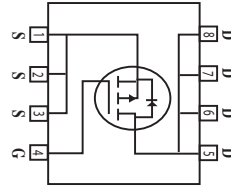

DRAIN CURRENT
-14 AMPERES
DRAIN SOURCE VOLTAGE
-30 VOLTAGE

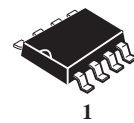

SOP-8

Maximum Ratings ($T_A = 25^\circ\text{C}$ Unless Otherwise Specified)

Rating	Symbol	Value	Unit
Drain-Source Voltage	V_{DS}	-30	V
Gate-Source Voltage	V_{GS}	± 25	V
Continuous Drain Current ($T_A = 25^\circ\text{C}$) ($T_A = 70^\circ\text{C}$)	I_D	-14 -8.9	A
Pulsed Drain Current ⁽¹⁾	I_{DM}	-50	A
Power Dissipation ($T_A = 25^\circ\text{C}$)	P_D	2.5	W
Maximax Junction-to-Ambient	$R_{\theta JA}$	50	$^\circ\text{C}/\text{W}$
Operating Junction Temperature Range	T_J	+150	$^\circ\text{C}$
Storage Temperature Range	T_{stg}	-55 to +150	$^\circ\text{C}$

Device Marking

WTK6679=6679SC

Electrical Characteristics (T_A=25°C Unless otherwise noted)

Characteristic	Symbol	Min	Typ	Max	Unit
----------------	--------	-----	-----	-----	------

Static

Drain-Source Breakdown Voltage V _{GS} =0V, I _D =-250 μA	V _{(BR)DSS}	-30	-	-	V
Gate-Source Threshold Voltage V _{DS} =V _{GS} , I _D =-250 μA	V _{GS(th)}	-1.0	-	-3.0	V
Gate-Source Leakage Current V _{DS} =0V, V _{GS} =±25V	I _{GSS}	-	-	±100	nA
Zero Gate Voltage Drain Current V _{DS} =-30V, V _{GS} =0V V _{DS} =-24V, V _{GS} =0V	I _{DSS}	-	-	-1 -25	μA
Drain-Source On-Resistance V _{GS} =-10V, I _D =-14A V _{GS} =-4.5V, I _D =-11A	R _{DS(on)}	- -	- -	10 13	mΩ
Forward Transconductance V _{DS} =-10V, I _D =-14A	g _{fs}	-	26	-	S

Dynamic

Input Capacitance V _{DS} =-25V, V _{GS} =0V, f=1MHZ	C _{iss}	-	2860	4580	pF
Output Capacitance V _{DS} =-25V, V _{GS} =0V, f=1MHZ	C _{oss}	-	950	-	
Reverse Transfer Capacitance V _{DS} =-25V, V _{GS} =0V, f=1MHZ	C _{rss}	-	640	-	

Switching

Turn-On Delay Time ⁽²⁾ V _{DS} = -15V, I _D = -1A, V _{GS} = -10V, R _G = 3.3Ω, R _D = 15Ω	t _{d(on)}	-	13	-	nS
Rise Time V _{DS} = -15V, I _D = -1A, V _{GS} = -10V, R _G = 3.3Ω, R _D = 15Ω	t _r	-	11	-	nS
Turn-Off Time V _{DS} = -15V, I _D = -1A, V _{GS} = -10V, R _G = 3.3Ω, R _D = 15Ω	t _{d(off)}	-	58	-	nS
Fall Time V _{DS} = -15V, I _D = -1A, V _{GS} = -10V, R _G = 3.3Ω, R _D = 15Ω	t _f	-	43	-	nS
Total Gate Charge ⁽²⁾ V _{DS} =-24V, I _D =-14A, V _{GS} =-4.5V	Q _g	-	37	60	nC
Gate-Source Charge V _{DS} =-24V, I _D =-14A, V _{GS} =-4.5V	Q _{gs}	-	3	-	nC
Gate-Drain Charge V _{DS} =-24V, I _D =-14A, V _{GS} =-4.5V	Q _{gd}	-	25	-	nC
Forward On Voltage ⁽²⁾ V _{GS} =0V, I _S =-2A	V _{SD}	-	-	-1.2	V
Reverse Recovery Time ⁽²⁾ V _{GS} =0V, I _S =-14A, dl/dt=100A/μs	T _{rr}	-	48	-	nS
Reverse Recovery Charge V _{GS} =0V, I _S =-14A, dl/dt=100A/μs	Q _{rr}	-	46	-	nC

Notes: 1. Pulse width limited by Max. junction temperature.

2. Pulse width ≤ 300us, duty cycle ≤ 2%.

3. Surface mounted on 1 in² copper pad of FR4 board; 125°C/W when mounted on Min. copper pad.

Characteristics Curve

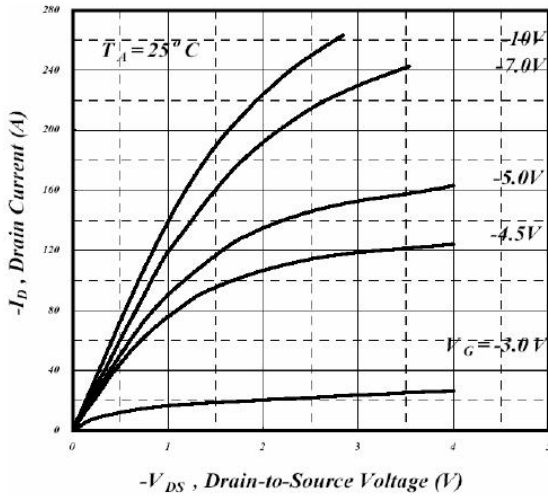

Fig 1. Typical Output Characteristics

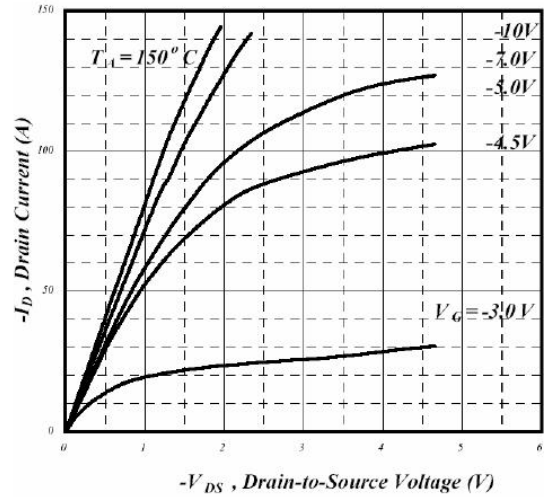

Fig 2. Typical Output Characteristics

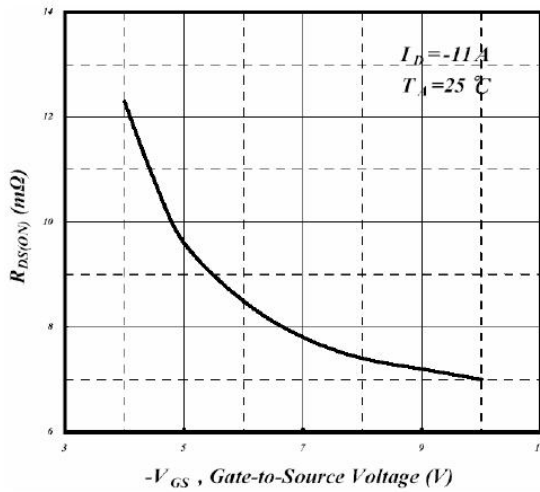

Fig 3. On-Resistance v.s. Gate Voltage

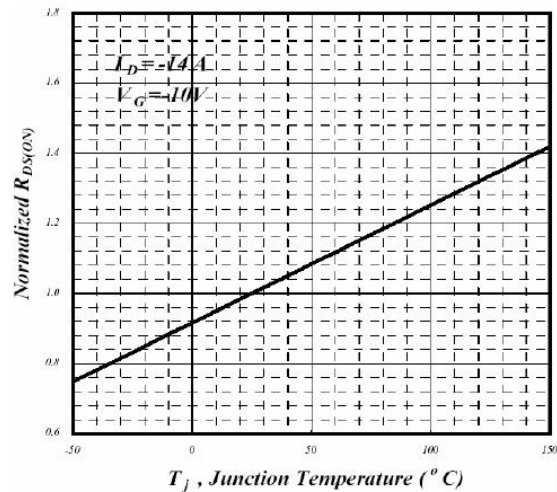

Fig 4. Normalized On-Resistance v.s. Junction Temperature

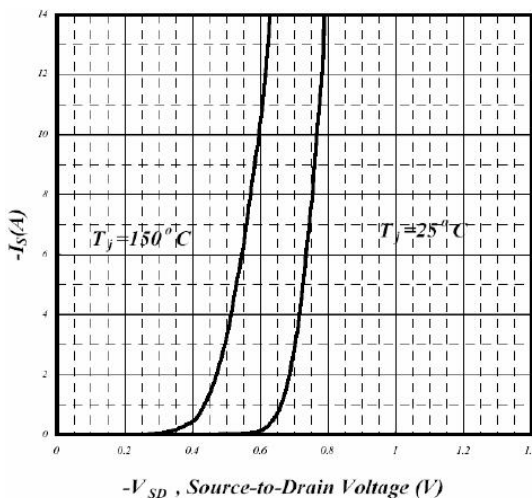

Fig 5. Forward Characteristics of Reverse Diode

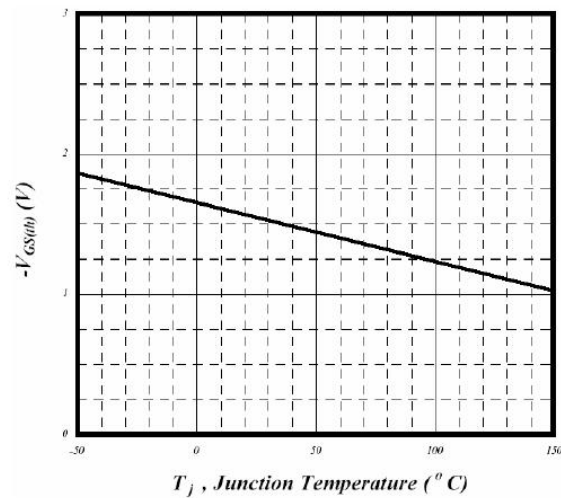

Fig 6. Gate Threshold Voltage v.s. Junction Temperature

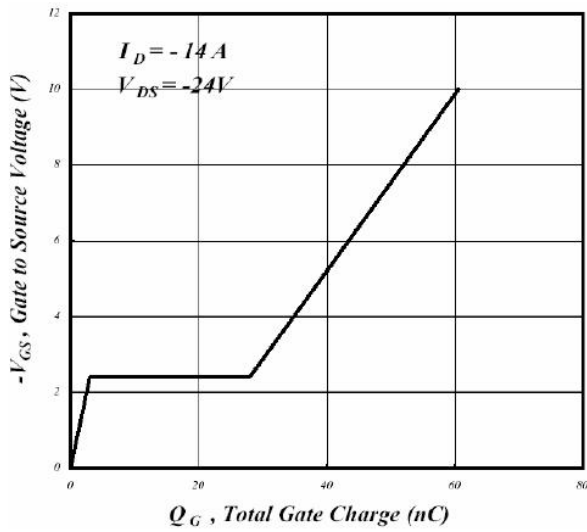

Fig 7. Gate Charge Characteristics

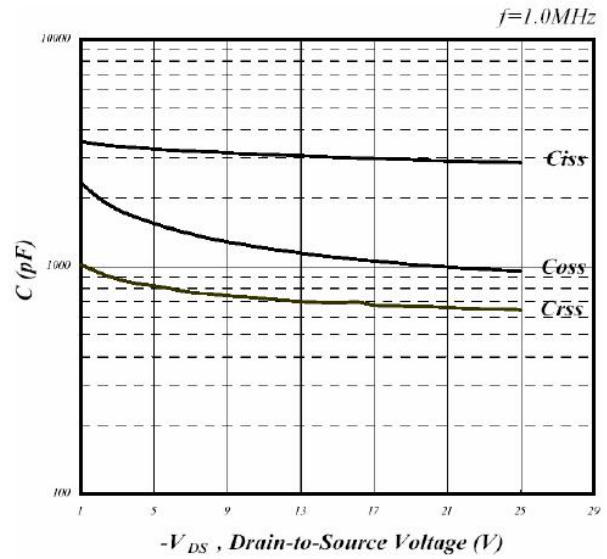

Fig 8. Typical Capacitance Characteristics

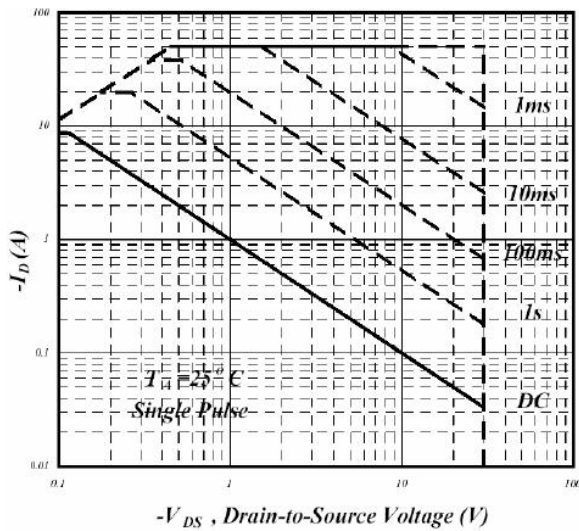

Fig 9. Maximum Safe Operating Area

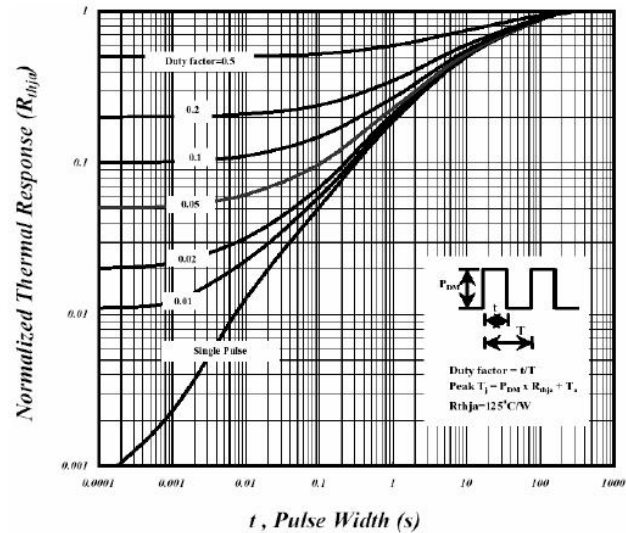

Fig 10. Effective Transient Thermal Impedance

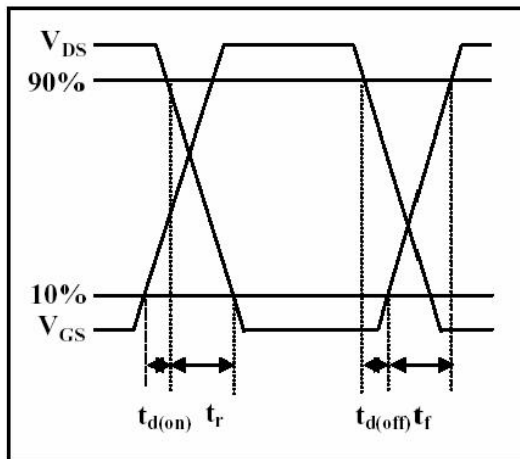

Fig 11. Switching Time Waveform

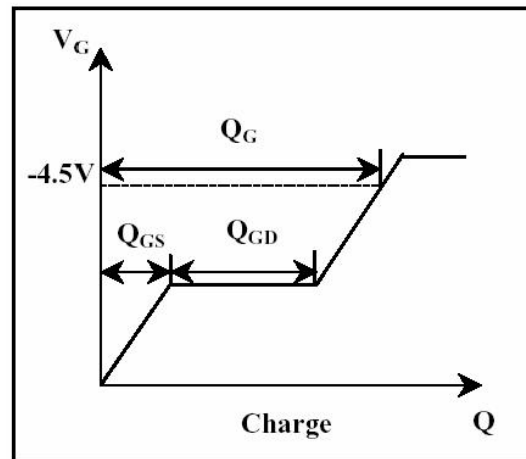
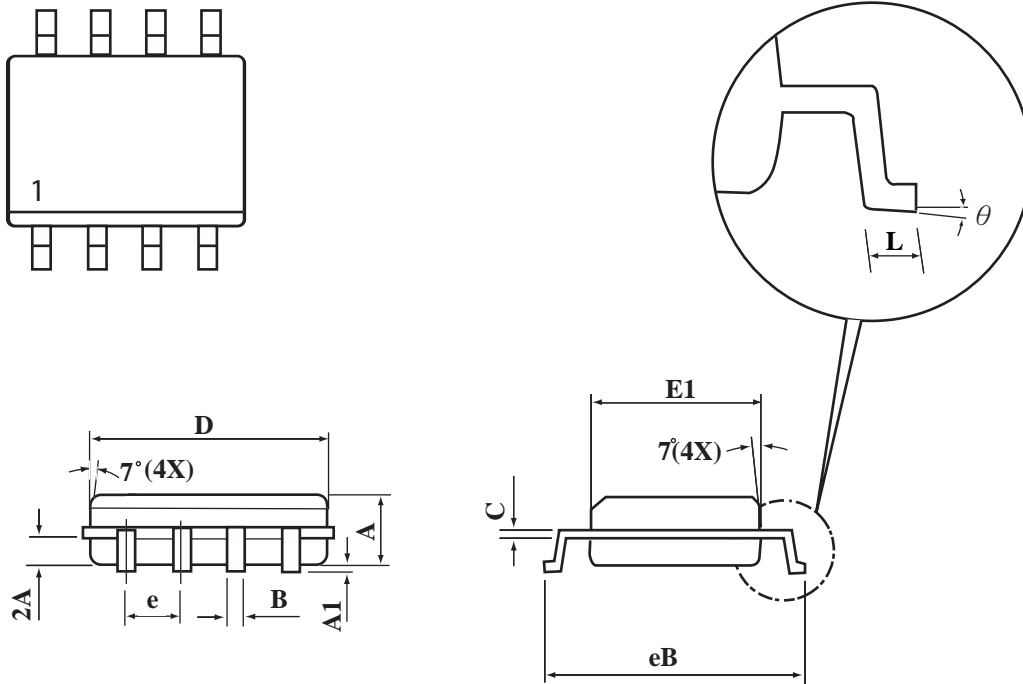

Fig 12. Gate Charge Waveform

SOP-8 Package Outline Dimensions

Unit:mm



SYMBOLS	MILLIMETERS	
	MIN	MAX
A	1.35	1.75
A1	0.10	0.20
B	0.35	0.45
C	0.18	0.23
D	4.69	4.98
E1	3.56	4.06
eB	5.70	6.30
e	1.27 BSC	
L	0.60	0.80
θ	0°	8°