

Surface Mount P-Channel Enhancement Mode MOSFET

(Pb) Lead(Pb)-Free

Features:

- * Super high dense
- * Cell design for low $R_{DS(ON)}$
- * $R_{DS(ON)} < 20m\Omega @ V_{GS} = -10V$
- * $R_{DS(ON)} < 35m\Omega @ V_{GS} = -4.5V$
- * Simple Drive Requirement
- * Lower On-resistance
- * Fast Switching

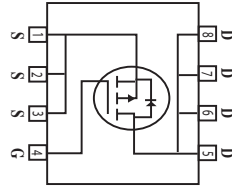

DRAIN CURRENT
-8 AMPERES
DRAIN SOURCE VOLTAGE
-30 VOLTAGE

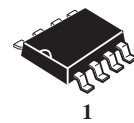

SOP-8

Description:

The WTK4435 provide the designer with the best combination of fast switching, ruggedized device design, low on-resistance and cost-effectiveness.

The SOP-8 package is universally preferred for all commercial-industrial surface mount applications and suited for low voltage applications such as DC/DC converters.

Maximum Ratings (T_A=25°C Unless Otherwise Specified)

Rating	Symbol	Value	Unite
Drain-Source Voltage	V _{DS}	-30	V
Gate-Source Voltage	V _{GS}	±20	V
Continuous Drain Current (T _A =25°C) (T _A =70°C)	I _D	-8 -6	A
Pulsed Drain Current ⁽¹⁾	I _{DM}	-50	A
Power Dissipation (T _A =25°C)	P _D	2.5	W
Maximax Junction-to-Ambient	R _{θJA}	50	°C/W
Operating Junction Temperature Range	T _J	+150	°C
Storage Temperature Range	T _{stg}	-55 to +150	°C

Device Marking

WTK4435=4435SC

Electrical Characteristics (T_A=25°C Unless otherwise noted)

Characteristic	Symbol	Min	Typ	Max	Unit
Static					
Drain-Source Breakdown Voltage V _{GS} =0V, I _D =-250 uA	V _{(BR)DSS}	-30	-	-	V
Gate-Source Threshold Voltage V _{DS} =V _{GS} , I _D =-250 uA	V _{GS(th)}	-1.0	-	-3.0	V
Gate-Source Leakage Current V _{DS} =0V, V _{GS} =±20V	I _{GSS}	-	-	±100	nA
Zero Gate Voltage Drain Current V _{DS} =-30V, V _{GS} =0V V _{DS} =-24V, V _{GS} =0V	I _{DSS}	-	-	-1 -5	μA
Drain-Source On-Resistance V _{GS} =-10V, I _D =-8A V _{GS} =-4.5V, I _D =-5A	R _{DS(on)}	- -	- -	20 35	mΩ
Forward Transconductance V _{DS} =-10V, I _D =-8A	g _{fs}	-	20	-	S

Dynamic

Input Capacitance V _{DS} =-15V, V _{GS} =0V, f=1MHZ	C _{iss}	-	2800	-	pF
Output Capacitance V _{DS} =-15V, V _{GS} =0V, f=1MHZ	C _{oss}	-	1400	-	
Reverse Transfer Capacitance V _{DS} =-15V, V _{GS} =0V, f=1MHZ	C _{rss}	-	350	-	

Switching

Turn-On Delay Time ⁽²⁾ V _{DS} = -15V, I _D = -1A, V _{GS} = -10V, R _G = 6Ω, R _D = 15Ω	t _{d(on)}	-	30	-	nS
Rise Time V _{DS} = -15V, I _D = -1A, V _{GS} = -10V, R _G = 6Ω, R _D = 15Ω	t _r	-	20	-	nS
Turn-Off Time V _{DS} = -15V, I _D = -1A, V _{GS} = -10V, R _G = 6Ω, R _D = 15Ω	t _{d(off)}	-	120	-	nS
Fall Time V _{DS} = -15V, I _D = -1A, V _{GS} = -10V, R _G = 6Ω, R _D = 15Ω	t _f	-	80	-	nS
Total Gate Charge ⁽²⁾ V _{DS} =-15V, I _D =-4.6A, V _{GS} =-10V	Q _g	-	47	-	nc
Gate-Source Charge V _{DS} =-15V, I _D =-4.6A, V _{GS} =-10V	Q _{gs}	-	9.5	-	nc
Gate-Drain Charge V _{DS} =-15V, I _D =-4.6A, V _{GS} =-10V	Q _{gd}	-	8	-	nc
Drain-Source Diode Forward Voltage ⁽²⁾ V _{GS} =0V, I _S =-2.1A	V _{SD}	-	-0.75	-1.2	V
Continuous Source Current(Body Diode) V _D =V _G =0V, V _S =-1.2V	I _S	-	-	-2.1	A
Pulsed Source Current(Body Diode) ⁽¹⁾	I _{SM}	-	-	-50	A

Notes: 1. Pulse width limited by Max. junction temperature.
2. Pulse width ≤ 300us, duty cycle ≤ 2%.

Characteristics Curve

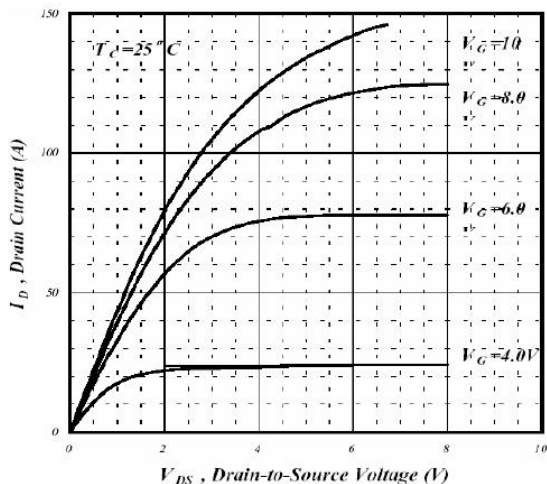

Fig 1. Typical Output Characteristics

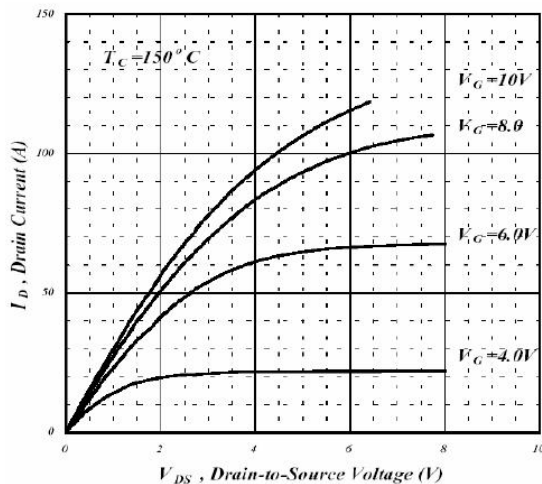

Fig 2. Typical Output Characteristics

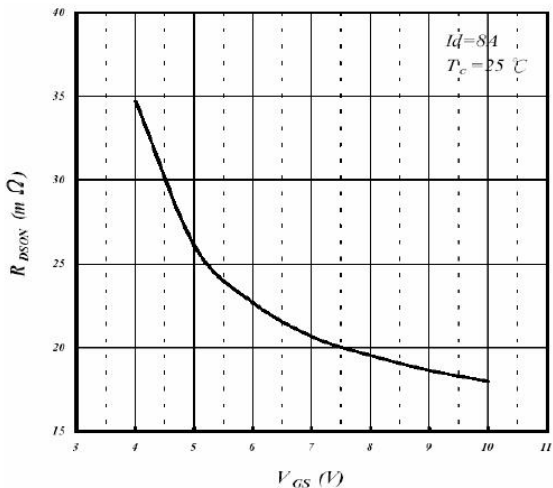

Fig 3. On-Resistance v.s. Gate Voltage

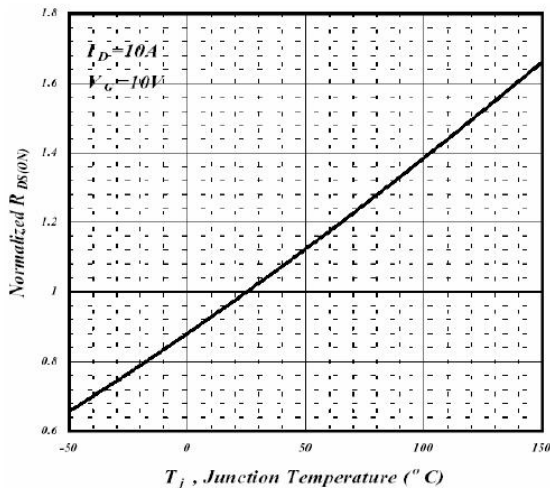

Fig 4. Normalized On-Resistance v.s. Junction Temperature

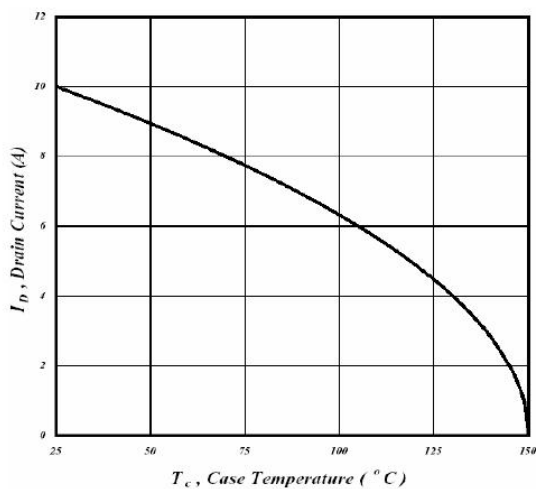

Fig 5. Maximum Drain Current v.s. Case Temperature

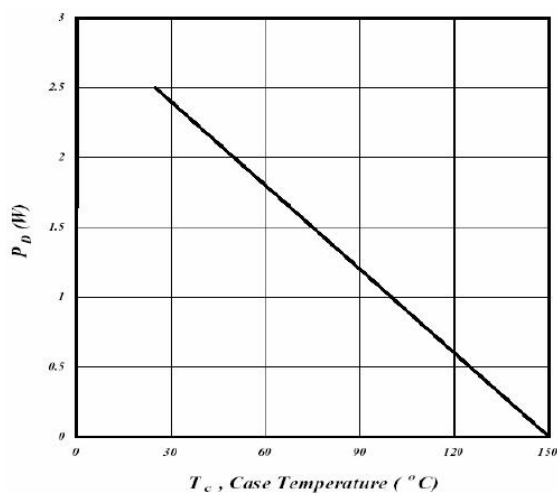

Fig 6. Type Power Dissipation

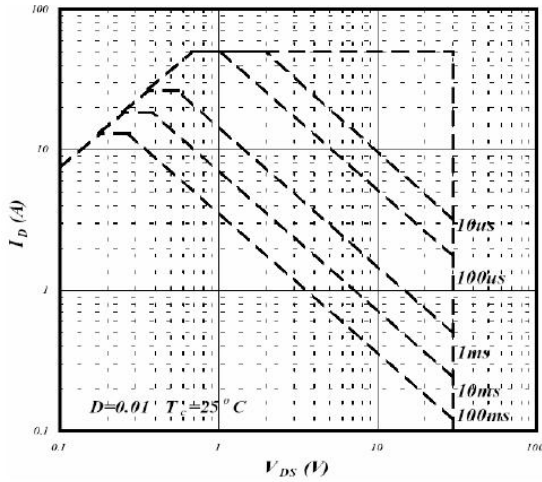

Fig 7. Maximum Safe Operating Area

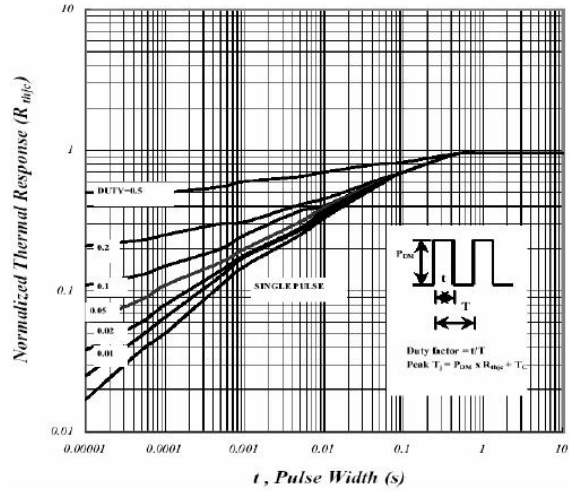

Fig 8. Effective Transient Thermal Impedance

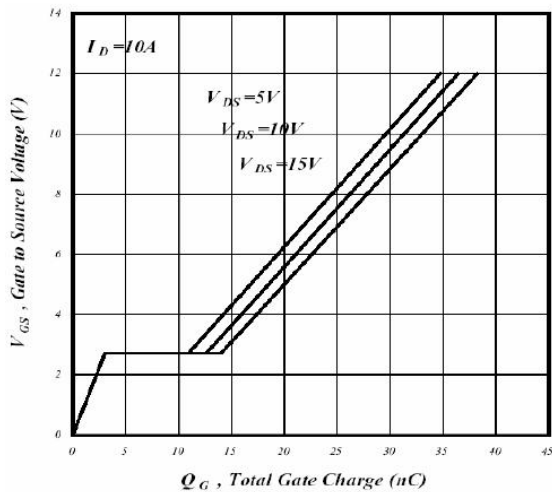

Fig 9. Gate Charge Characteristics

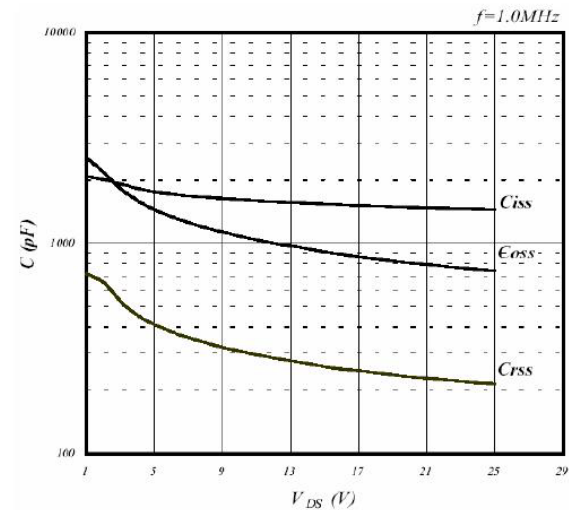

Fig 10. Typical Capacitance Characteristics

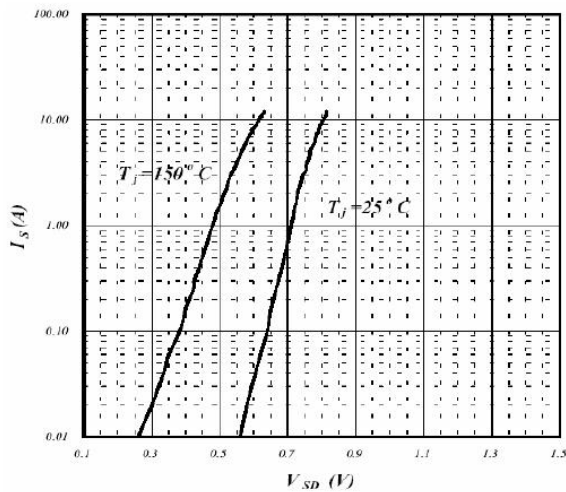

Fig 11. Forward Characteristics of Reverse Diode

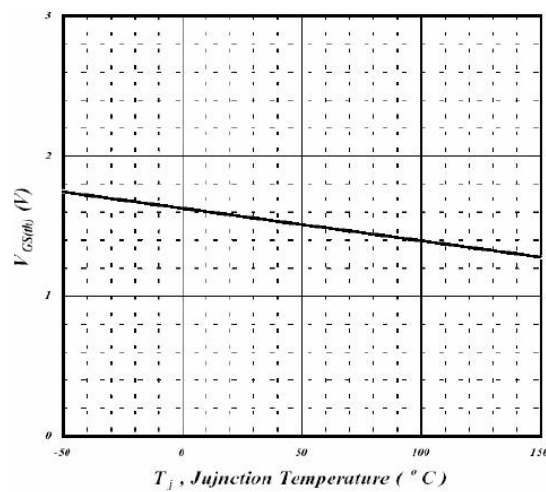

Fig 12. Gate Threshold Voltage v.s. Junction Temperature

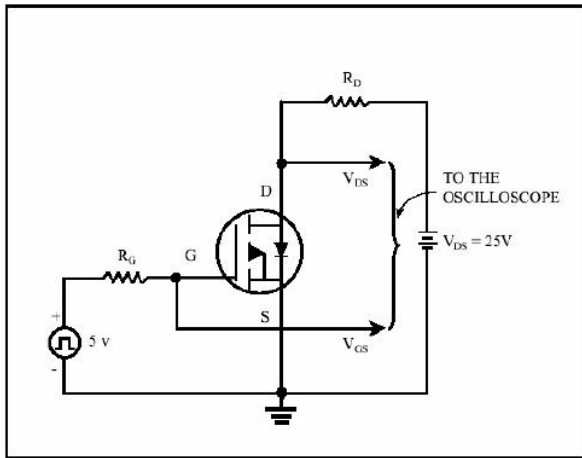

Fig 13. Switching Time Circuit

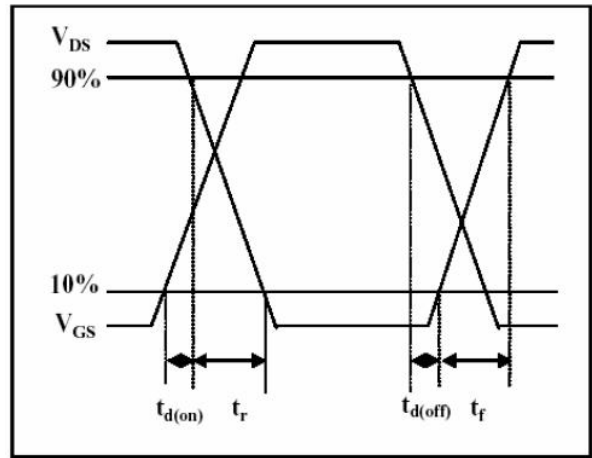

Fig 14. Switching Time Waveform

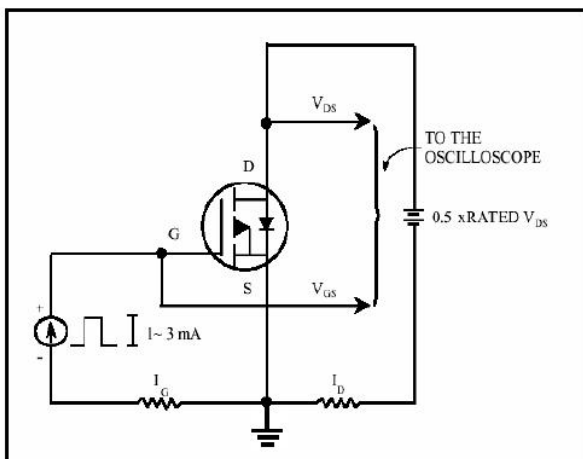

Fig 15. Gate Charge Circuit

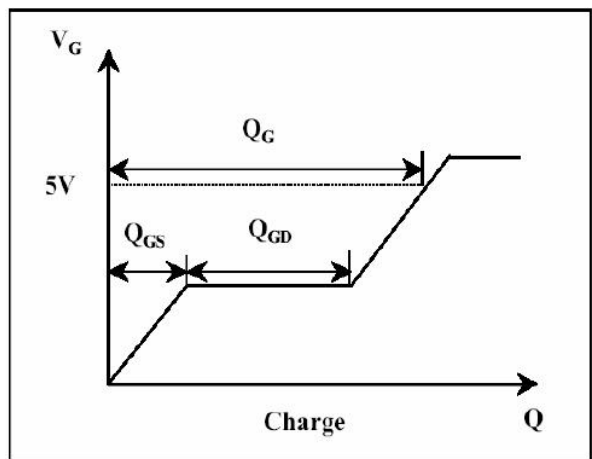
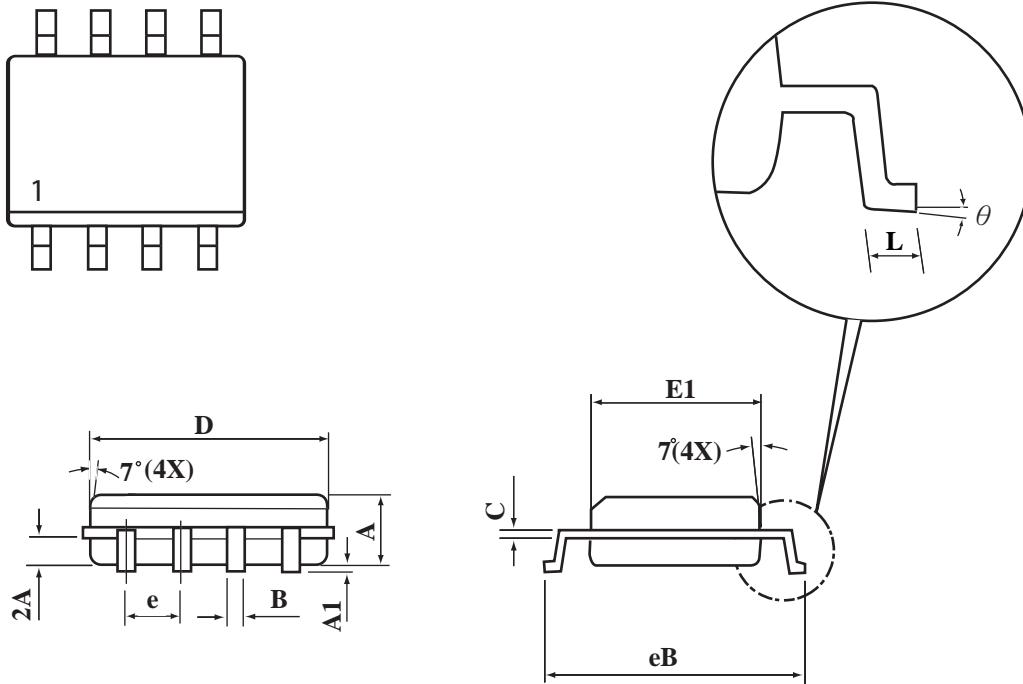

Fig 16. Gate Charge Waveform

SOP-8 Package Outline Dimensions

Unit:mm



SYMBOLS	MILLIMETERS	
	MIN	MAX
A	1.35	1.75
A1	0.10	0.20
B	0.35	0.45
C	0.18	0.23
D	4.69	4.98
E1	3.56	4.06
eB	5.70	6.30
e	1.27 BSC	
L	0.60	0.80
theta	0°	8°