

**Surface Mount P-Channel Enhancement
Mode POWER MOSFET**

(Pb) Lead(Pb)-Free

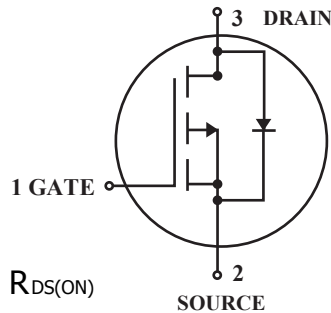

DRAIN CURRENT
-15 AMPERES
DRAIN SOURCE VOLTAGE
-60 VOLTAGE

Features:

*Super High Dense Cell Design For Low $R_{DS(ON)}$

$$R_{DS(ON)} < 90m \ \Omega @ V_{GS} = -10V$$

*Simple Drive Requirement

*Lower On-resistance

*Fast Switching Characteristic

*TO-252 Package

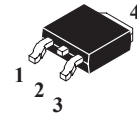

1. GATE
2,4 DRAIN
3. SOURCE

D-PAK / (TO-252)

Maximum Ratings ($T_a = 25^\circ C$ Unless Otherwise Specified)

Rating	Symbol	Value	Unit
Drain-Source Voltage	V_{DS}	30	V
Gate-Source Voltage	V_{GS}	± 20	
Continuous Drain Current, ($V_{GS} @ 10V, T_C = 25^\circ C$) , ($V_{GS} @ 10V, T_C = 100^\circ C$)	I_D	-20 -13	A
Pulsed Drain Current ¹	I_{DM}	150	
Total Power Dissipation ($T_C = 25^\circ C$)	P_D	50	W
Thermal Resistance Junction-case	$R_{\theta JC}$	2.5	$^\circ C/W$
Thermal Resistance Junction-ambient	$R_{\theta JA}$	110	$^\circ C/W$
Operating Junction and Storage Temperature Range	T_J, T_{stg}	-55~+150	$^\circ C$

Electrical Characteristics ($T_A = 25^\circ\text{C}$ Unless otherwise noted)

Characteristic	Symbol	Min	Typ	Max	Unit
Static					
Drain-Source Breakdown Voltage $I_D=250\mu\text{A}, V_{GS}=0$	BV_{DSS}	30	-	-	V
Gate-Source Threshold Voltage $I_D=250\mu\text{A}, V_{DS}=V_{GS}$	$V_{GS(Th)}$	1.0	-	3.0	
Gate-Source Leakage current $V_{GS}=\pm 20\text{V}$	I_{GSS}	-	-	± 100	nA
Drain-Source Leakage Current ($T_j=25^\circ\text{C}$) $V_{DS}=30\text{V}, V_{GS}=0$	I_{DSS}	-	-	25	μA
Drain-Source Leakage Current ($T_j=150^\circ\text{C}$) $V_{DS}=24\text{V}, V_{GS}=0$		-	-	250	
Static Drain-Source On-Resistance $I_D=18\text{A}, V_{GS}=10\text{V}$ $I_D=14\text{A}, V_{GS}=4.5\text{V}$	$R_{DS(on)}$	-	18 24	21 30	$\text{m}\Omega$
Forward Transconductance $I_D=18\text{A}, V_{DS}=10\text{V}$	g_{fs}	-	26	-	S

Dynamic

Input Capacitance $V_{GS}=0\text{V}, V_{DS}=25\text{V}, f=1.0\text{MHz}$	C_{iss}	-	800	-	pF
Output Capacitance $V_{GS}=0\text{V}, V_{DS}=25\text{V}, f=1.0\text{MHz}$	C_{oss}	-	380	-	
Reverse Transfer Capacitance $V_{GS}=0\text{V}, V_{DS}=25\text{V}, f=1.0\text{MHz}$	C_{rss}	-	133	-	

Switching

Turn-on Delay Time ² $I_D=18A, V_{DS}=15A, V_{GS}=10V, R_G=3.3\Omega, R_D=0.83\Omega$	$T_{d(on)}$	-	7.2	-	ns
Rise Time $I_D=18A, V_{DS}=15A, V_{GS}=10V, R_G=3.3\Omega, R_D=0.83\Omega$	T_r	-	60	-	
Turn-off Delay Time $I_D=18A, V_{DS}=15A, V_{GS}=10V, R_G=3.3\Omega, R_D=0.83\Omega$	$T_{d(off)}$	-	22.5	-	
Fall Time $I_D=18A, V_{DS}=15A, V_{GS}=10V, R_G=3.3\Omega, R_D=0.83\Omega$	T_f	-	10	-	
Total Gate CHarge ² $I_D=18A, V_{DS}=24V, V_{GS}=5V$	Q_g	-	17	-	nC
Gate-Source Charge $I_D=18A, V_{DS}=24V, V_{GS}=5V$	Q_{gs}	-	3	-	
Gate-Drain ("Miller") Charge $I_D=18A, V_{DS}=24V, V_{GS}=5V$	Q_{gd}	-	10	-	

Source-Drain Diode Characteristics

Forward On Voltage ² $I_S=36A, V_{GS}=0V, T_j=25^\circ C$	V_{SD}	-	-	1.3	V
Continuous Source Current (Body Diode) $V_D=V_G=0V, V_S=1.3V$	I_S	-	-	36	A
Pulsed Source Durrent (Body Diode) ¹	I_{SM}	-	-	150	A

Note: 1. Pulse width limited by safe operating area.
2. Pulse width $\leq 300\mu s$, duty cycle $\leq 2\%$.

Characteristics Curve

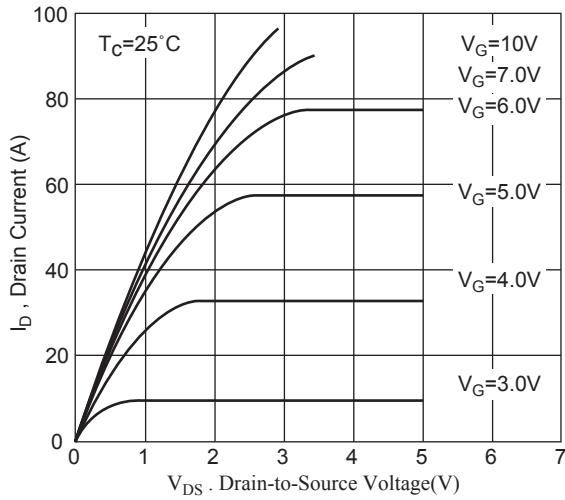

FIG.1 Typical Output Characteristics

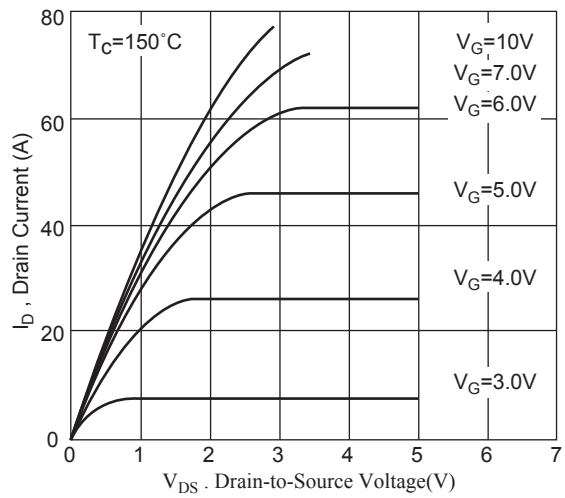

Fig.2 Typical Output Characteristics

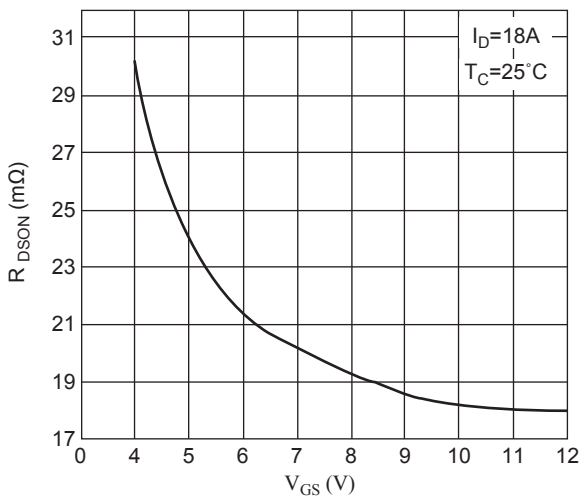

Fig.3 On-Resistance v.s. Gate Voltage

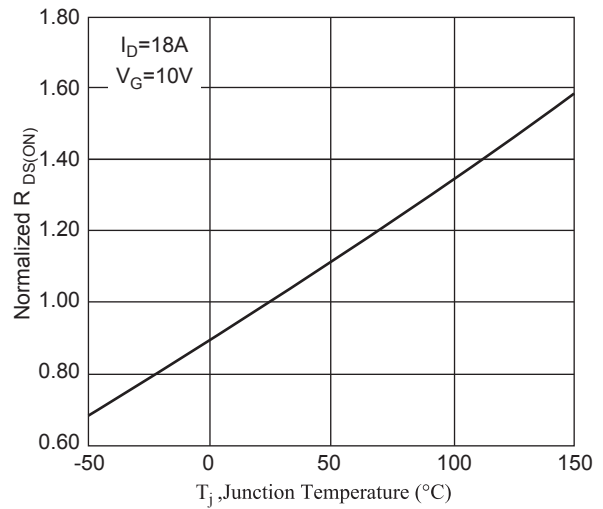

Fig.4 Normalized OnResistance

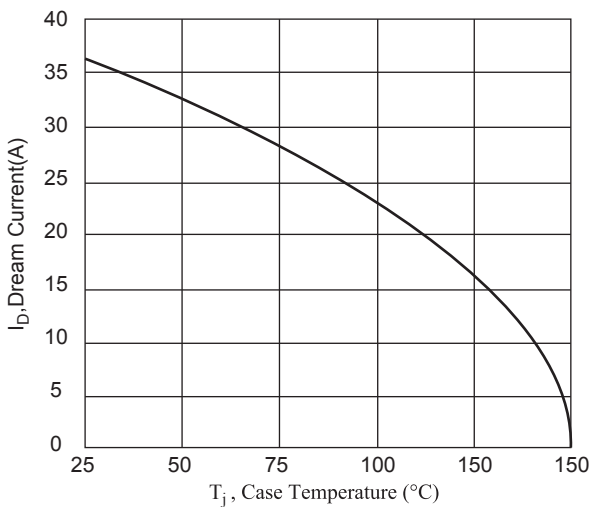

Fig.5 Maximum Drain Current v.s. Case Temperature

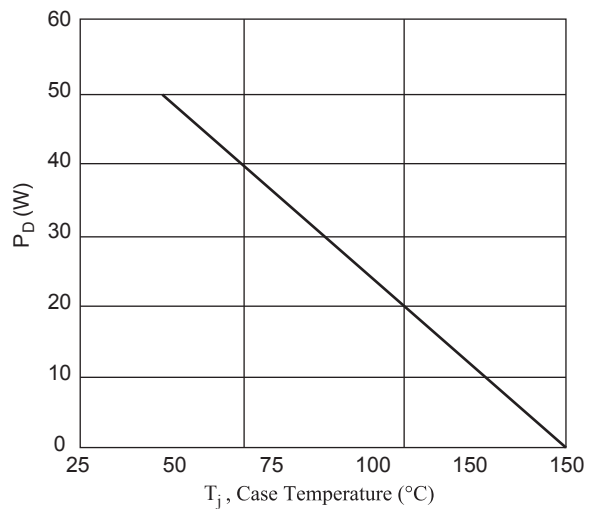

Fig.6 Type Power Diecepation

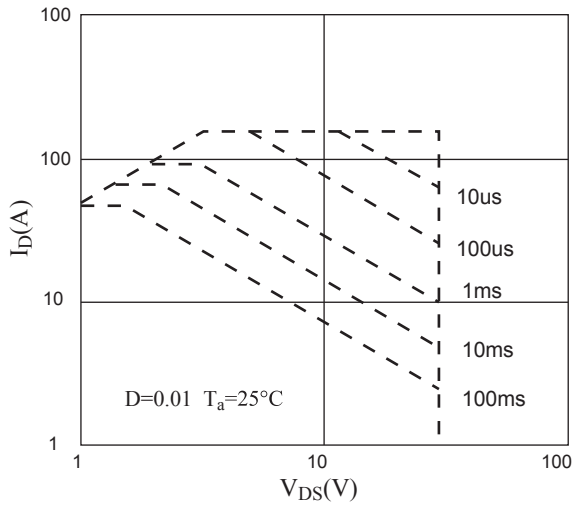

Fig 7. Maximum Safe Operating Area

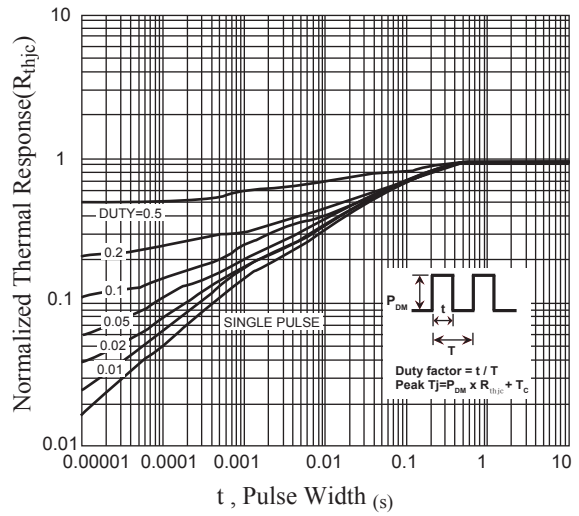

Fig 8. Effective Transient Thermal Impedance

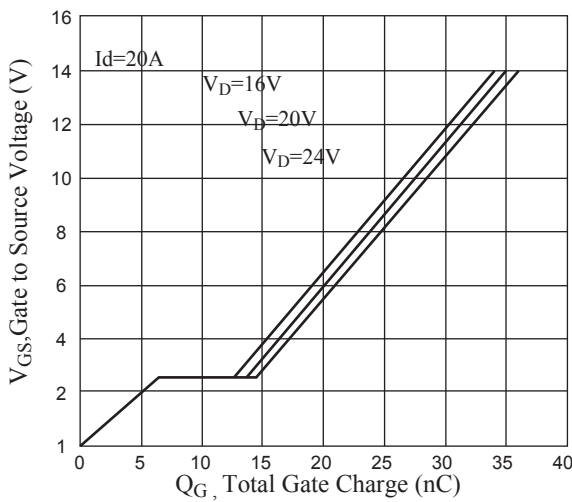

Fig 9. Gate Charge Characteristics

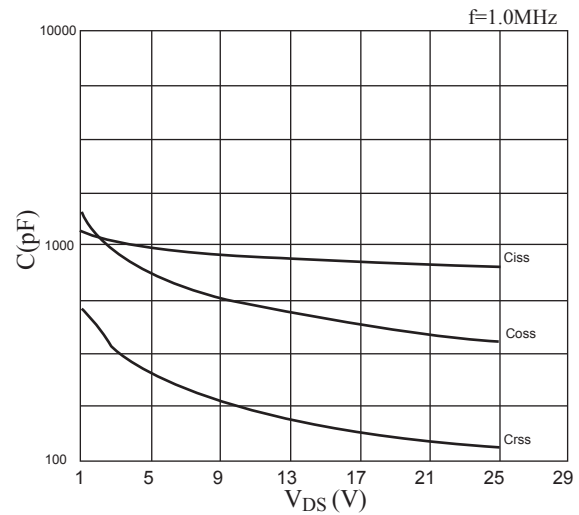

Fig 10. Typical Capacitance Characteristics

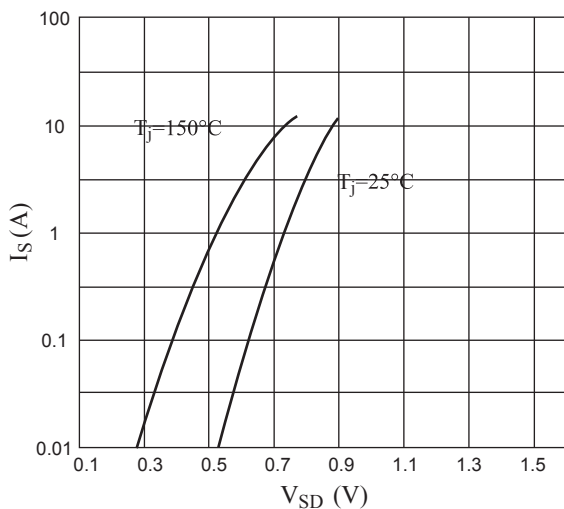

Fig 11. Forward Characteristics of Reverse Diode

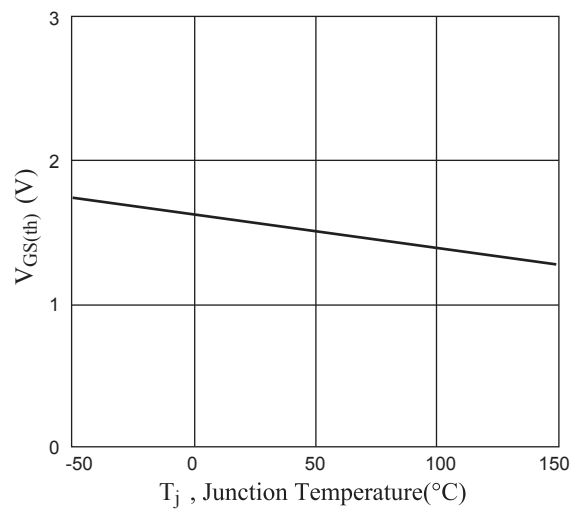
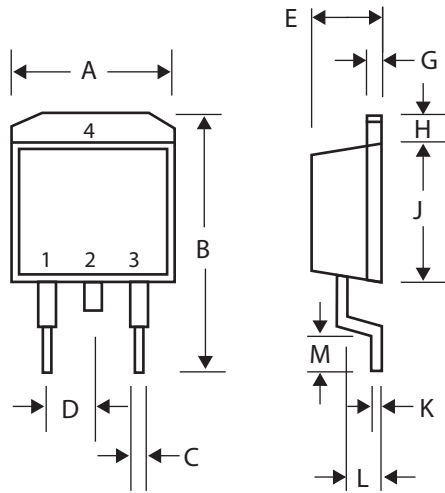

Fig.12 Gate Threshold Voltage v.s. Junction Temperature

D-PAK / (TO-252) Outline Dimension

Unit:mm



D-PAK		
Dim	Min	Max
A	6.40	6.80
B	9.00	10.00
C	0.50	0.80
D	-	2.30
E	2.20	2.50
G	0.45	0.55
H	1.00	1.60
J	5.40	5.80
K	0.30	0.64
L	0.70	1.70
M	0.90	1.50