

N-Channel Enhancement Mode Power MOSFET

(Pb) Lead(Pb)-Free

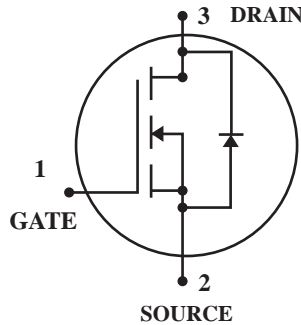

**DRAIN CURRENT
2.3 AMPERES**

**DRAIN SOURCE VOLTAGE
20 VOLTAGE**

Features:

- *Super High Dense Cell Design For Low $R_{DS(ON)}$
 $R_{DS(ON)} < 60m \Omega @ V_{GS} = 4.5V$
- *Rugged and Reliable
- *Simple Drive Requirement
- *SOT-23 Package

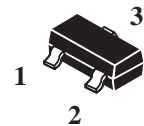

SOT-23

Maximum Ratings ($T_A = 25^\circ C$ Unless Otherwise Specified)

Rating	Symbol	Value	Unit
Drain-Source Voltage	V_{DS}	20	V
Gate-Source Voltage	V_{GS}	± 8	
Continuous Drain Current ³ ($T_A = 25^\circ C$)	I_D	2.3	A
Pulsed Drain Current ^{1,2}	I_{DM}	8	A
Total Power Dissipation ($T_A = 25^\circ C$)	P_D	0.9	W
Maximum Junction-ambient ³	$R_{\theta JA}$	145	$^\circ C/W$
Operating Junction and Storage Temperature Range	T_J, T_{stg}	-55~+150	$^\circ C$

Device Marking

WTC2302 = N02

Electrical Characteristics ($T_A = 25^\circ\text{C}$ Unless otherwise noted)

Characteristic	Symbol	Min	Typ	Max	Unit
----------------	--------	-----	-----	-----	------

Static

Drain-Source Breakdown Voltage $V_{GS}=0, I_D=-10\mu\text{A}$	$V_{(BR)DSS}$	20	-	-	V
Gate-Source Threshold Voltage $V_{DS}=V_{GS}, I_D=250\mu\text{A}$	$V_{GS(Th)}$	0.6	-	1.2	
Gate-Source Leakage Current $V_{GS}=\pm 8\text{V}$	I_{GSS}	-	-	± 100	nA
Drain-Source Leakage Current ($T_j=25^\circ\text{C}$) $V_{DS}=9.6\text{V}, V_{GS}=0$	I_{DSS}	-	-	-1	μA
Drain-Source On-Resistance $V_{GS}=4.5\text{V}, I_D=2.8\text{A}$ $V_{GS}=2.5\text{V}, I_D=2.0\text{A}$	$R_{DS(on)}$	- -	40 50	60 115	$\text{m}\Omega$
Forward Transconductance $V_{DS}=5\text{V}, I_D=4.0\text{A}$	g_{fs}	-	6.5	-	S

Dynamic

Input Capacitance $V_{GS}=0\text{V}, V_{DS}=6\text{V}, f=1.0\text{MHz}$	C_{iss}	-	427.12	-	pF
Output Capacitance $V_{GS}=0\text{V}, V_{DS}=6\text{V}, f=1.0\text{MHz}$	C_{oss}	-	80.56	-	
Reverse Transfer Capacitance $V_{GS}=0\text{V}, V_{DS}=6\text{V}, f=1.0\text{MHz}$	C_{rss}	-	57	-	

Switching

Turn-on Delay Time ² $V_{DD}=6V, V_{GEN}=4.5V, I_D=1.0A, R_L=6\Omega, R_G=6\Omega$	$t_d(\text{on})$	-	6.16	-	ns
Rise Time $V_{DD}=6V, V_{GEN}=4.5V, I_D=1.0A, R_L=6\Omega, R_G=6\Omega$	t_r	-	7.56	-	
Turn-off Delay Time $V_{DD}=6V, V_{GEN}=4.5V, I_D=1.0A, R_L=6\Omega, R_G=6\Omega$	$t_d(\text{off})$	-	16.61	-	
Fall Time $V_{DD}=6V, V_{GEN}=4.5V, I_D=1.0A, R_L=6\Omega, R_G=6\Omega$	t_f	-	4.07	-	
Total Gate Charge ² $V_{DS}=6V, V_{GS}=4.5V, I_D=2.8A$	Q_g	-	3.69	-	nC
Gate-Source Charge $V_{DS}=6V, V_{GS}=4.5V, I_D=2.8A$	Q_{gs}	-	0.7	-	
Gate-Drain Change $V_{DS}=6V, V_{GS}=4.5V, I_D=2.8A$	Q_{gd}	-	1.06	-	

Source-Drain Diode Characteristics

Forward On Voltage ² $V_{GS}=0V, I_S=-1.6A$	V_{SD}	-	-	1.2	V
Continuous Source Current(Body Diode)	I_S	-	-	1.6	A

- Note: 1. Pulse width limited by Max, junction temperature.
 2. pulse width $\leq 300\mu s$, duty cycle $\leq 2\%$.
 3. Surface mounted on 1 in² copper pad of FR4 board; 270°C/W when mounted on min, copper pad.

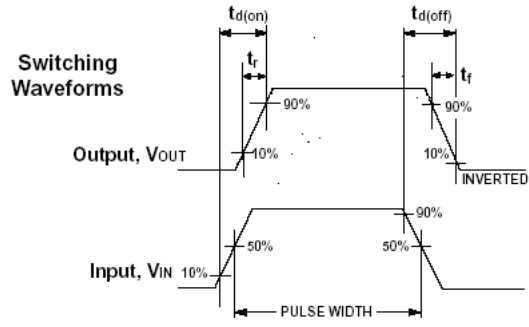
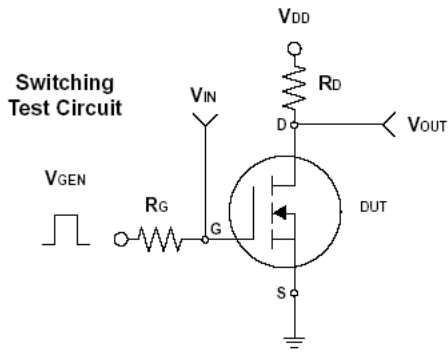

TYPICAL ELECTRICAL CHARACTERISTICS

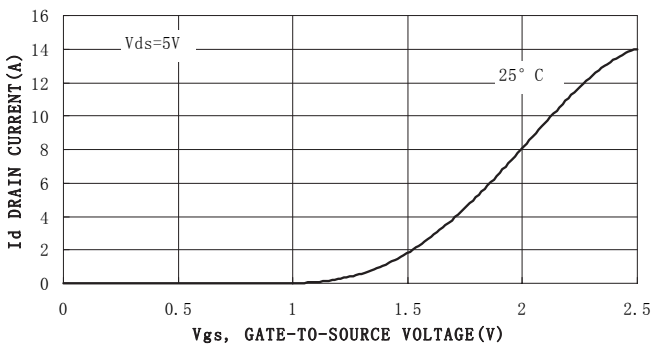

Figure 1. Transfer Characteristics

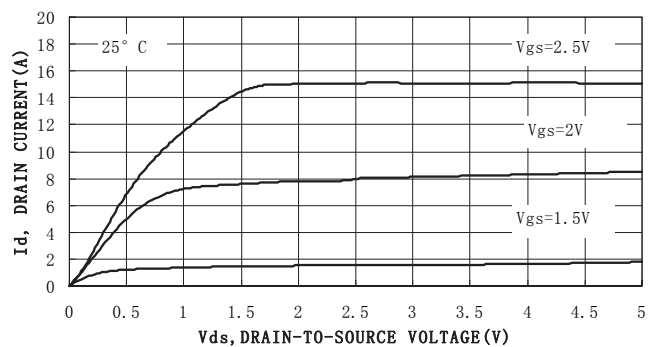

Figure 2. On-Region Characteristics

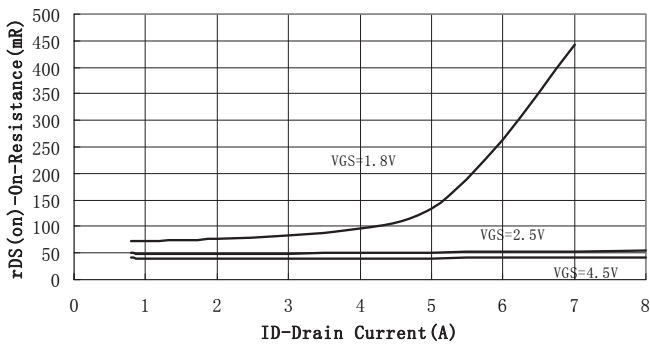

Figure 3. On-Resistance versus Drain Current

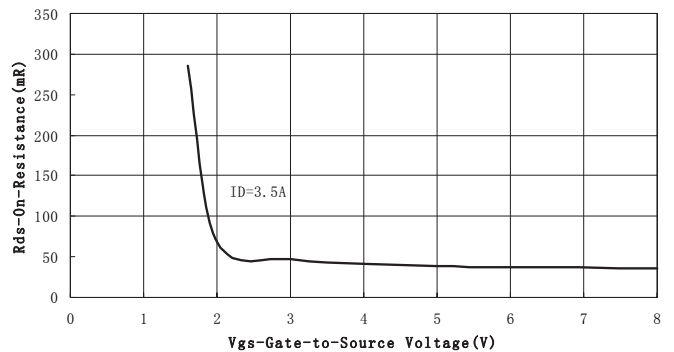

Figure 4. On-Resistance vs. Gate-to-Source Voltage

TYPICAL ELECTRICAL CHARACTERISTICS

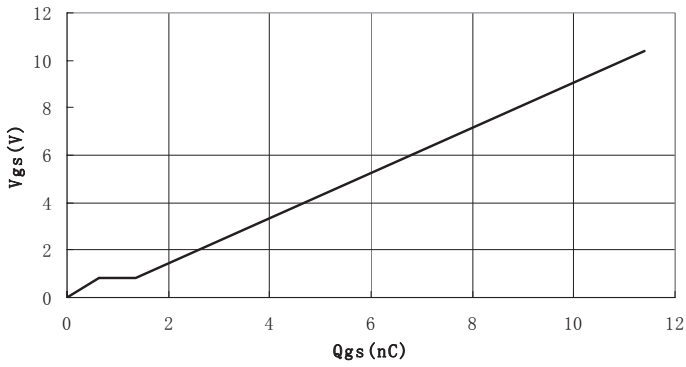

Figure 5. Gate Charge

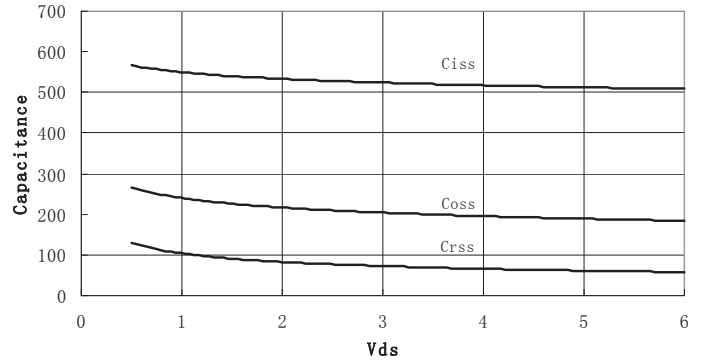

Figure 6. Capacitance

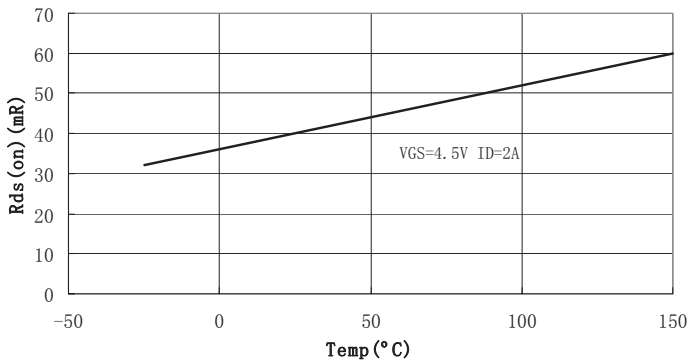

Figure 7. On-Resistance Vs. Junction Temperature

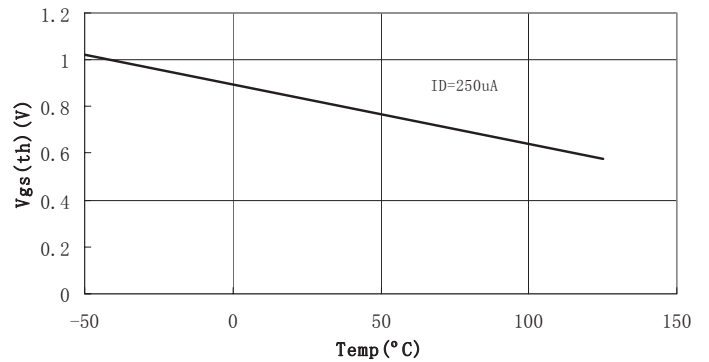

Figure 8. Vth Vs. Junction Temperature

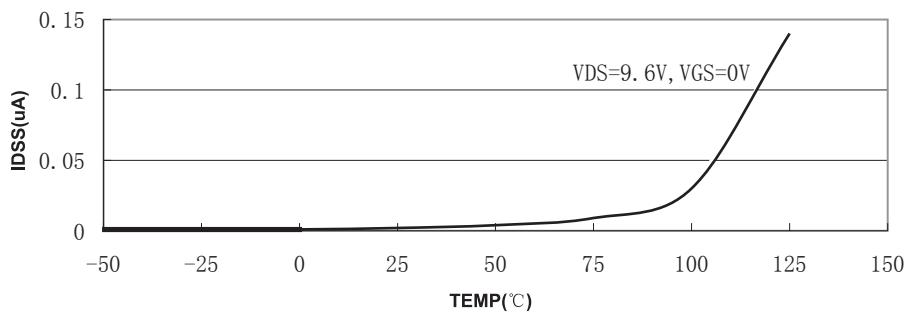
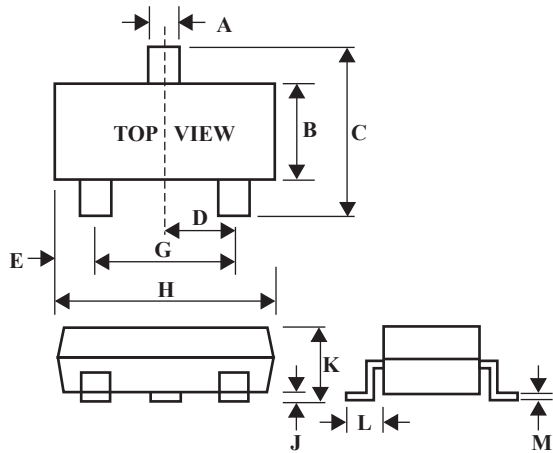

Figure 9. IDSS Vs. Junction Temperature

SOT-23 Outline Dimension



SOT-23		
Dim	Min	Max
A	0.35	0.51
B	1.19	1.40
C	2.10	3.00
D	0.85	1.05
E	0.46	1.00
G	1.70	2.10
H	2.70	3.10
J	0.01	0.13
K	0.89	1.10
L	0.30	0.61
M	0.076	0.25