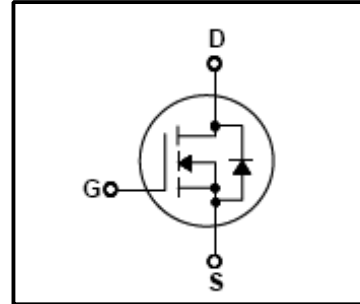


**Silicon N-Channel MOSFET**

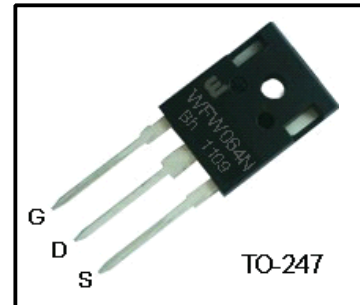
**Features**

- 109A,60V,  $R_{DS(on)}$ (Max 8m $\Omega$ )@ $V_{GS}=10V$
- Ultra-low Gate charge(Typical 50nC)
- Fast Switching Capability
- 100%Avalanche Tested
- Maximum Junction Temperature Range(150 $^{\circ}C$ )



**General Description**

This Power MOSFET is produced using Winsemi's advanced planar stripe,DMOS technology. This latest technology has been especially designed to minimize on-state resistance ,have a lowgate charge with superior switching performance ,and ruggedavalanche characteristics.This Power MOSFET is well suited for synchronous DC-DC Converters and power Management inportable and battery operated products.



**Absolute Maximum Ratings**

Symbol	Parameter	Value	Units
$V_{DSS}$	Drain Source Voltage	60	V
$I_D$	Continuous Drain Current(@ $T_c=25^{\circ}C$ )	109	A
	Continuous Drain Current(@ $T_c=100^{\circ}C$ )	80	A
$I_{DM}$	Drain Current Pulsed (Note1)	390	A
$V_{GS}$	Gate to Source Voltage	$\pm 20$	V
$E_{AR}$	Repetitive Avalanche Energy (Note1)	20	mJ
$dv/dt$	Peak Diode Recovery dv /dt (Note3)	5.0	V/ ns
	Total Power Dissipation(@ $T_c=25^{\circ}C$ )	185	W
$P_D$	Derating Factor above 25 $^{\circ}C$	1.1	W/ $^{\circ}C$
	Junction Temperature	150	$^{\circ}C$
$T_{stg}$	Storage Temperature	-55~150	$^{\circ}C$
$T_L$	Channel Temperature	300	$^{\circ}C$

**Thermal Characteristics**

Symbol	Parameter	Value			Units
		Min	Typ	Max	
$R_{QJC}$	Thermal Resistance , Junction -to -Case	-	-	0.68	$^{\circ}C/W$
$R_{QJA}$	Thermal Resistance , Junction-to -Ambient	-	-	40	$^{\circ}C/W$

**Electrical Characteristics(Tc=25°C)**

Characteristics	Symbol	Test Condition	Min	Typ	Max	Unit	
Gate leakage current	I <sub>GSS</sub>	V <sub>GS</sub> = ±20 V, V <sub>DS</sub> = 0 V	-	-	±100	nA	
Gate-source breakdown voltage	V <sub>(BR)GSS</sub>	I <sub>G</sub> =±10 μA, V <sub>DS</sub> =0V	±30	-	-	V	
Drain cut -off current	I <sub>DSS</sub>	V <sub>DS</sub> =55V, V <sub>GS</sub> =0V	-	-	25	μA	
		V <sub>DS</sub> =44V, V <sub>GS</sub> =0V, T <sub>J</sub> =125°C	-	-	250	μA	
Drain -source breakdown voltage	V <sub>(BR)DSS</sub>	I <sub>D</sub> =250 μA, V <sub>GS</sub> =0V	60	-	-	V	
Breakdown voltage Temperature Coefficient	ΔBV <sub>DSS</sub> / ΔT <sub>J</sub>	I <sub>D</sub> =1mA, Referenced to 25°C	-	0.057	-	V/°C	
Gate threshold voltage	V <sub>GS(th)</sub>	V <sub>DS</sub> =V <sub>GS</sub> , I <sub>D</sub> =250 μA	2	-	4	V	
Drain -source ON resistance	R <sub>DS(ON)</sub>	V <sub>GS</sub> =10V, I <sub>D</sub> =55A	-	-	8.0	mΩ	
Forward Transconductance	g <sub>fs</sub>	V <sub>DS</sub> =25V, I <sub>D</sub> =55A	44	-	-	S	
Input capacitance	C <sub>iss</sub>	V <sub>DS</sub> =25V,	-	3980	-	pF	
Reverse transfer capacitance	C <sub>rss</sub>	V <sub>GS</sub> =0V,	-	470	-		
Output capacitance	C <sub>oss</sub>	f=1MHz	-	1290	-		
Switching time	Rise time	t <sub>r</sub>	V <sub>DD</sub> =28V,	-	100	-	ns
	Turn-on Delay time	T <sub>d(on)</sub>	I <sub>D</sub> =55A	-	14	-	
	Fall time	t <sub>f</sub>	R <sub>G</sub> =2.5Ω	-	70	-	
	Turn-off Delay time	T <sub>d(off)</sub>	V <sub>GS</sub> =10V (Note4,5)	-	43	-	
Total gate charge(gate-source plus gate-drain)	Q <sub>g</sub>	V <sub>DS</sub> =44V, I <sub>D</sub> =55A	-	170	-	nC	
Gate-source charge	Q <sub>gs</sub>	V <sub>GS</sub> =10V,	-	32	-		
Gate-drain("miller") Charge	Q <sub>gd</sub>	(Note4,5)	-	74	-		

**Source-Drain Ratings and Characteristics(Ta=25°C)**

Characteristics	Symbol	Test Condition	Min	Type	Max	Unit
Continuous drain reverse current	I <sub>DR</sub>	-	-	-	109	A
Pulse drain reverse current	I <sub>DRP</sub>	-	-	-	390	A
Forward voltage(diode)	V <sub>DSF</sub>	I <sub>DR</sub> =1A, V <sub>GS</sub> =0V	-	-	1.2	V
Reverse recovery time	t <sub>rr</sub>	I <sub>DR</sub> =55A, T <sub>J</sub> =25°C	-	100	170	ns
Reverse recovery charge	Q <sub>rr</sub>	dI <sub>DR</sub> / dt =100 A / μs	-	450	680	μC

Note 1.Repeativity rating :pulse width limited by junction temperature

2.L=190uH I<sub>AS</sub>=55A,,R<sub>G</sub>=25Ω, Starting T<sub>J</sub>=25°C

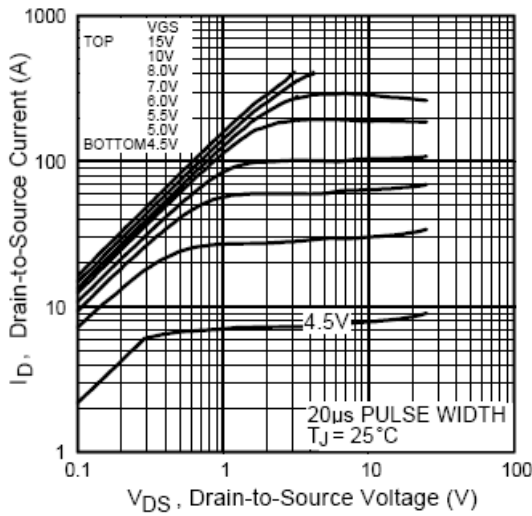
3.I<sub>SD</sub>≤55A, di/dt≤290A/us, V<sub>DD</sub><BV<sub>DSS</sub>, T<sub>J</sub>≤150°C

4.Pulse Test:Pulse Width≤400us,Duty Cycles≤2%

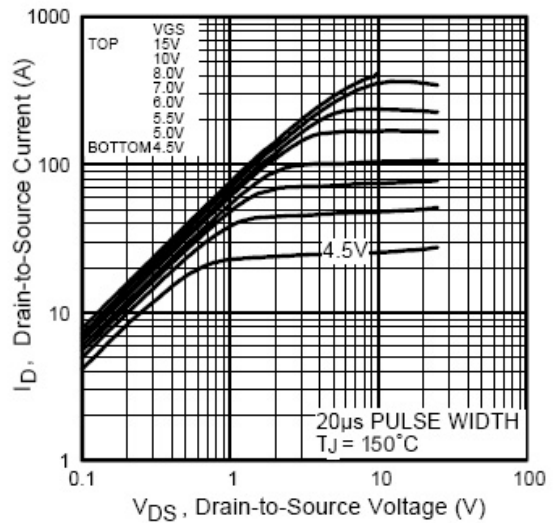
5. Essentially independent of operating temperature.

This transistor is an electrostatic sensitive device

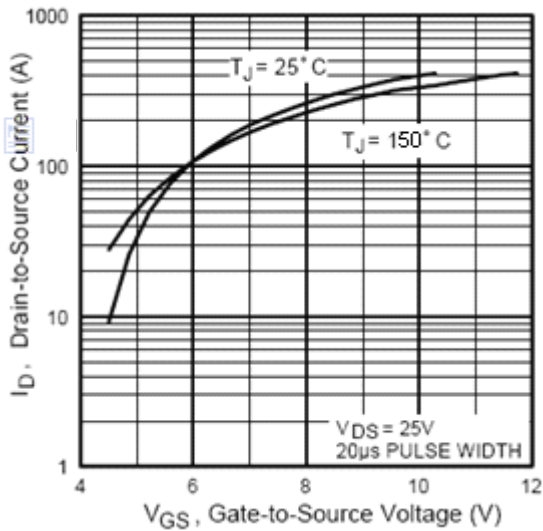
Please handle with caution



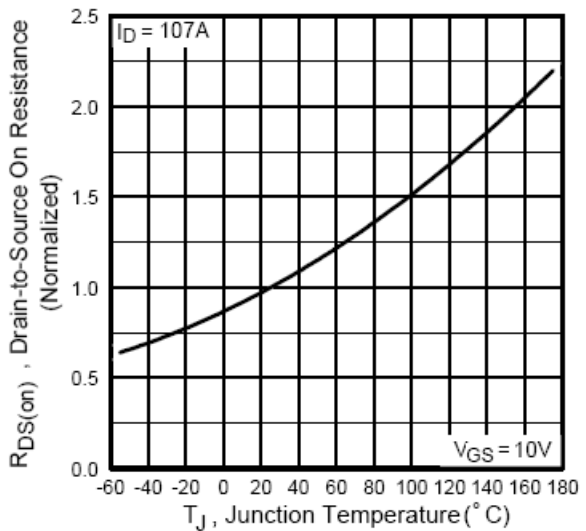
**Fig.1 On State Characteristics**



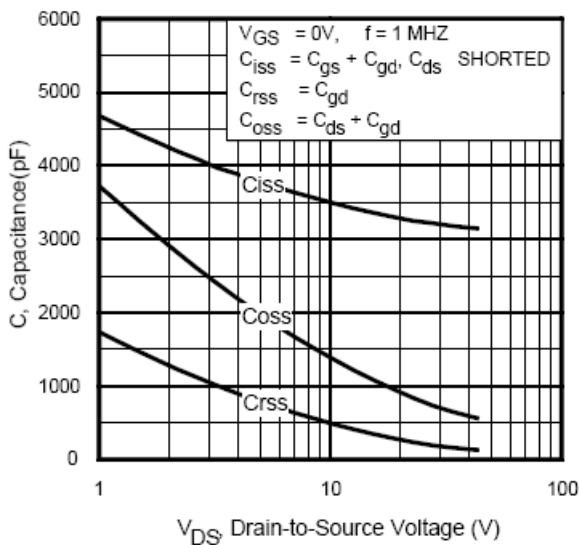
**Fig.2 On State Characteristics**



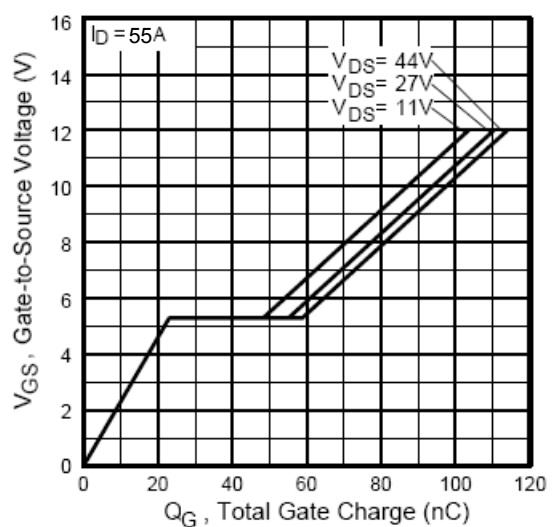
**Fig.3 Transfer Characteristics**



**Fig.4 On-Resistance Variation vs Junction temperature**

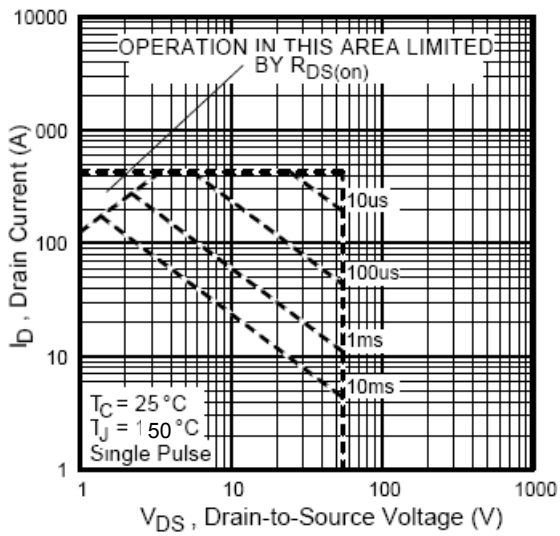


**Fig.5 Capacitance Variation vs Drain Voltage**

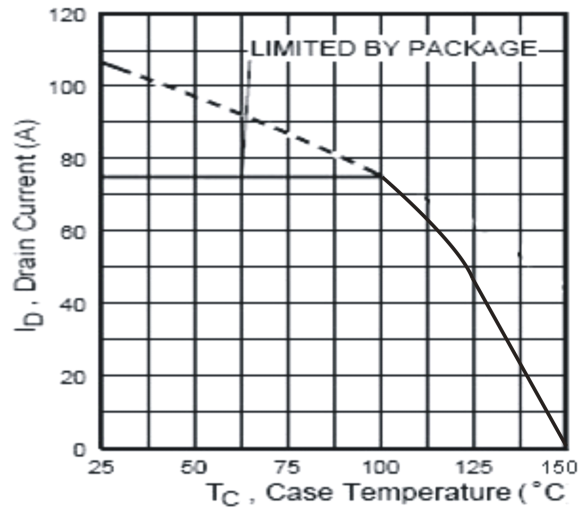


**Fig.6 Gate Charge Characteristics**

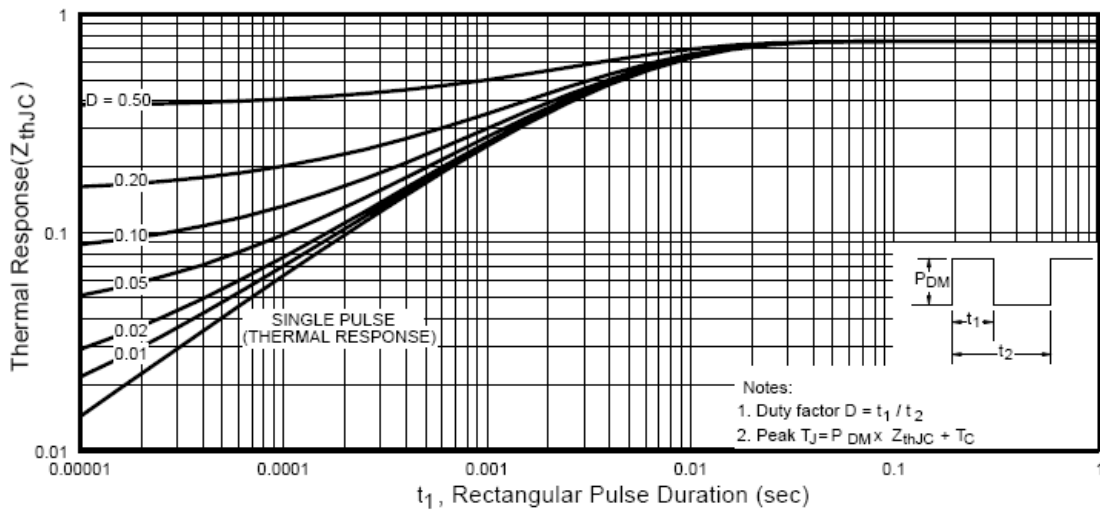




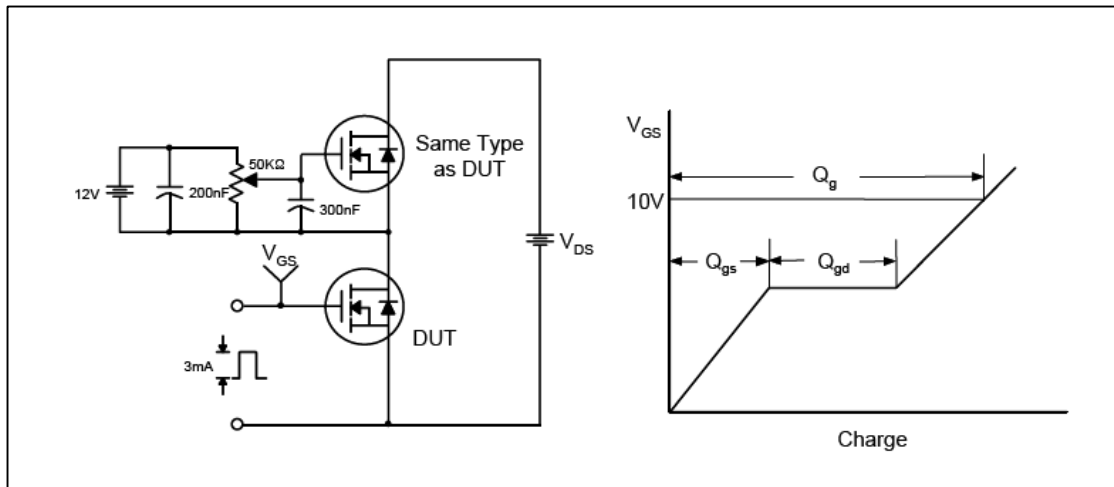
**Fig.7 Maximum Safe Operation Area**



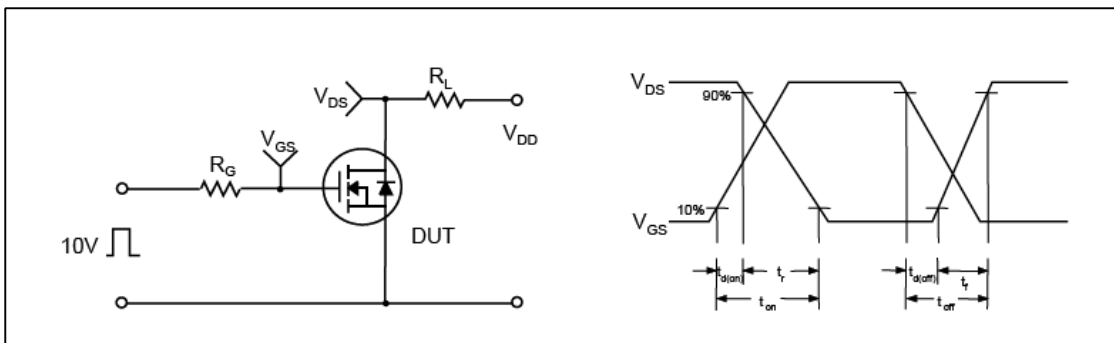
**Fig.8 Maximum Drain Current vs Case temperature**



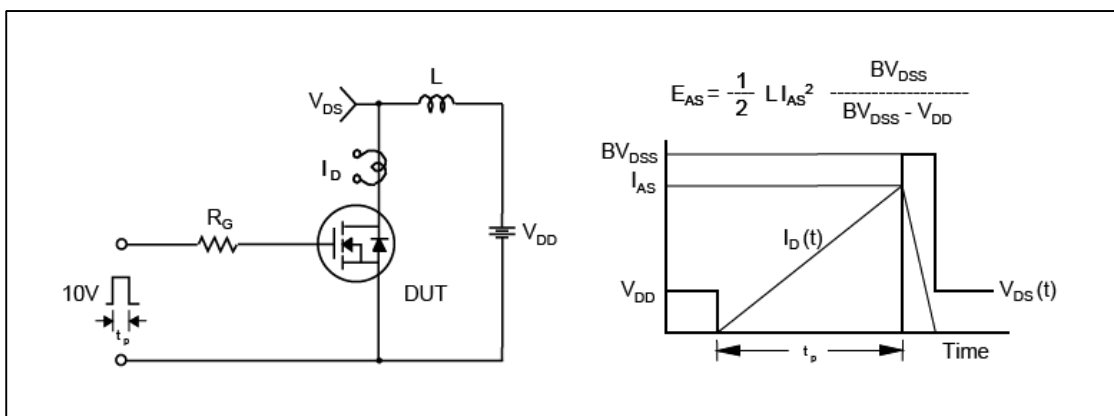
**Fig.9 Transient thermal Response Curve**



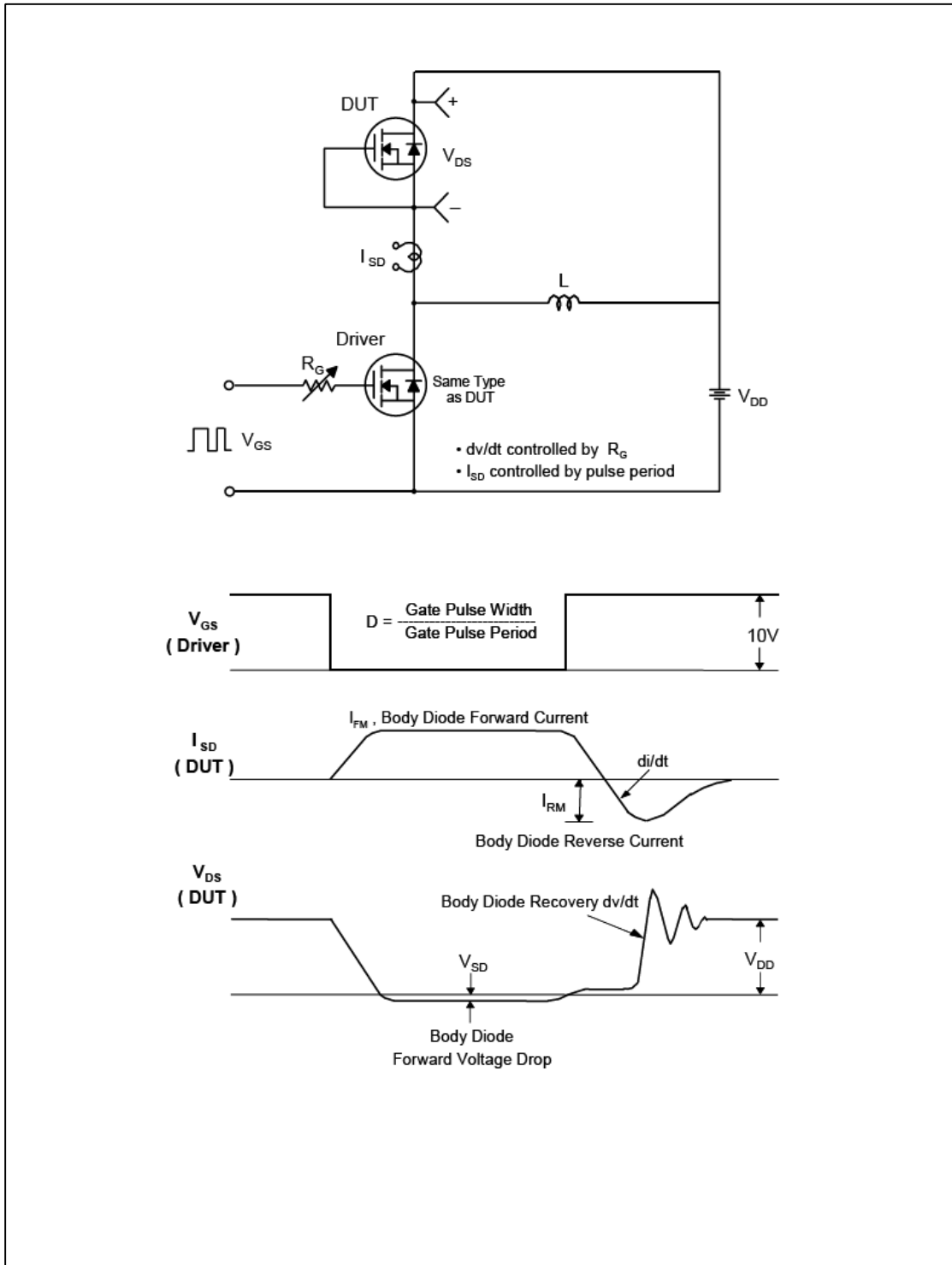
**Fig.10 Gate Test circuit & Waveform**



**Fig.11 Resistive Switching Test Circuit & Waveform**



**Fig.12 Unclamped Inductive Switching Test Circuit & Waveform**



**Fig.13 Peak Diode Recovery  $dv/dt$  Test Circuit & Waveform**

**TO-247 Package Dimension**

