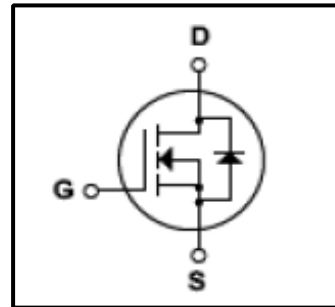


***Silicon N-Channel MOSFET***

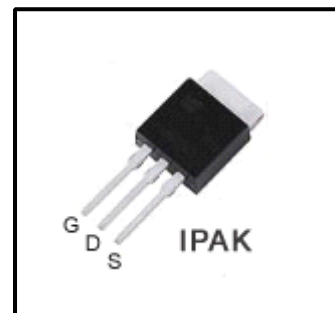
**Features**

- 4.5A,600V, $R_{DS(on)}$ (Max2.4 $\Omega$ )@ $V_{GS}=10V$
- Ultra-low Gate charge(Typical 15nC)
- Fast Switching Capability
- 100%Avalanche Tested
- Maximum Junction Temperature Range(150 $^{\circ}C$ )



**General Description**

This Power MOSFET is produced using Winsemi's advanced planar stripe,VDMOS technology.this latest technology has been especially designed to minimize on-state resistance, have a high rugged avalanche characteristics .This devices is specially well suited for half bridge and full bridge resonant topology line a electronic lamp ballast, high efficiency switched mode power supplies, active power factor correction.



**Absolute Maximum Ratings**

Symbol	Parameter	Value	Units
$V_{DSS}$	Drain Source Voltage	600	V
$I_D$	Continuous Drain Current(@ $T_c=25^{\circ}C$ )	4.5	A
	Continuous Drain Current(@ $T_c=100^{\circ}C$ )	3.1	A
$I_{DM}$	Drain Current Pulsed (Note1)	16	A
$V_{GS}$	Gate to Source Voltage	$\pm 30$	V
$E_{AS}$	Single Pulsed Avalanche Energy (Note2)	240	mJ
$E_{AR}$	Repetitive Avalanche Energy (Note1)	10	mJ
dv/dt	Peak Diode Recovery dv /dt (Note3)	4.5	V/ns
$P_D$	Total Power Dissipation(@ $T_c=25^{\circ}C$ )	50	W
	Derating Factor above 25 $^{\circ}C$	0.23	W/ $^{\circ}C$
$T_J$	Junction Temperature	150	$^{\circ}C$
$T_{stg}$	Storage Temperature	-55~150	$^{\circ}C$
$T_L$	Channel Temperature	300	$^{\circ}C$

**Thermal Characteristics**

Symbol	Parameter	Value			Units
		Min	Typ	Max	
$R_{QJC}$	Thermal Resistance , Junction -to -Case	-	-	2.5	$^{\circ}C/W$
$R_{QJA}$	Thermal Resistance , Junction-to -Ambient	-	-	62.5	$^{\circ}C/W$

**Electrical Characteristics(Tc=25 °C)**

Characteristics	Symbol	Test Condition	Min	Type	Max	Unit	
Gate leakage current	I <sub>GSS</sub>	V <sub>GS</sub> =±30V,V <sub>DS</sub> =0V	-	-	±100	nA	
Gate-source breakdown voltage	V <sub>(BR)GSS</sub>	I <sub>G</sub> =±10 μA,V <sub>DS</sub> =0V	±30	-	-	V	
Drain Cut -off current	I <sub>DSS</sub>	V <sub>DS</sub> =600V,V <sub>GS</sub> =0V	-	-	10	μA	
		V <sub>DS</sub> =480V,Tc=125 °C	-	-	100	μA	
Breakdown voltage Temperature coefficient	$\Delta BV_{DSS}/\Delta T_J$	I <sub>D</sub> =250 μA,Referenced to 25 °C	-	0.6	-	V/°C	
Drain -source breakdown voltage	V <sub>(BR)DSS</sub>	I <sub>D</sub> =250 μA,V <sub>GS</sub> =0V	600	-	-	V	
Gate threshold voltage	V <sub>GS(th)</sub>	V <sub>DS</sub> =V <sub>GS</sub> ,I <sub>D</sub> =250 μA	2	-	4	V	
Drain -source ON resistance	R <sub>DS(ON)</sub>	V <sub>GS</sub> =10V,I <sub>D</sub> =2.2A	-	2.0	2.4	Ω	
Forward Transconductance	g <sub>fs</sub>	V <sub>DS</sub> =50V,I <sub>D</sub> =2.2A	-	4.0	-	S	
Input capacitance	C <sub>iss</sub>	V <sub>DS</sub> =25V,	-	490	642	pF	
Reverse transfer capacitance	C <sub>rss</sub>	V <sub>GS</sub> =0V,	-	9	12		
Output capacitance	C <sub>oss</sub>	f=1MHz	-	95	124		
Switching time	Turn-on Rise time	tr	V <sub>DD</sub> =300V, I <sub>D</sub> =4.5A R <sub>G</sub> =25Ω (Note4,5)	-	49	111	ns
	Turn-on delay time	Td(on)		-	16	42	
	Turn-off Fall time	tf		-	37	84	
	Turn-off delay time	Td(off)		-	46	102	
Total gate charge(gate-source plus gate-drain)	Q <sub>g</sub>	V <sub>DD</sub> =480V, V <sub>GS</sub> =10V,	-	15	20	nC	
Gate-source charge	Q <sub>gs</sub>	I <sub>D</sub> =4.4A	-	3.4	-		
Gate-drain("miller") Charge	Q <sub>gd</sub>	(Note,5)	-	7.1	-		

**Source-Drain Ratings and Characteristics(Ta=25 °C)**

Characteristics	Symbol	Test Condition	Min	Type	Max	Unit
Continuous drain reverse current	I <sub>DR</sub>	-	-	-	4.5	A
Pulse drain reverse current	I <sub>DRP</sub>	-	-	-	17.6	A
Forward voltage(diode)	V <sub>DSF</sub>	I <sub>DR</sub> =4.4A,V <sub>GS</sub> =0V	-	-	1.4	V
Reverse recovery time	trr	I <sub>DR</sub> =4.4A,V <sub>GS</sub> =0V,	250	-	-	ns
Reverse recovery charge	Q <sub>rr</sub>	dI <sub>DR</sub> /dt =100 A /μs	1.5	-	-	μC

Note 1.Repeativity rating :pulse width limited by junction temperature

2.L=25mH I<sub>AS</sub>=4.4A,V<sub>DD</sub>=50V,R<sub>G</sub>=25Ω,Starting T<sub>J</sub>=25 °C

3.I<sub>SD</sub>≤4.5A,di/dt≤200A/μs,V<sub>DD</sub><BV<sub>DSS</sub>,STARTING T<sub>J</sub>=25 °C

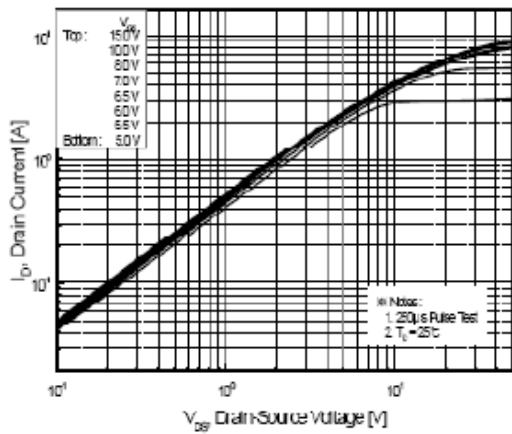
4.Pulse Test:Pulse Width≤300us,Duty Cycle≤2%

5. Essentially independent of operating temperature.

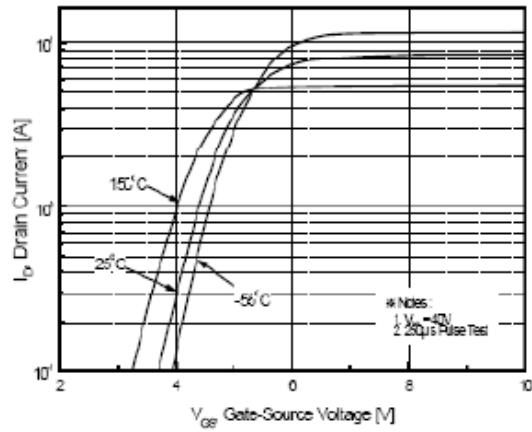
This transistor is an electrostatic sensitive device

Please handle with caution

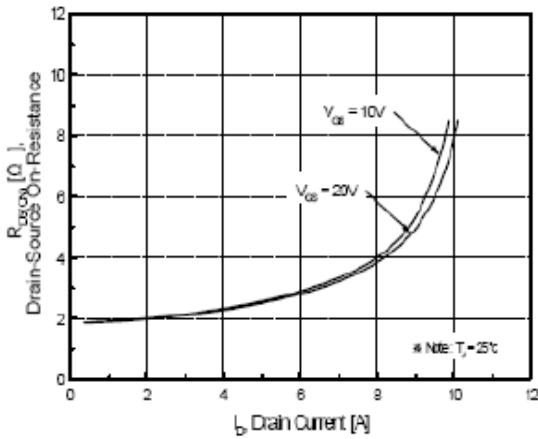




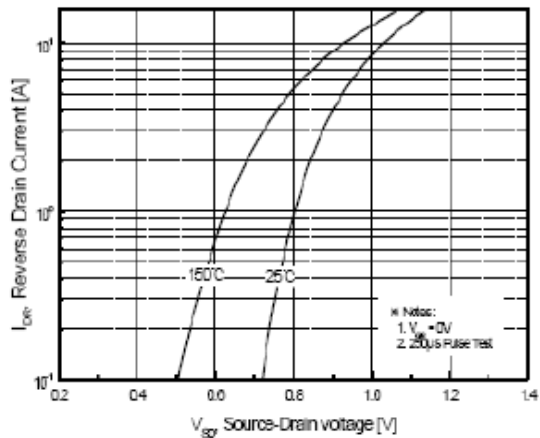
**Fig.1 On-State characteristics**



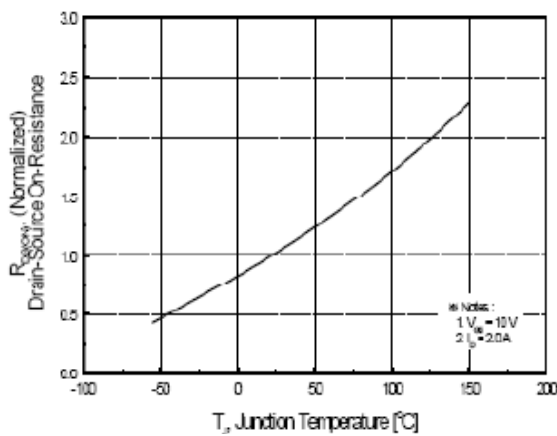
**Fig.2 Transfer Current characteristics**



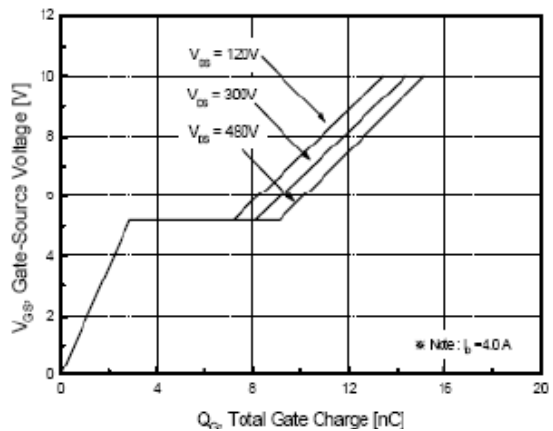
**Fig.3 On-Resistance Variation vs Drain Current**



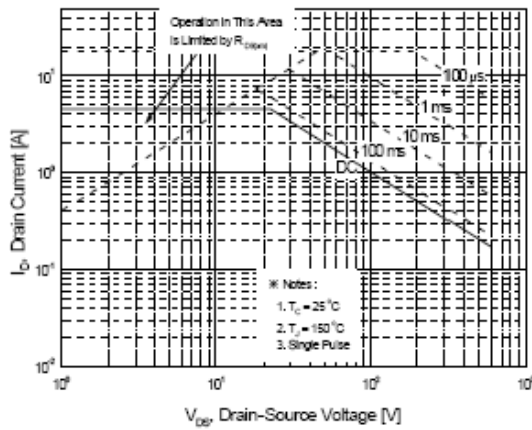
**Fig.4 Body Diode Forward Voltage Variation with Source Current and Temperature**



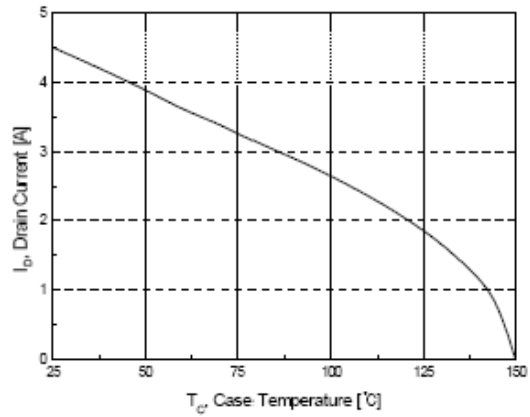
**Fig.5 On-Resistance Variation vs Junction Temperature**



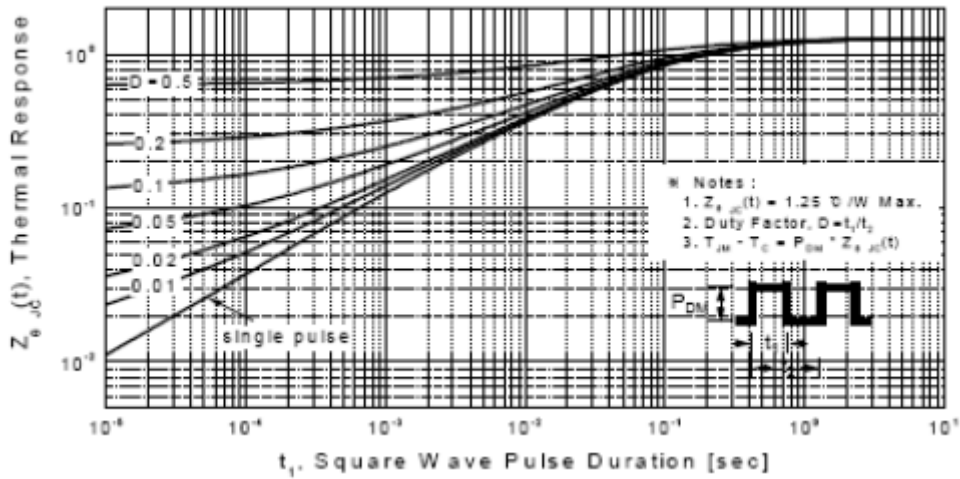
**Fig.6 Gate Charge Characteristics**



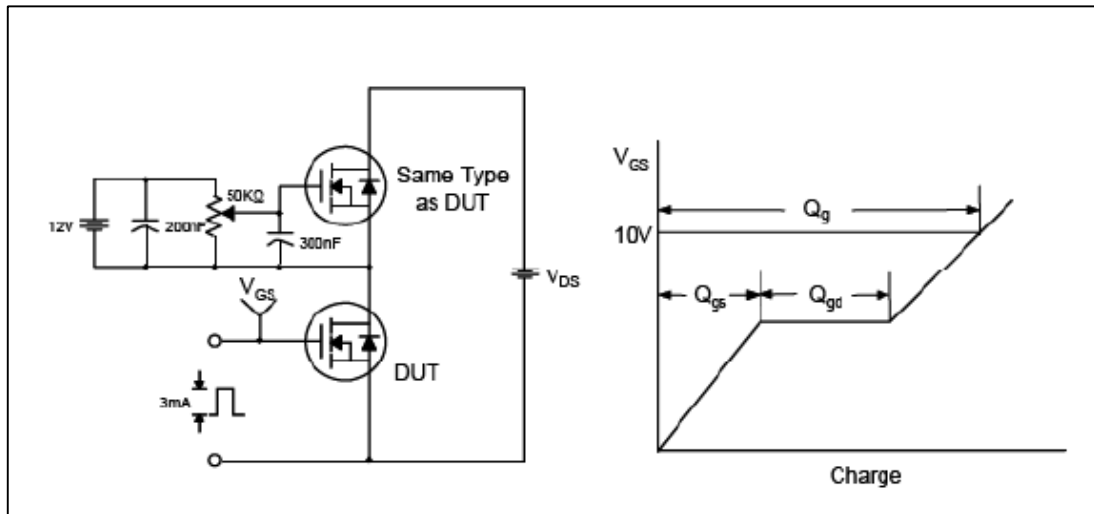
**Fig.7 Maximum Safe Operation Area**



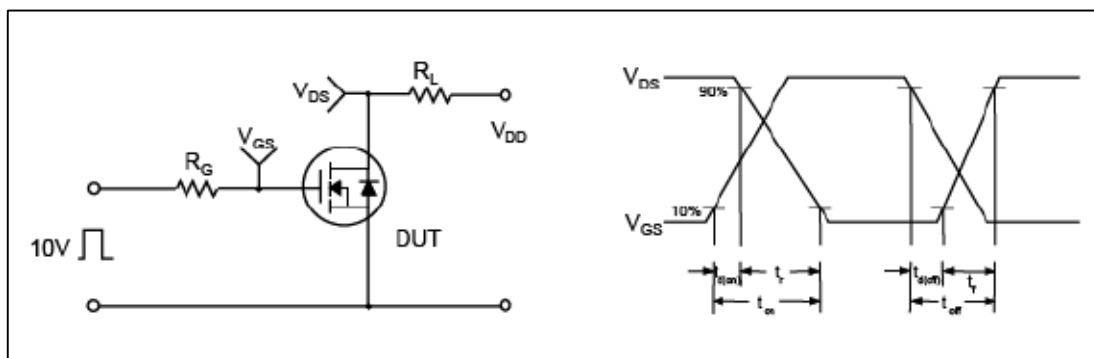
**Fig.8 Maximum Drain Current vs Case Temperature**



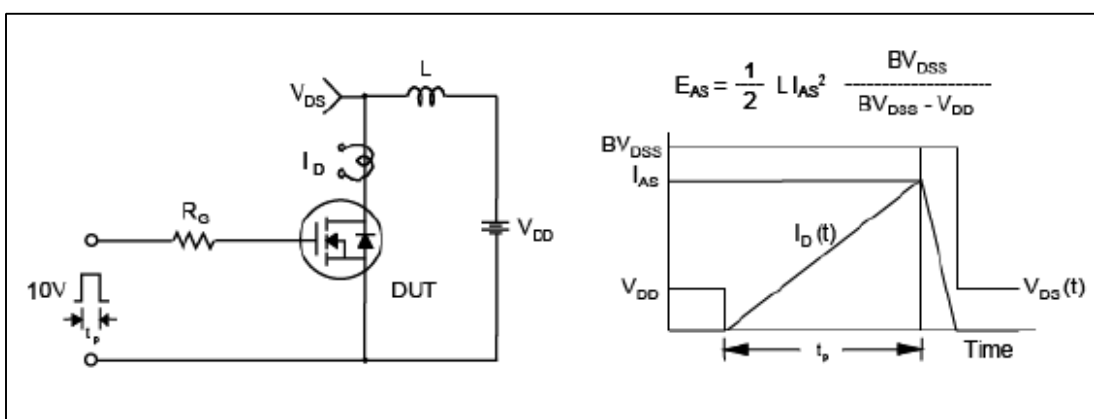
**Fig.9 Transient Thermal Response Curve**



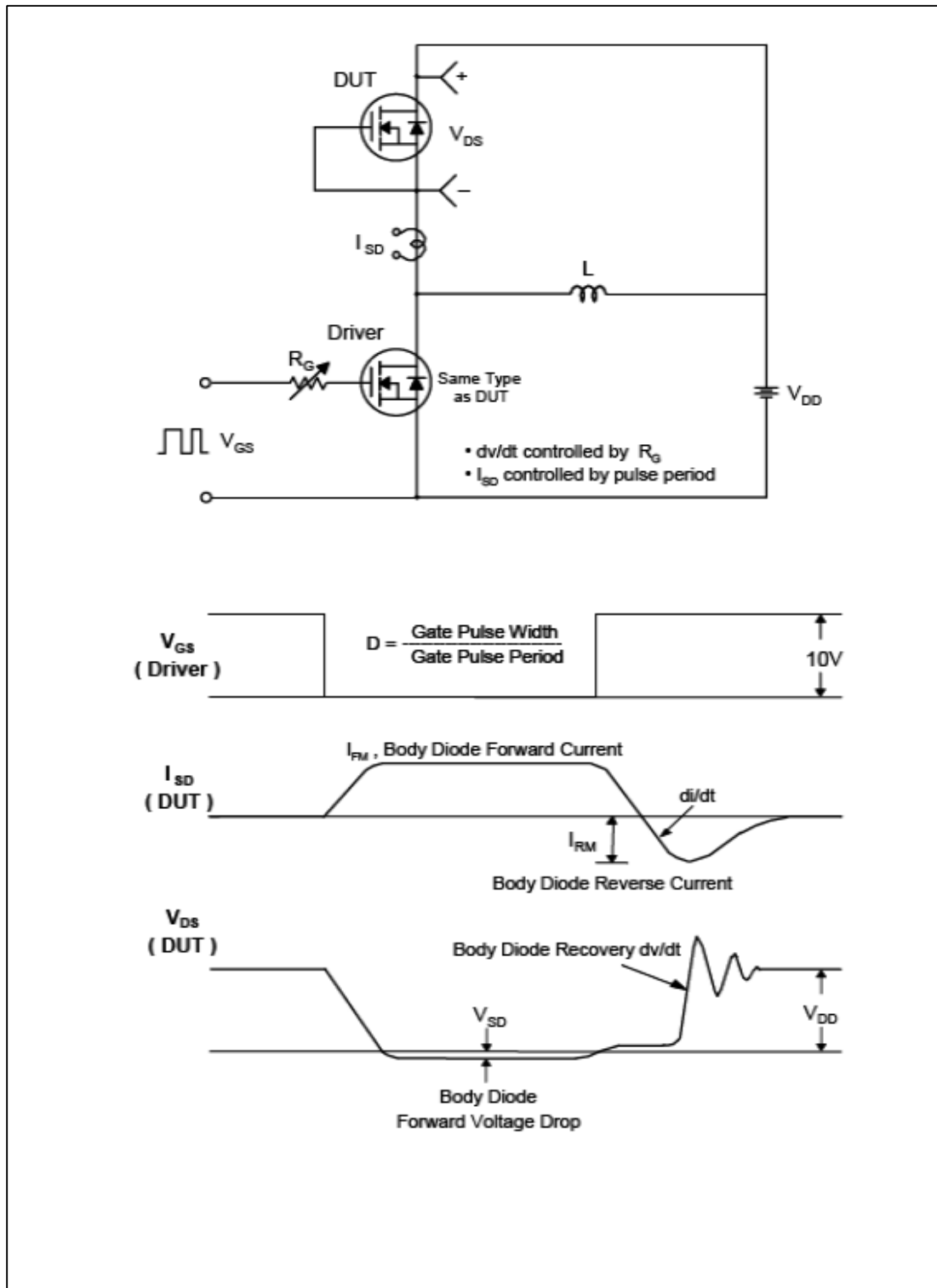
**Fig.10 Gate Test Circuit & Waveform**



**Fig.11 Resistive Switching Test Circuit & Waveform**



**Fig.12 Unclamped Inductive Switching Test Circuit & Waveform**



**Fig.13 Peak Diode Recovery  $dv/dt$  Test Circuit & Waveform**

**IPAK Package Dimension**

