

Silicon N-Channel MOSFET

Features

- 9A,500V, $R_{DS(on)}$ (Max0.75 Ω)@ $V_{GS}=10V$
- Ultra-low Gate charge(Typical 28nC)
- Fast Switching Capability
- 100%Avalanche Tested
- Maximum Junction Temperature Range(150 $^{\circ}C$)

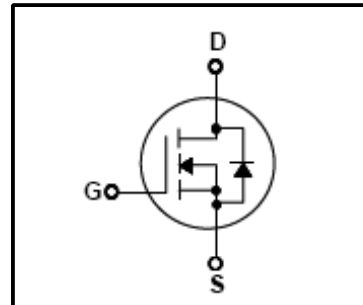

General Description

This Power MOSFET is produced using Winsemi's advanced planar stripe, DMOS technology. This latest technology has been especially designed to minimize on-state resistance, have a high rugged avalanche characteristics. This devices is specially well suited for high efficiency switch model power supplies, power factor correction and half bridge and full bridge resonant topology line a electronic lamp ballast.

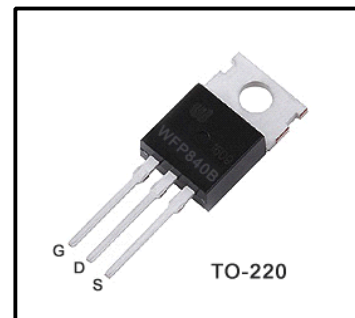

Absolute Maximum Ratings

Symbol	Parameter	Value	Units
V_{DSS}	Drain Source Voltage	500	V
I_D	Continuous Drain Current(@ $T_c=25^{\circ}C$)	9	A
	Continuous Drain Current(@ $T_c=100^{\circ}C$)	5.4	A
I_{DM}	Drain Current Pulsed (Note1)	36	A
V_{GS}	Gate to Source Voltage	± 30	V
E_{AS}	Single Pulsed Avalanche Energy (Note2)	360	mJ
E_{AR}	Repetitive Avalanche Energy (Note1)	13.5	mJ
dv/dt	Peak Diode Recovery dv /dt (Note3)	4.5	V/ ns
P_D	Total Power Dissipation(@ $T_c=25^{\circ}C$)	135	W
	Derating Factor above 25 $^{\circ}C$	1.07	W/ $^{\circ}C$
T_J, T_{stg}	Junction and Storage Temperature	-55~150	$^{\circ}C$
T_L	Channel Temperature	300	$^{\circ}C$

Thermal Characteristics

Symbol	Parameter	Value			Units
		Min	Typ	Max	
R_{QJC}	Thermal Resistance , Junction -to -Case	-	-	0.93	$^{\circ}C/W$
R_{QCS}	Thermal Resistance , Case-to-Sink	-	0.5	-	$^{\circ}C/W$
R_{QJA}	Thermal Resistance , Junction-to -Ambient	-	-	62.5	$^{\circ}C/W$

Electrical Characteristics(Tc=25°C)

Characteristics	Symbol	Test Condition	Min	Type	Max	Unit	
Gate leakage current	I _{GSS}	V _{GS} =±30V,V _{DS} =0V	-	-	±100	nA	
Gate-source breakdown voltage	V _{(BR)GSS}	I _G =±10 μA,V _{DS} =0V	±30	-	-	V	
Drain cut -off current	I _{DSS}	V _{DS} =500V,V _{GS} =0V	-	-	1	μA	
		V _{DS} =400V,TC=125°C			10	μA	
Drain -source breakdown voltage	V _{(BR)DSS}	I _D =250 μA,V _{GS} =0V	500	-	-	V	
Breakdown voltage Temperature Coefficient	$\Delta BV_{DSS} / \Delta T_J$	I _D =250μA,Referenced to 25°C	-	0.57	-	V/°C	
Gate threshold voltage	V _{GS(th)}	V _{DS} =V _{GS} ,I _D =250 μA	3	-	5	V	
Drain -source ON resistance	R _{DS(ON)}	V _{GS} =10V,I _D =4.5A	-	-	0.75	Ω	
Forward Transconductance	g _{fs}	V _{DS} =40V,I _D =4.5A	-	6.5	-	S	
Input capacitance	C _{iss}	V _{DS} =25V,	-	790	1030	pF	
Reverse transfer capacitance	C _{rss}	V _{GS} =0V,	-	24	30		
Output capacitance	C _{oss}	f=1MHz	-	130	170		
Switching time	Rise time	tr	V _{DD} =250V, I _D =9A R _G =25Ω (Note4,5)	-	65	140	ns
	Turn-on time	ton		-	18	15	
	Fall time	tf		-	64	125	
	Turn-off time	toff		-	93	195	
Total gate charge(gate-source plus gate-drain)	Q _g	V _{DD} =400V, V _{GS} =10V,	-	28	35	nC	
Gate-source charge	Q _{gs}	I _D =9A	-	4	-		
Gate-drain("miller") Charge	Q _{gd}	(Note4,5)	-	15	-		

Source-Drain Ratings and Characteristics(Ta=25°C)

Characteristics	Symbol	Test Condition	Min	Type	Max	Unit
Continuous drain reverse current	I _{DR}	-	-	-	9	A
Pulse drain reverse current	I _{DRP}	-	-	-	36	A
Forward voltage(diode)	V _{DSF}	I _{DR} =9A,V _{GS} =0V	-	-	1.4	V
Reverse recovery time	trr	I _{DR} =9A,V _{GS} =0V,	-	335	-	ns
Reverse recovery charge	Q _{rr}	dI _{DR} / dt =100 A / μs	-	2.95	-	μC

Note 1.Repeativity rating :pulse width limited by junction temperature

2.L=8mH I_{AS}=9A,V_{DD}=50V,R_G=25Ω,Starting T_J=25°C

3.I_{SD}≤9A,di/dt≤200A/us,V_{DD}<BV_{DSS},STARTING T_J=25°C

4.Pulse Test:Pulse Width≤300us,Duty Cycle≤2%

5. Essentially independent of operating temperature.

This transistor is an electrostatic sensitive device

Please handle with caution



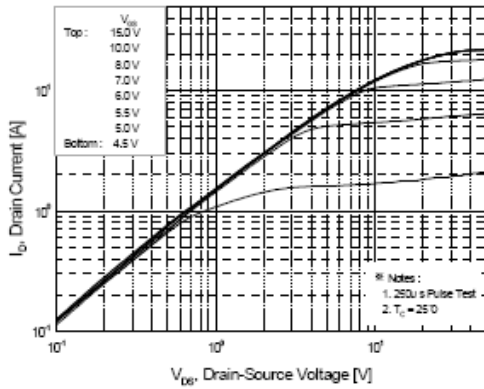

Fig.1 On State Characteristics

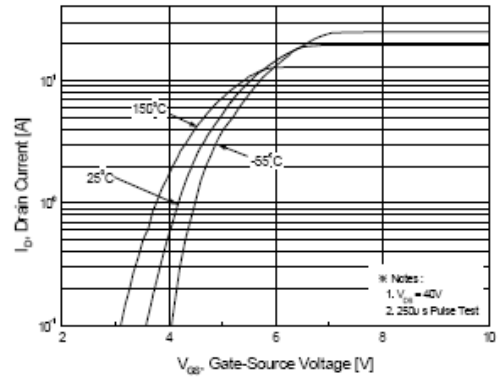

Fig.2 Transfer Characteristics

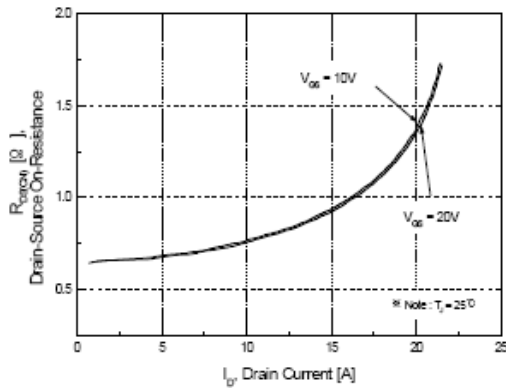

Fig.3 On-Resistance Variation vs Drain Current And Gate Voltage

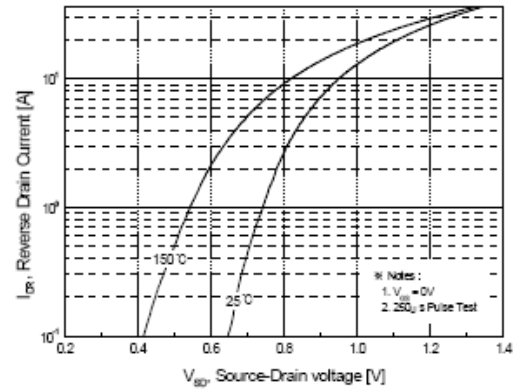

Fig.4 Body Diode Forward Voltage Variation with Source Current and Temperature

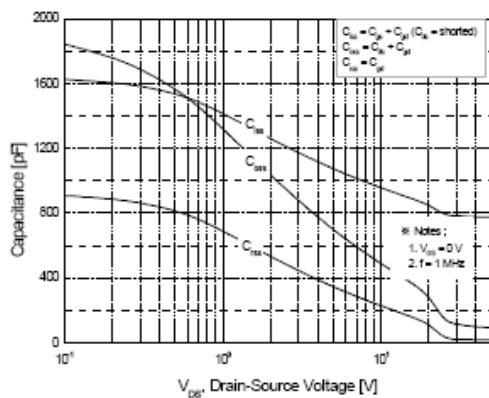

Fig.5 Capacitance Characteristics

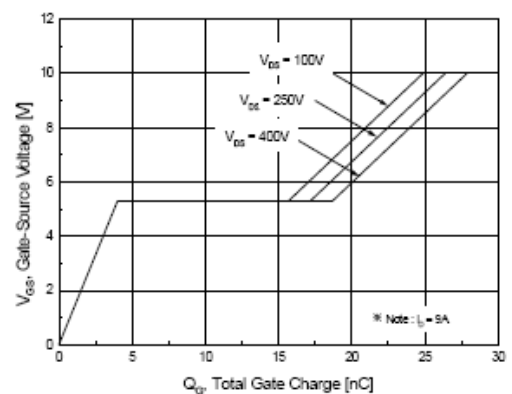

Fig.6 Gate Charge Characteristics

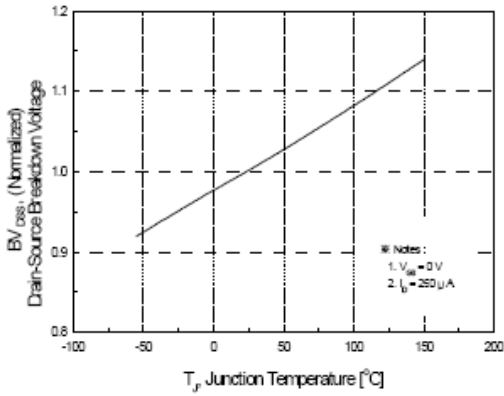

Fig.7 Breakdown Voltage Variation Vs Temperature

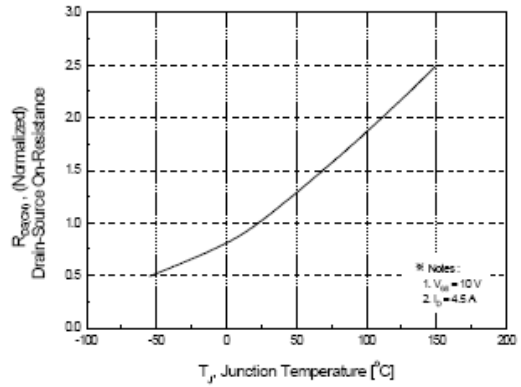

Fig.8 On-Resistance Variation vs. Temperature

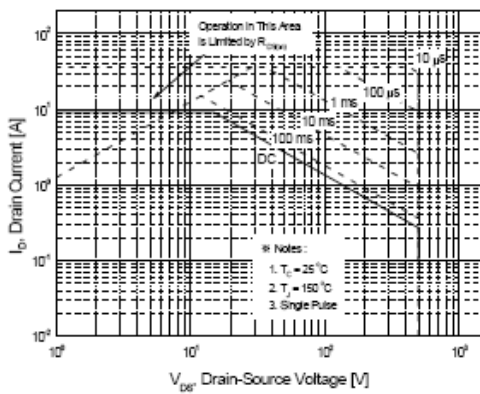

Fig.9 Maximum Safe Operation Area

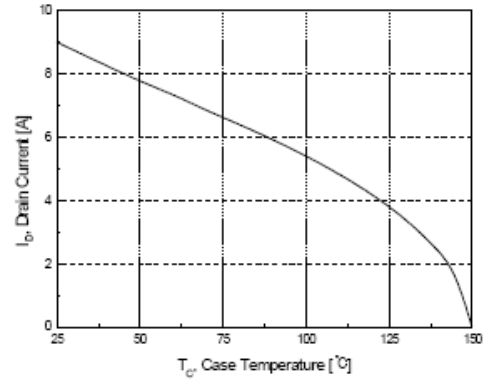

Fig.10 Maximum Drain Current vs Case temperature

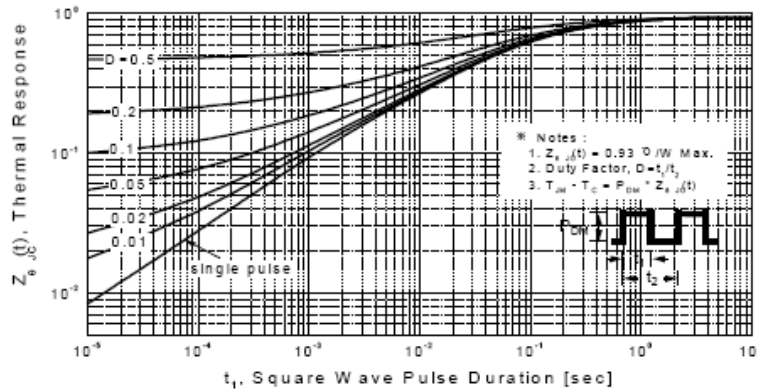

Fig.11 Transient thermal Response Curve

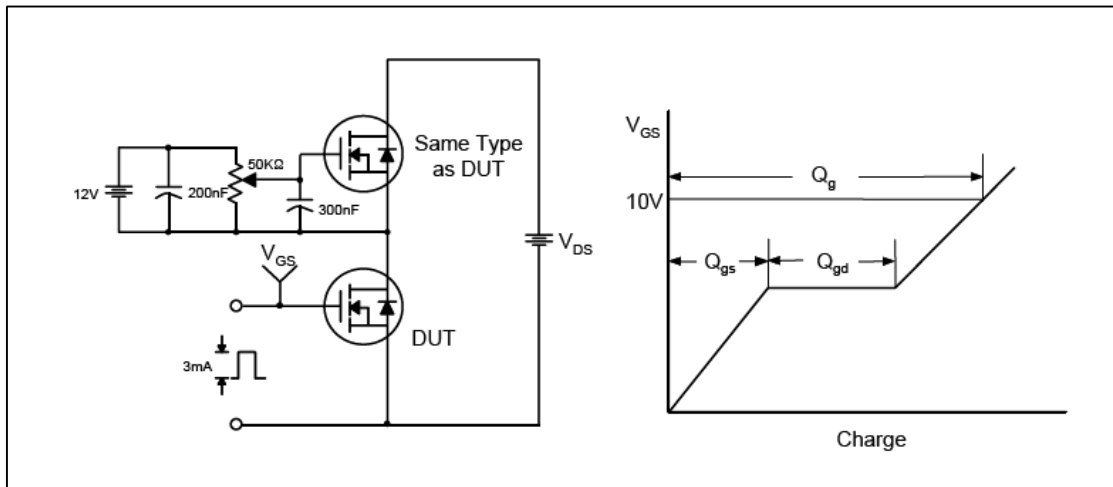

Fig.12 Gate Test circuit & Waveform

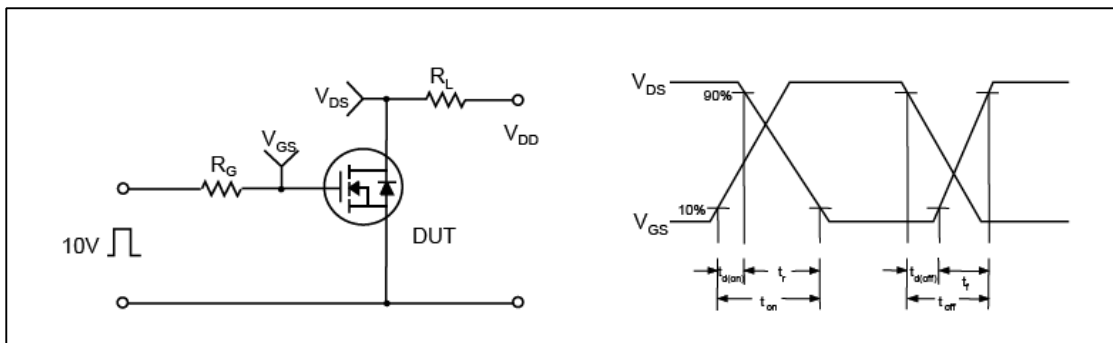

Fig.13 Resistive Switching Test Circuit & Waveform

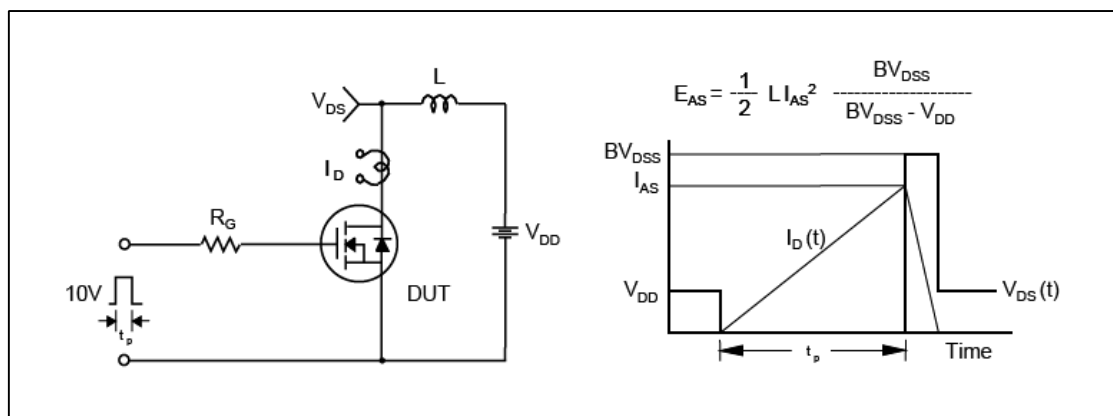

Fig.14 Unclamped Inductive Switching Test Circuit & Waveform

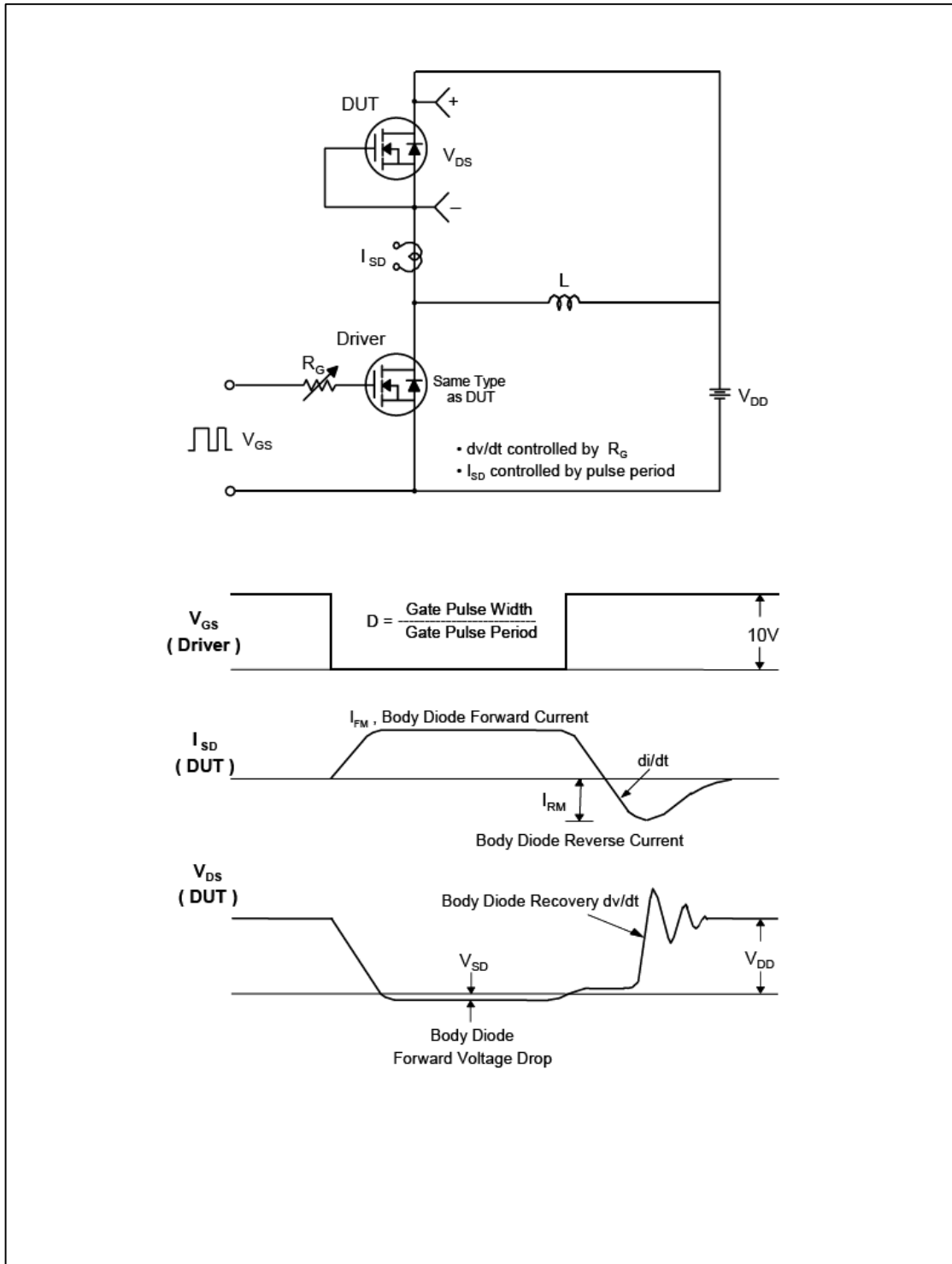

Fig.15 Peak Diode Recovery dv/dt Test Circuit & Waveform

TO-220 Package Dimension

