

> **Features**

- High Speed Switching
- Low On-Resistance
- No Secondary Breakdown
- Low Driving Power
- High Voltage
- $V_{GS} = \pm 30V$ Guarantee
- Repetitive Avalanche Rated

> **Applications**

- Switching Regulators
- UPS
- DC-DC converters
- General Purpose Power Amplifier

> **Outline Drawing**

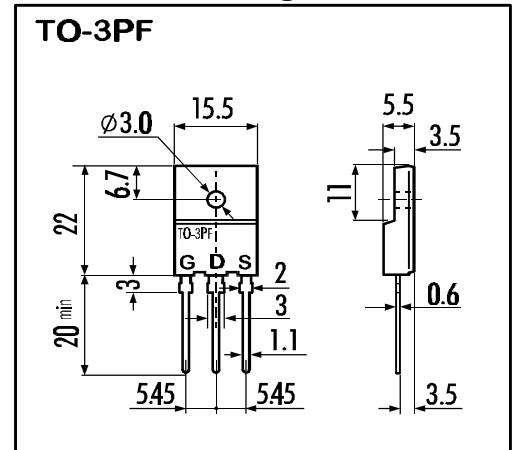

> **Maximum Ratings and Characteristics**

- Absolute Maximum Ratings($T_C=25^\circ C$), unless otherwise specified

| Item | Symbol | Rating | Unit |
|--|---------------|------------|------------|
| Drain-Source-Voltage | V_{DS} | 900 | V |
| Continous Drain Current | I_D | 6 | A |
| Pulsed Drain Current | $I_{D(puls)}$ | 24 | A |
| Gate-Source-Voltage | V_{GS} | ± 30 | V |
| Repetitive or Non-Repetitive ($T_{ch} \leq 150^\circ C$) | I_{AR} | 6 | A |
| Avalanche Energy | E_{AS} | 150,5 | mJ |
| Max. Power Dissipation | P_D | 80 | W |
| Operating and Storage Temperature Range | T_{ch} | 150 | $^\circ C$ |
| | T_{stg} | -55 ~ +150 | $^\circ C$ |

> **Equivalent Circuit**

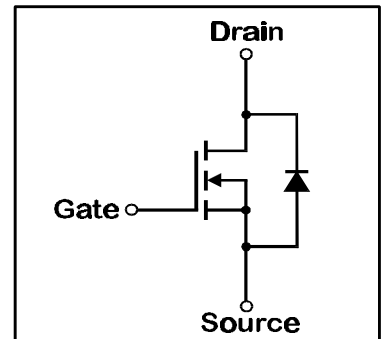

- Electrical Characteristics ($T_C=25^\circ C$), unless otherwise specified

| Item | Symbol | Test conditions | Min. | Typ. | Max. | Unit |
|--|---------------|---|------|------|------|----------|
| Drain-Source Breakdown-Voltage | $V_{(BR)DSS}$ | $I_D=1mA$ $V_{GS}=0V$ | 900 | | | V |
| Gate Threshold Voltage | $V_{GS(th)}$ | $I_D=1mA$ $V_{DS}=V_{GS}$ | 3,5 | 4,0 | 4,5 | V |
| Zero Gate Voltage Drain Current | I_{DSS} | $V_{DS}=900V$ $T_{ch}=25^\circ C$ | | 10 | 500 | μA |
| | | $V_{GS}=0V$ $T_{ch}=125^\circ C$ | | 0,2 | 1,0 | mA |
| Gate Source Leakage Current | I_{GSS} | $V_{GS}=\pm 30V$ $V_{DS}=0V$ | | 10 | 100 | nA |
| Drain Source On-State Resistance | $R_{DS(on)}$ | $I_D=3A$ $V_{GS}=10V$ | | 1,87 | 2,5 | Ω |
| Forward Transconductance | g_{fs} | $I_D=3A$ $V_{DS}=25V$ | | 4 | | S |
| Input Capacitance | C_{iss} | $V_{DS}=25V$ | | 900 | | pF |
| Output Capacitance | C_{oss} | $V_{GS}=0V$ | | 130 | | pF |
| Reverse Transfer Capacitance | C_{rss} | $f=1MHz$ | | 70 | | pF |
| Turn-On-Time t_{on} ($t_{on}=t_{d(on)}+t_r$) | $t_{d(on)}$ | $V_{CC}=600V$ | | 25 | | ns |
| | t_r | $I_D=6A$ | | 80 | | ns |
| Turn-Off-Time t_{off} ($t_{off}=t_{d(off)}+t_f$) | $t_{d(off)}$ | $V_{GS}=10V$ | | 70 | | ns |
| | t_f | $R_{GS}=10 \Omega$ | | 40 | | ns |
| Avalanche Capability | I_{AV} | $L = 100\mu H$ $T_{ch}=25^\circ C$ | 6 | | | A |
| Diode Forward On-Voltage | V_{SD} | $I_F=2I_{DR}$ $V_{GS}=0V$ $T_{ch}=25^\circ C$ | | 1,0 | | V |
| Reverse Recovery Time | t_{rr} | $I_F=I_{DR}$ $V_{GS}=0V$ | | 850 | | ns |
| Reverse Recovery Charge | Q_{rr} | $-di_F/dt=100A/\mu s$ $T_{ch}=25^\circ C$ | | 8,5 | | μC |

- Thermal Characteristics

| Item | Symbol | Test conditions | Min. | Typ. | Max. | Unit |
|--------------------|----------------|-----------------|------|------|------|--------------|
| Thermal Resistance | $R_{th(ch-a)}$ | channel to air | | | 30 | $^\circ C/W$ |
| | $R_{th(ch-c)}$ | channel to case | | | 1,56 | $^\circ C/W$ |

| | | | |
|-------------------|------|----|-----|
| N-channel MOS-FET | | | |
| 900V | 2,5Ω | 6A | 80W |

2SK2653-01R

FAP-IIS Series



> Characteristics

Typical Output Characteristics

$I_D = f(V_{DS})$; 80μs pulse test; $T_{ch} = 25^\circ\text{C}$

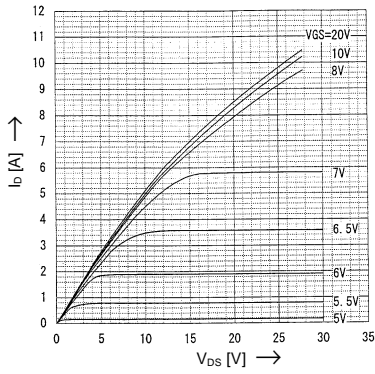

Drain-Source On-State Resistance vs. T_{ch}

$R_{DS(on)} = f(T_{ch})$; $I_D = 3\text{A}$; $V_{GS} = 10\text{V}$

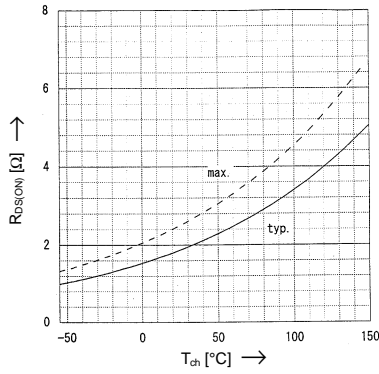

Typical Transfer Characteristics

$I_D = f(V_{GS})$; 80μs pulse test; $V_{DS} = 25\text{V}$; $T_{ch} = 25^\circ\text{C}$

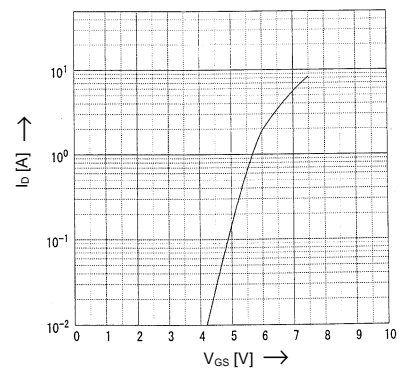

Typical Drain-Source On-State-Resistance vs. I_D

$R_{DS(on)} = f(I_D)$; 80μs pulse test; $T_{ch} = 25^\circ\text{C}$

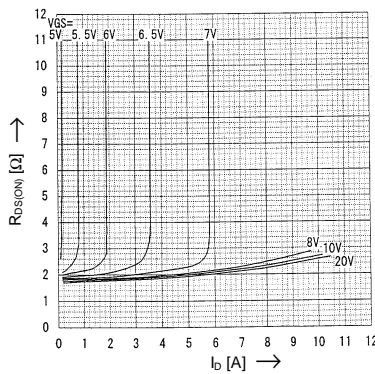

Typical Forward Transconductance vs. I_D

$g_{fs} = f(I_D)$; 80μs pulse test; $V_{DS} = 25\text{V}$; $T_{ch} = 25^\circ\text{C}$

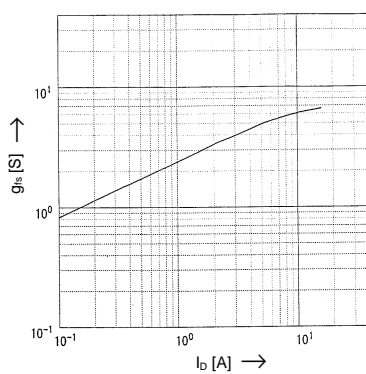

Gate Threshold Voltage vs. T_{ch}

$V_{GS(th)} = f(T_{ch})$; $I_D = 1\text{mA}$; $V_{DS} = V_{GS}$

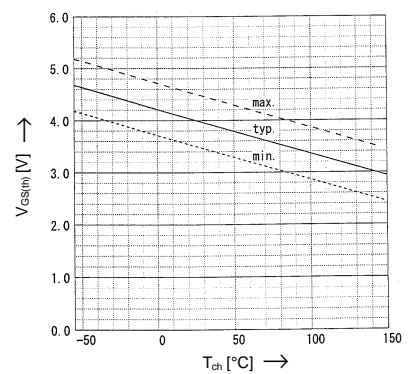

Typical Capacitances vs. V_{DS}

$C = f(V_{DS})$; $V_{GS} = 0\text{V}$; $f = 1\text{MHz}$

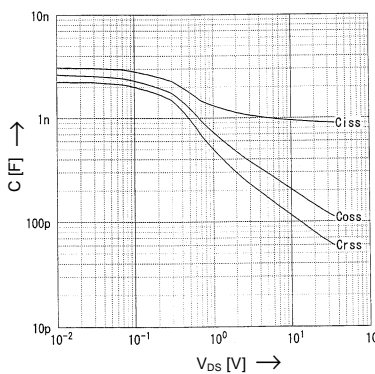

Avalanche Energy Derating

$E_{as} = f(\text{starting } T_{ch})$; $V_{CC} = 90\text{V}$; $I_{AV} = 6\text{A}$

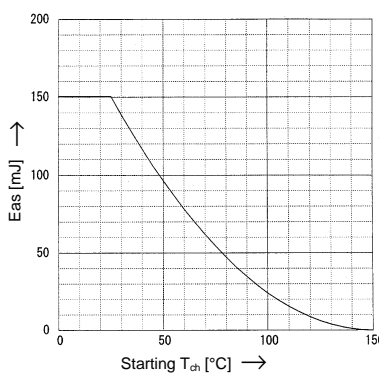

Forward Characteristics of Reverse Diode

$I_F = f(V_{SD})$; 80μs pulse test; $V_{GS} = 0\text{V}$

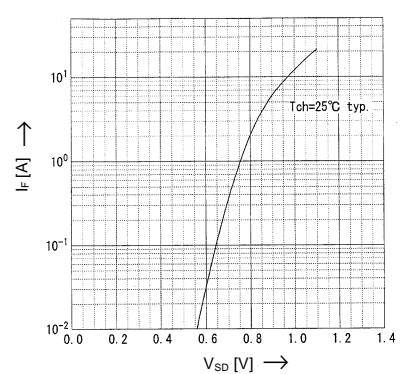

Allowable Power Dissipation vs. T_C

$P_D = f(T_C)$

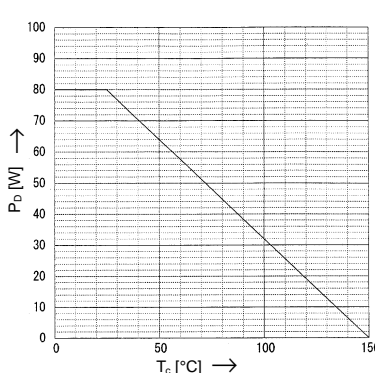

Safe Operation Area

$I_D = f(V_{DS})$; $D = 0.01$; $T_C = 25^\circ\text{C}$

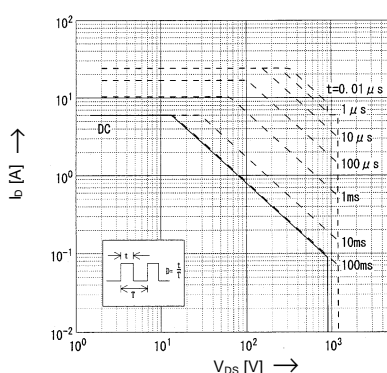

Transient Thermal impedance

$Z_{th(ch-e)} = f(t)$ parameter: $D = t/T$

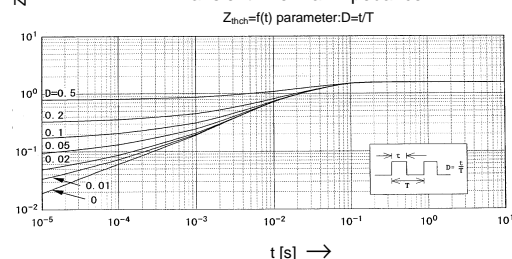

This datasheet has been downloaded from:

www.EEworld.com.cn

Free Download

Daily Updated Database

100% Free Datasheet Search Site

100% Free IC Replacement Search Site

Convenient Electronic Dictionary

Fast Search System

www.EEworld.com.cn