



# 2SK2348

## High-Voltage, High-Speed Switching Applications

### Features

- Low ON resistance, ultrahigh-speed switching.
- High reliability (Adoption of HVP process).

### Package Dimensions

unit: mm

#### 2131-TO-3JML

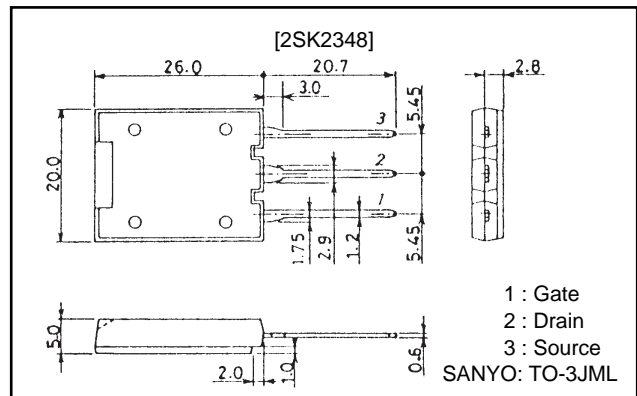

### Specifications

#### Absolute Maximum Ratings at Ta=25°C

Parameter	Symbol	Conditions	Ratings	Unit
Drain-to-Source Voltage	V <sub>DSS</sub>		1200	V
Gate-to-Source Voltage	V <sub>GSS</sub>		±30	V
Drain Current (DC)	I <sub>D</sub>		14	A
Drain Current (pulse)	I <sub>DP</sub>	PW≤10μs, duty cycle≤1%	28	A
Allowable Power Dissipation	P <sub>D</sub>		4.6	W
		T <sub>c</sub> =25°C	160	W
Channel Temperature	T <sub>ch</sub>		150	°C
Storage temperature	T <sub>stg</sub>		-55 to +150	°C

#### Electrical Characteristics at Ta=25°C

Parameter	Symbol	Conditions	Ratings			Unit
			min	typ	max	
D-S Breakdown Voltage	V <sub>(BR)DSS</sub>	I <sub>D</sub> =1mA, V <sub>GS</sub> =0	1200			V
Zero-Gate Voltage Drain Current	I <sub>DSS</sub>	V <sub>DS</sub> =1200V, V <sub>GS</sub> =0			1.0	mA
Gate-to Source Leak Current	I <sub>GSS</sub>	V <sub>GS</sub> =±30V, V <sub>DS</sub> =0			±100	nA
Cutoff Voltage	V <sub>GS(off)</sub>	V <sub>DS</sub> =10V, I <sub>D</sub> =1mA	1.5		3.5	V
Forward Transfer Admittance	y <sub>fs</sub>	V <sub>DS</sub> =20V, I <sub>D</sub> =7A	3.0	6.0		S
Static Drain-to-Source ON-State Resistance	R <sub>DS(on)</sub>	I <sub>D</sub> =7A, V <sub>GS</sub> =10V		1.0	1.5	Ω
Input Capacitance	C <sub>iss</sub>	V <sub>DS</sub> =20V, f=1MHz		3000		pF
Output Capacitance	C <sub>oss</sub>	V <sub>DS</sub> =20V, f=1MHz		500		pF
Reverse Transfer Capacitance	C <sub>rss</sub>	V <sub>DS</sub> =20V, f=1MHz		250		pF

Continued on next page.

# 2SK2348

Continued from preceding page.

Parameter	Symbol	Conditions	Ratings			Unit
			min	typ	max	
Turn-ON Delay Time	$t_{d(on)}$	$I_D=7A, V_{GS}=10V,$ $V_{DD}=200V, R_{GS}=50\Omega$		45		ns
Rise Time	$t_r$			180		ns
Turn-OFF Delay Time	$t_{d(off)}$			850		ns
Fall Time	$t_f$			230		ns
Diode Forward Voltage	$V_{SD}$	$I_S=14A, V_{GS}=0$			1.5	V
Reverse Recovery Time	$t_{rr}$	$I_S=14A, di/dt=100A/\mu s$		0.75	1.5	$\mu s$

## Switching Time Test Circuit

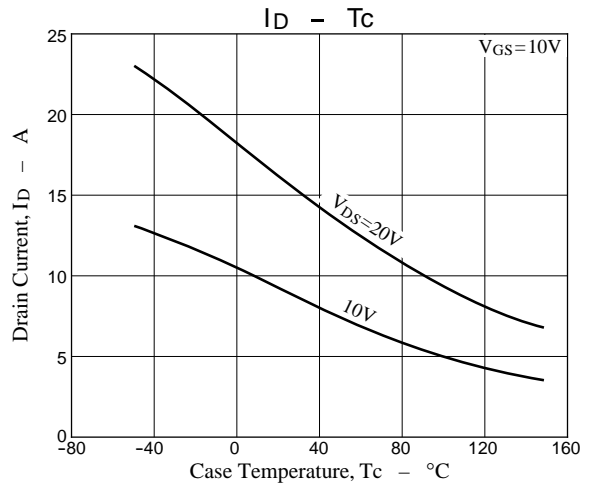
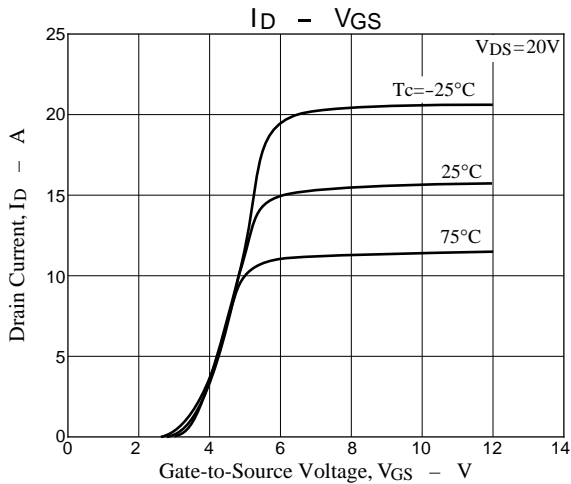
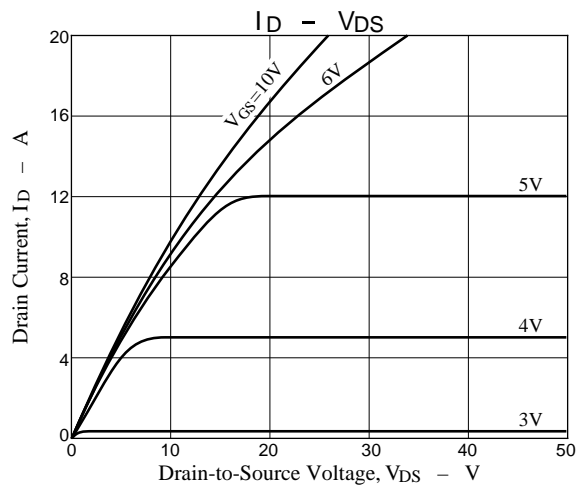
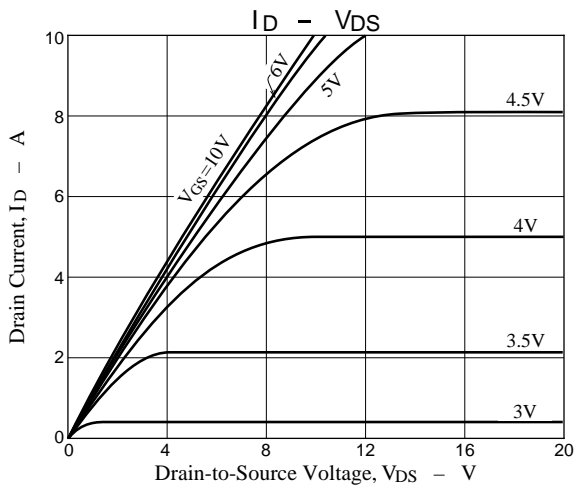
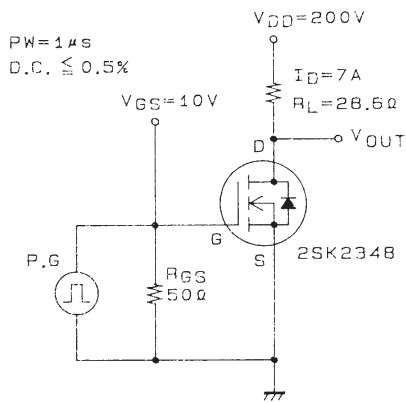

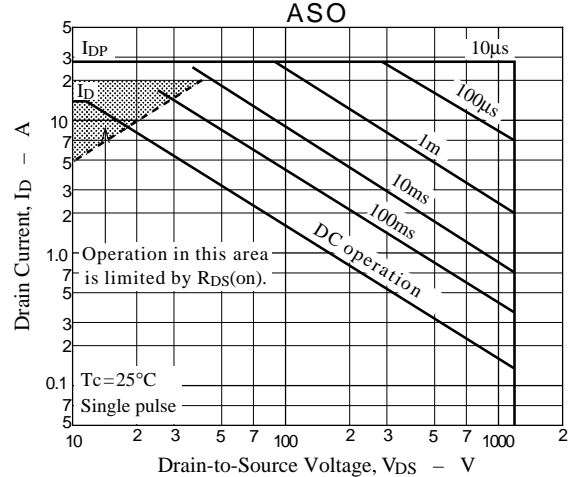
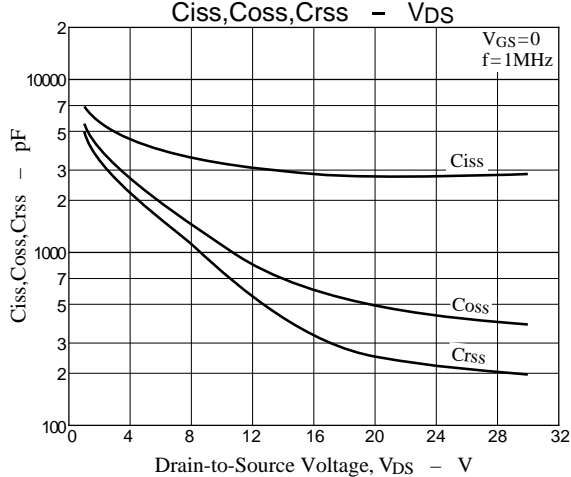
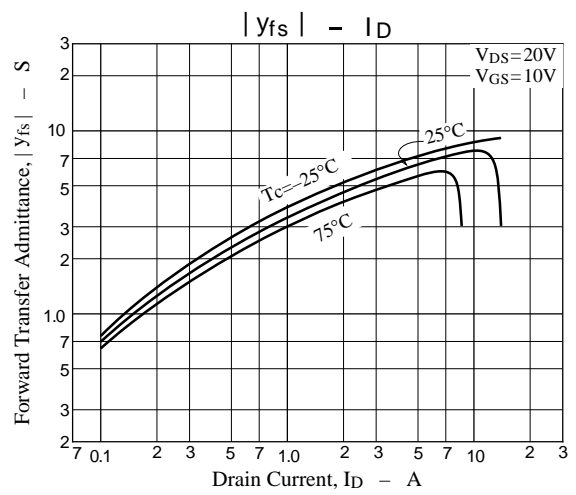
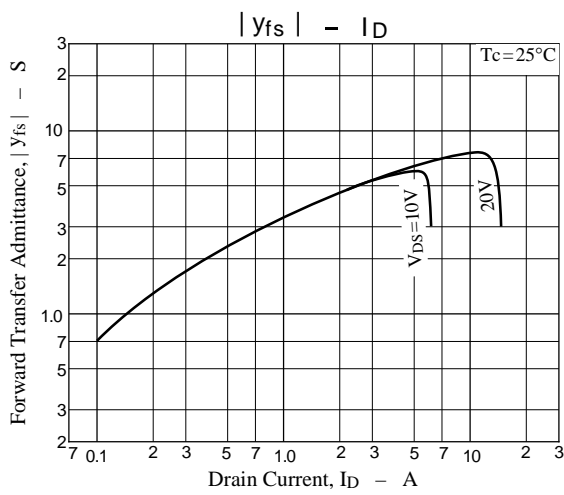
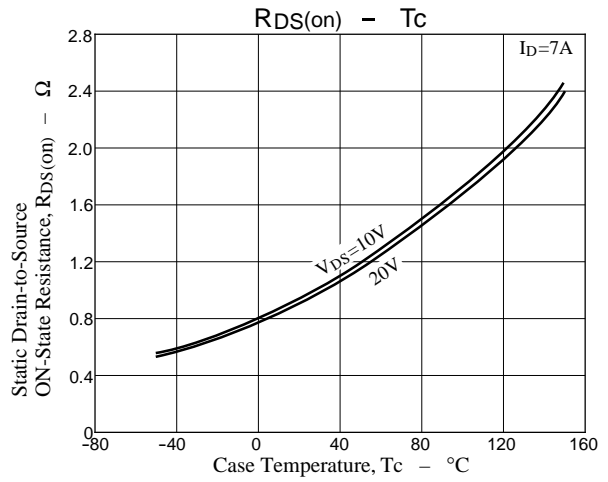
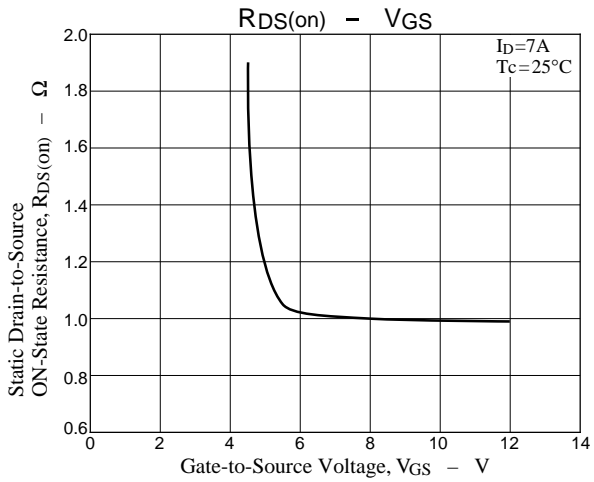
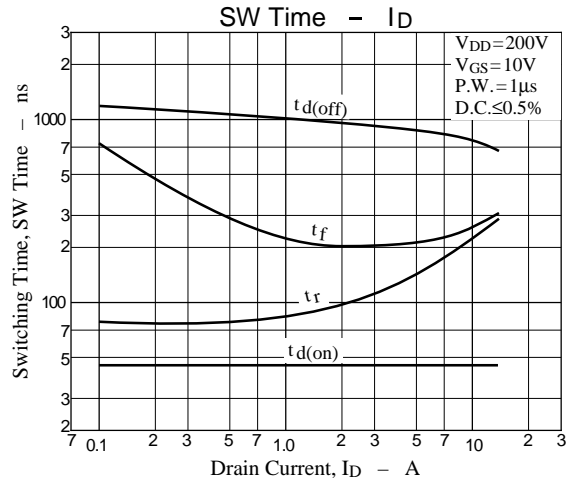
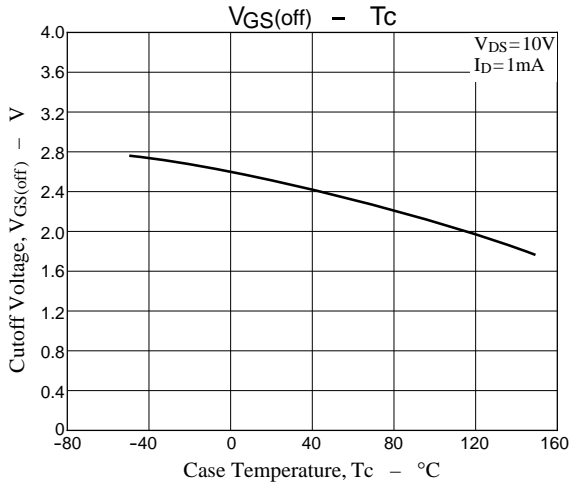

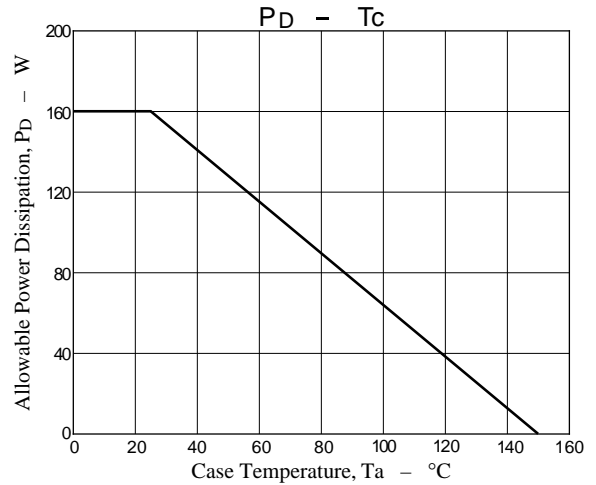
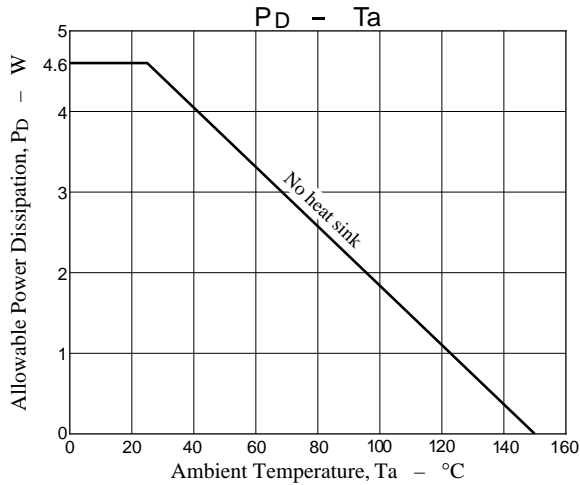

■ No products described or contained herein are intended for use in surgical implants, life-support systems, aerospace equipment, nuclear power control systems, vehicles, disaster/crime-prevention equipment and the like, the failure of which may directly or indirectly cause injury, death or property loss.

■ Anyone purchasing any products described or contained herein for an above-mentioned use shall:

- ① Accept full responsibility and indemnify and defend SANYO ELECTRIC CO., LTD., its affiliates, subsidiaries and distributors and all their officers and employees, jointly and severally, against any and all claims and litigation and all damages, cost and expenses associated with such use:
- ② Not impose any responsibility for any fault or negligence which may be cited in any such claim or litigation on SANYO ELECTRIC CO., LTD., its affiliates, subsidiaries and distributors or any of their officers and employees jointly or severally.

■ Information (including circuit diagrams and circuit parameters) herein is for example only; it is not guaranteed for volume production. SANYO believes information herein is accurate and reliable, but no guarantees are made or implied regarding its use or any infringements of intellectual property rights or other rights of third parties.

This catalog provides information as of July, 1997. Specifications and information herein are subject to change without notice.

**This datasheet has been downloaded from:**

**[www.EEworld.com.cn](http://www.EEworld.com.cn)**

**Free Download**

**Daily Updated Database**

**100% Free Datasheet Search Site**

**100% Free IC Replacement Search Site**

**Convenient Electronic Dictionary**

**Fast Search System**

**[www.EEworld.com.cn](http://www.EEworld.com.cn)**