

SWITCHING N-CHANNEL POWER MOS FET INDUSTRIAL USE

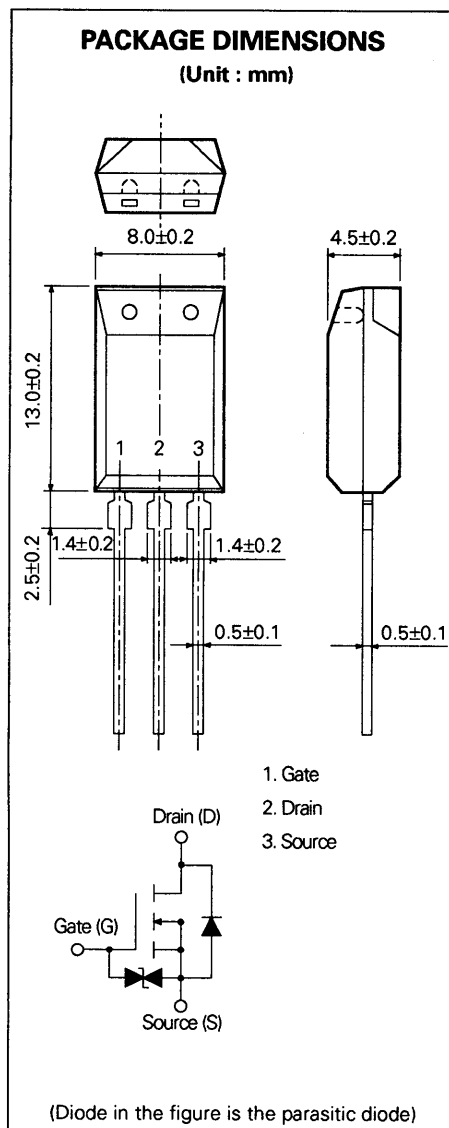

DESCRIPTION

The 2SK2132 is N-channel Power MOS Field Effect Transistor designed for high voltage switching applications.

FEATURES

- Low On-state Resistance
 $R_{DS(on)} = 0.65 \Omega$ MAX. ($V_{GS} = 10$ V, $I_D = 2.0$ A)
- Low C_{iss} $C_{iss} = 300$ pF TYP.
- Built-in G-S Gate Protection Diodes
- High Avalanche Capability Ratings

QUALITY GRADE

Standard

Please refer to "Quality grade on NEC Semiconductor Devices" (Document number IEI-1209) published by NEC Corporation to know the specification of quality grade on the devices and its recommended applications.

ABSOLUTE MAXIMUM RATINGS

Maximum Temperatures

Storage Temperature	-55 to +150	°C
Channel Temperature	150	°C MAX.

Maximum Power Dissipation

Total Power Dissipation ($T_a = 25$ °C)	1.8	W
--	-----	---

Maximum Voltages and Currents ($T_a = 25$ °C)

V_{DSS}	Drain to Source Voltage	180	V
V_{GSS}	Gate to Source Voltage	±20	V
$I_{D(DC)}$	Drain Current (DC)	±4.0	A
$I_{D(pulse)*}$	Drain Current (pulse)	±16	A

Maximum Avalanche Capability Ratings**

I_{AS}	Single Avalanche Current	4.0	A
EAS	Single Avalanche Energy	51.2	mJ

* $PW \leq 10 \mu s$, Duty Cycle $\leq 1\%$

** Starting $T_{ch} = 25$ °C, $R_G = 25 \Omega$, $V_{GS} = 20$ V \rightarrow 0

ELECTRICAL CHARACTERISTICS (T_a = 25 °C)

CHARACTERISTIC	SYMBOL	MIN.	TYP.	MAX.	UNIT	TEST CONDITIONS
Drain to Source On-state Resistance	R _{DS (on)}		0.52	0.65	Ω	V _{GS} = 10 V, I _D = 18 A
Gate to Source Cutoff Voltage	V _{GS (off)}	2.0		4.0	V	V _{DS} = 10 V, I _D = 1 mA
Forward Transfer Admittance	y _{fs}	0.5			S	V _{DS} = 10 V, I _D = 18 A
Drain Leakage Current	I _{DSS}			100	μA	V _{DS} = 500 V, V _{GS} = 0
Gate to Source Leakage Current	I _{GSS}			±10	μA	V _{GS} = ±20 V, V _{DS} = 0
Input Capacitance	C _{iss}		300		pF	V _{DS} = 10 V V _{GS} = 0 f = 1 MHz
Output Capacitance	C _{oss}		170		pF	
Reverse Transfer Capacitance	C _{rss}		50		pF	
Turn-On Delay Time	t _{d (on)}		9.0		ns	V _{GS} = 10 V V _{DD} = 100 V I _D = 2 A, R _G = 10 Ω R _L = 50 Ω
Rise Time	t _r		10		ns	
Turn-Off Delay Time	t _{d (off)}		28		ns	
Fall Time	t _f		12		ns	
Total Gate Charge	Q _G		10		nC	V _{GS} = 10 V I _D = 2 A V _{DD} = 140 V
Gate to Source Charge	Q _{GS}		2.3		nC	
Gate to Drain Charge	Q _{GD}		4.7		nC	
Diode Forward Voltage	V _{F(S-D)}		0.9		V	I _F = 2 A, V _{GS} = 0
Reverse Recovery Time	t _{rr}		180		ns	I _F = 2 A di / dt = 50 A/μs
Reverse Recovery Charge	Q _{rr}		0.5		μC	

Test Circuit 1 : Avalanche Capability

Test Circuit 2 : Switching Time

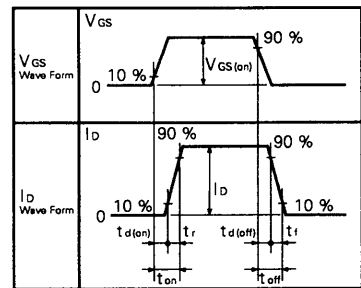
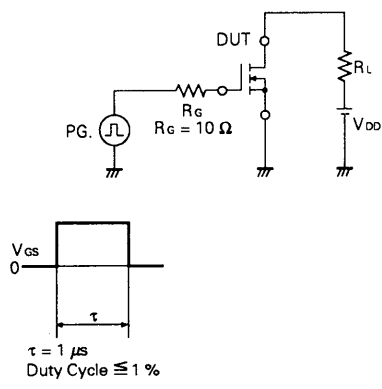
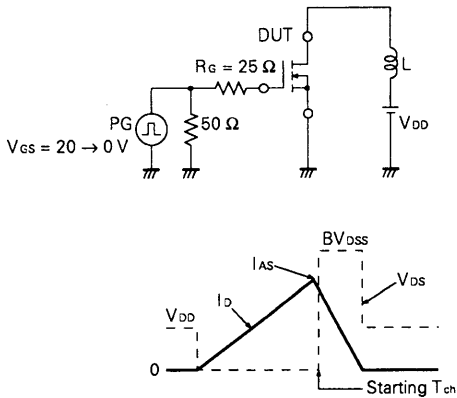

Test Circuit 3 : Gate Charge

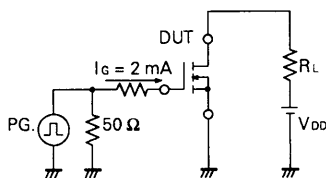

Radial Tape Specification

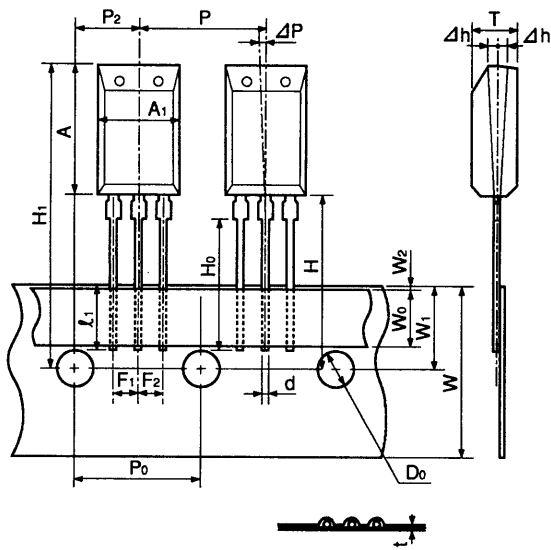

Dimension (unit : mm)

Item		
Component Body Length along Tape	A_1	8.0 ± 0.2
Component Body Height	A	13.0 ± 0.2
Component Body Width	T	4.5 ± 0.2
Component Lead Width Dimension	d	0.5 ± 0.1
Lead Wire Enclosure	l_1	2.5 MIN.
Component Center Pitch	P	12.7 ± 1.0
Feedhole Pitch	P_0	12.7 ± 0.3
Feedhole Center to Center Lead	P_2	6.35 ± 0.5
Component Lead Pitch	F_1, F_2	$2.5 \begin{matrix} + 0.4 \\ - 0.1 \end{matrix}$
Deflection Front or Rear	Δh	± 1.0
Deflection Left or Right	ΔP	± 1.3
Carrier Strip Width	W	$18.0 \begin{matrix} + 1.0 \\ - 0.5 \end{matrix}$
Adhesive Tape Width	W_0	5.0 MIN.
Feedhole Location	W_1	9.0 ± 0.5
Adhesive Tape Position	W_2	0.7 MIN.
Height of Seating Plane	H_0	16.0 ± 0.5
Feedhole to upper of Component	H_1	32.2 MAX.
Feedhole to Bottom of Component	H	20.0 MAX.
Tape Feedhole Diameter	D_0	4.0 ± 0.2
Overall Taped Package Thickness	t	0.7 ± 0.2

TYPICAL CHARACTERISTICS ($T_a = 25^\circ\text{C}$)

DERATING FACTOR OF FORWARD BIAS SAFE OPERATING AREA

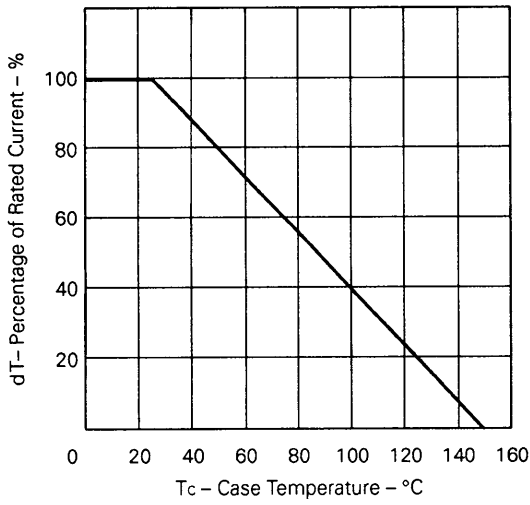

TOTAL POWER DISSIPATION vs. CASE TEMPERATURE

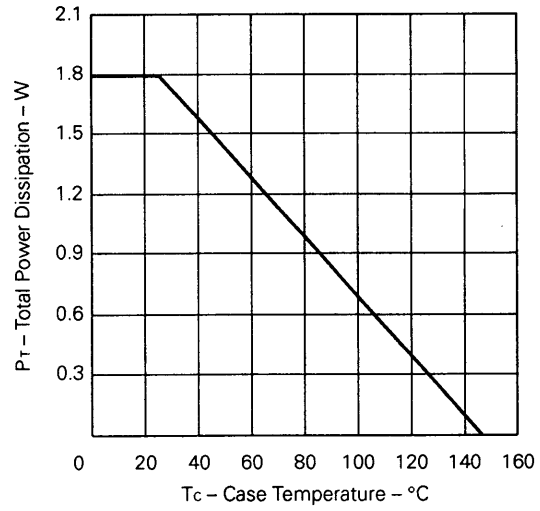

FORWARD BIAS SAFE OPERATING AREA

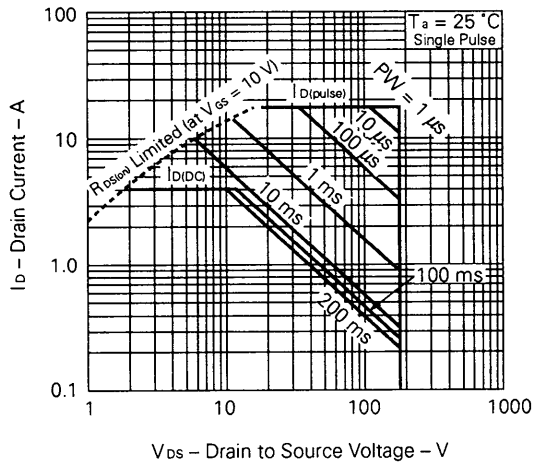

DRAIN CURRENT vs. DRAIN TO SOURCE VOLTAGE

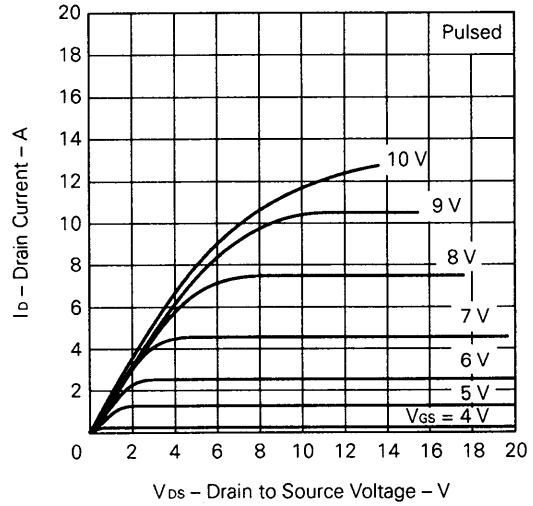

TRANSFER CHARACTERISTICS

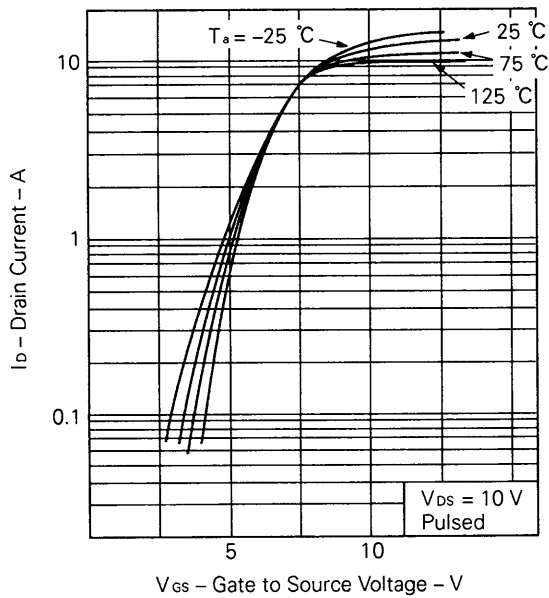

TRANSIENT THERMAL RESISTANCE vs. PULSE WIDTH

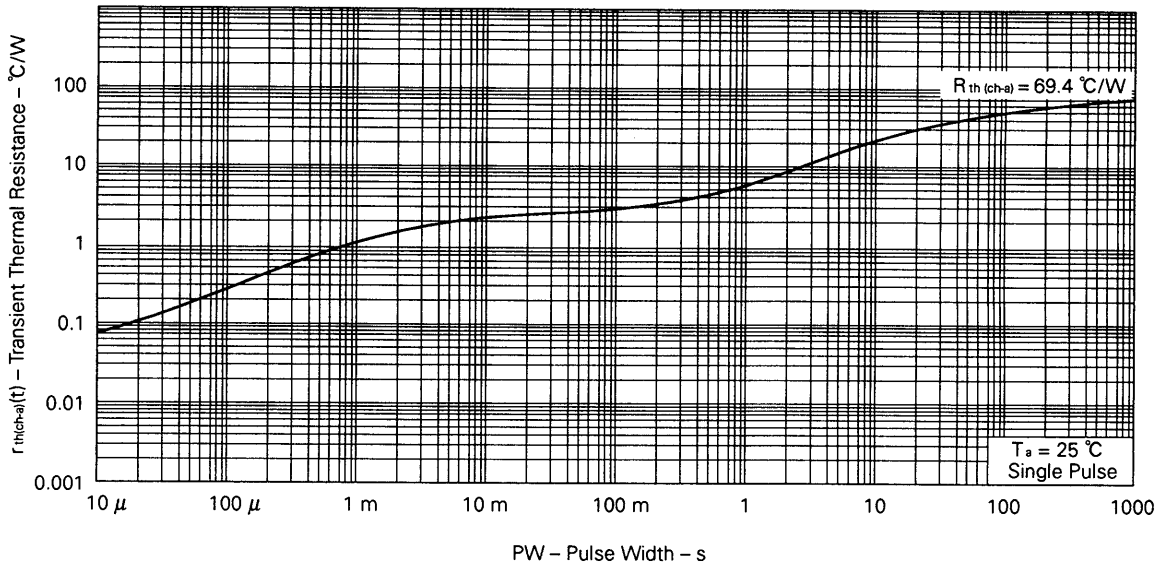

FORWARD TRANSFER ADMITTANCE vs. DRAIN CURRENT

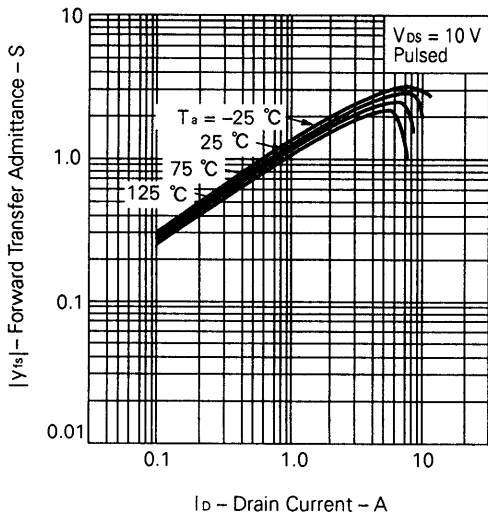

DRAIN TO SOURCE ON-STATE RESISTANCE vs. GATE TO SOURCE VOLTAGE

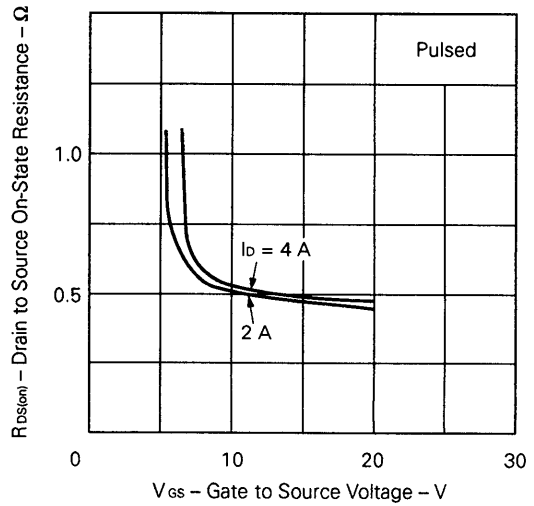

DRAIN TO SOURCE ON-STATE RESISTANCE vs. DRAIN CURRENT

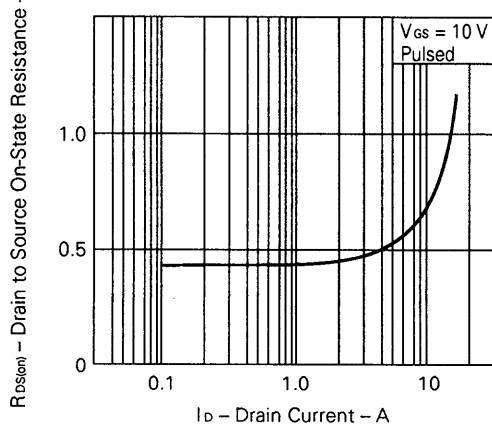

GATE TO SOURCE CUTOFF VOLTAGE vs. CHANNEL TEMPERATURE

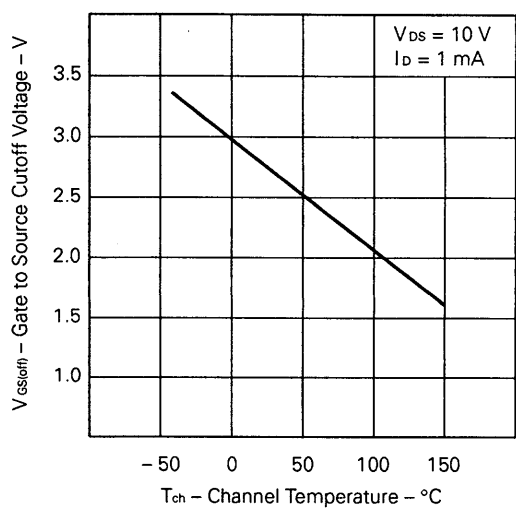

DRAIN TO SOURCE ON - STATE RESISTANCE vs. CHANNEL TEMPERATURE

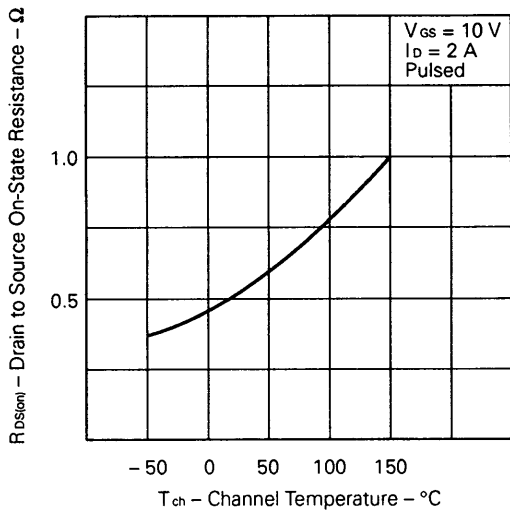

SOURCE TO DRAIN DIODE FORWARD VOLTAGE

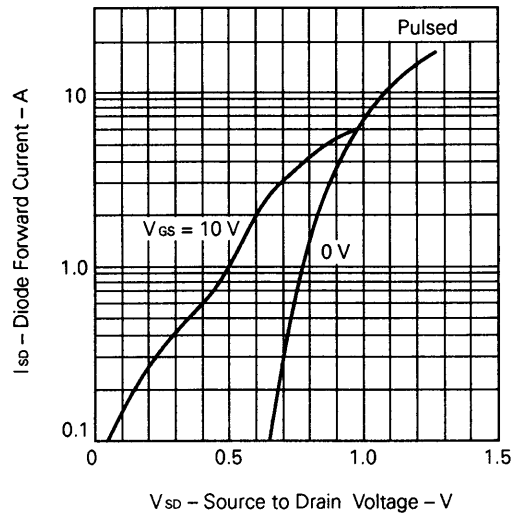

CAPACITANCE vs. DRAIN TO SOURCE VOLTAGE

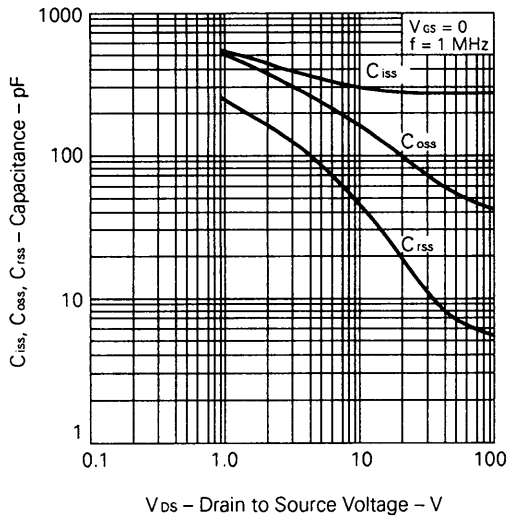

SWITCHING CHARACTERISTICS

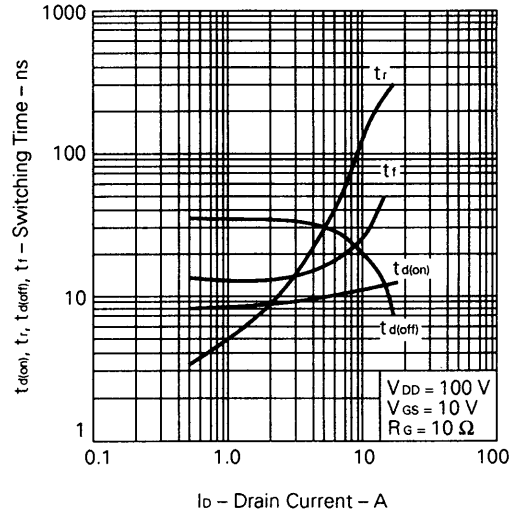

DYNAMIC INPUT CHARACTERISTICS

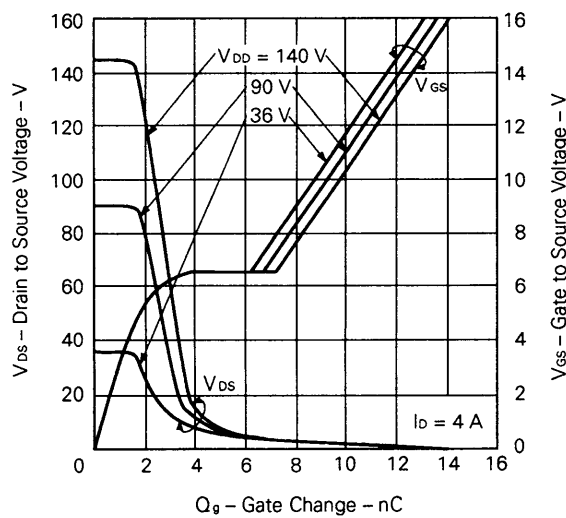

REVERSE RECOVERY TIME vs. DIODE FORWARD CURRENT

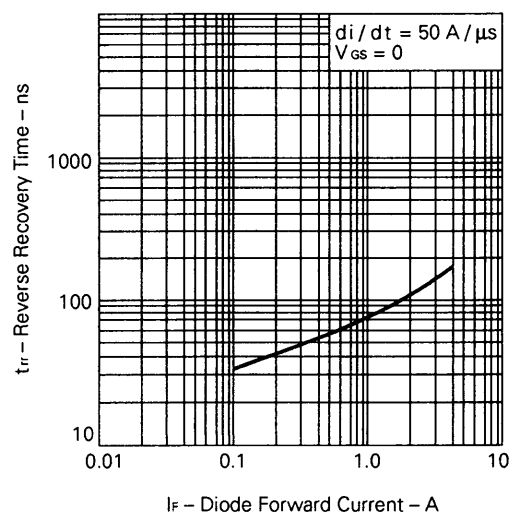

SINGLE AVALANCE CURRENT vs. INDUCTIVE LOAD

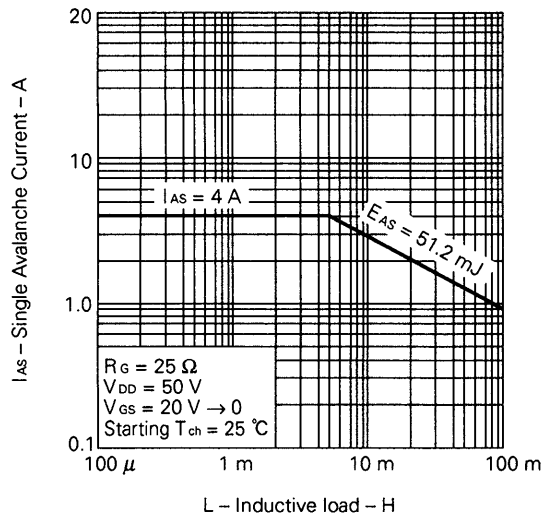

SINGLE AVALANCHE ENERGY vs. STARTING CHANNEL TEMPERATURE

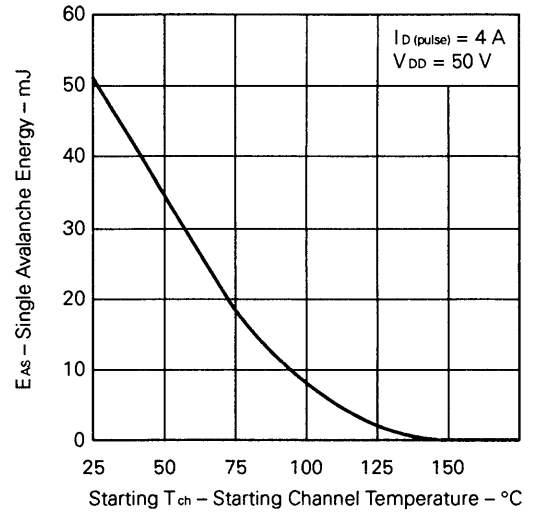

[MEMO]

No part of this document may be copied or reproduced in any form or by any means without the prior written consent of NEC Corporation. NEC Corporation assumes no responsibility for any errors which may appear in this document.

NEC Corporation does not assume any liability for infringement of patents, copyrights or other intellectual property rights of third parties by or arising from use of a device described herein or any other liability arising from use of such device. No license, either express, implied or otherwise, is granted under any patents, copyrights or other intellectual property rights of NEC Corporation or others.

The devices listed in this document are not suitable for use in aerospace equipment, submarine cables, nuclear reactor control systems and life support systems. If customers intend to use NEC devices for above applications or they intend to use "Standard" quality grade NEC devices for applications not intended by NEC, please contact our sales people in advance.

Application examples recommended by NEC Corporation.

Standard: Computer, Office equipment, Communication equipment, Test and Measurement equipment, Machine tools, Industrial robots, Audio and Visual equipment, Other consumer products, etc.

Special: Automotive and Transportation equipment, Traffic control systems, Antidisaster systems, Anticrime systems, etc.