

## N-CHANNEL SILICON POWER MOSFET

## FAP-IIA SERIES

### ■ Features

- High speed switching
- Low on-resistance
- No secondary breakdown
- Low driving power
- High voltage
- $V_{GS}=\pm 30V$  Guarantee
- Avalanche-proof

### ■ Applications

- Switching regulators
- UPS
- DC-DC converters
- General purpose power amplifier

### ■ Outline Drawings

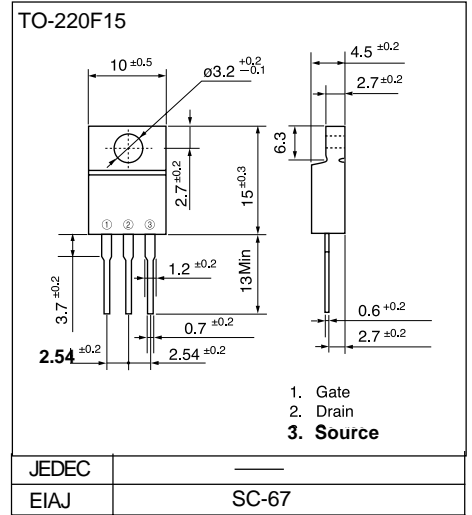

### ■ Maximum ratings and characteristics

#### ● Absolute maximum ratings ( $T_c=25^\circ C$ unless otherwise specified)

Item	Symbol	Rating	Unit
Drain-source voltage	$V_{DS}$	800	V
Continuous drain current	$I_D$	6	A
Pulsed drain current	$I_{D(puls)}$	24	A
Continuous reverse drain current	$I_{DR}$	6	A
Gate-source peak voltage	$V_{GS}$	$\pm 30$	V
Max. power dissipation	$P_D$	50	W
Operating and storage temperature range	$T_{ch}$	+150	$^\circ C$
	$T_{stg}$	-55 to +150	$^\circ C$

### ■ Equivalent circuit schematic

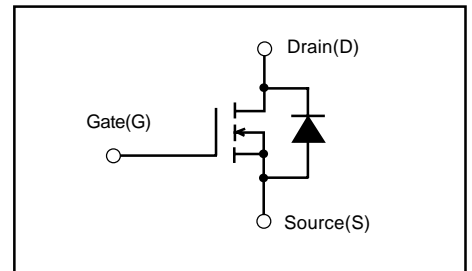

#### ● Electrical characteristics ( $T_c = 25^\circ C$ unless otherwise specified)

Item	Symbol	Test Conditions	Min.	Typ.	Max.	Units	
Drain-source breakdown voltage	$V_{(BR)DSS}$	$I_D=1mA$ $V_{GS}=0V$	800			V	
Gate threshold voltage	$V_{GS(th)}$	$I_D=1mA$ $V_{DS}=V_{GS}$	2.5	3.0	3.5	V	
Zero gate voltage drain current	$I_{DSS}$	$V_{DS}=800V$ $V_{GS}=0V$	$T_{ch}=25^\circ C$		10	500	$\mu A$
			$T_{ch}=125^\circ C$		0.2	1.0	mA
Gate-source leakage current	$I_{GSS}$	$V_{GS}=\pm 30V$ $V_{DS}=0V$		10	100	nA	
Drain-source on-state resistance	$R_{DS(on)}$	$I_D=3A$ $V_{GS}=10V$		1.7	2.1	$\Omega$	
Forward transconductance	$g_{fs}$	$I_D=3A$ $V_{DS}=25V$	3.0	6.5		S	
Input capacitance	$C_{iss}$	$V_{DS}=25V$ $V_{GS}=0V$ $f=1MHz$		1200	1800	pF	
Output capacitance	$C_{oss}$			120	180		
Reverse transfer capacitance	$C_{rss}$			40	60		
Turn-on time $t_{on}$ ( $t_{on}=t_{d(on)}+t_r$ )	$t_{d(on)}$	$V_{CC}=600V$ $R_G=10\Omega$ $I_D=5A$		25	40	ns	
	$t_r$			25	40		
Turn-off time $t_{off}$ ( $t_{off}=t_{d(off)}+t_f$ )	$t_{d(off)}$	$V_{GS}=10V$		85	130		
	$t_f$			45	70		
Avalanche capability	$I_{AV}$	$L=100\mu H$ $T_{ch}=25^\circ C$	6			A	
Diode forward on-voltage	$V_{SD}$	$I_F=2I_{DR}$ $V_{GS}=0V$ $T_{ch}=25^\circ C$		1.1	1.6	V	
Reverse recovery time	$t_{rr}$	$I_F=I_{DR}$ $V_{GS}=0V$		400		ns	
Reverse recovery charge	$Q_{rr}$	$-di/dt=100A/\mu s$ $T_{ch}=25^\circ C$		1.5		$\mu C$	

#### ● Thermal characteristics

Item	Symbol	Test Conditions	Min.	Typ.	Max.	Units
Thermal resistance	$R_{th(ch-a)}$	channel to ambient			62.5	$^\circ C/W$
	$R_{th(ch-c)}$	channel to case			2.5	$^\circ C/W$

Characteristics

Typical output characteristics

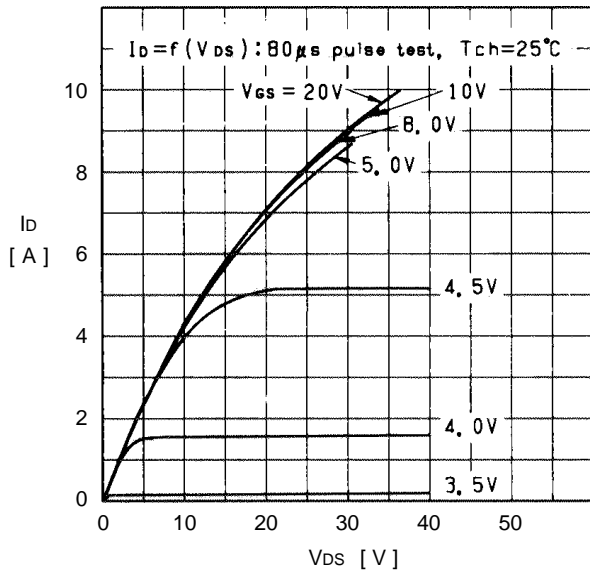

On state resistance vs.  $T_{ch}$

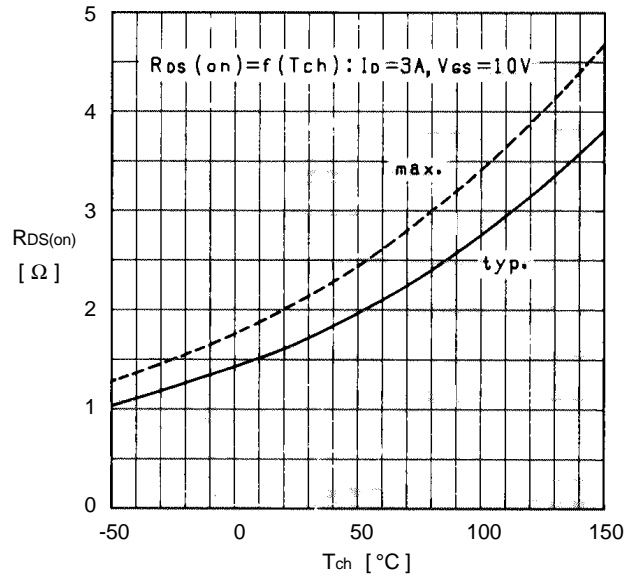

Typical transfer characteristics

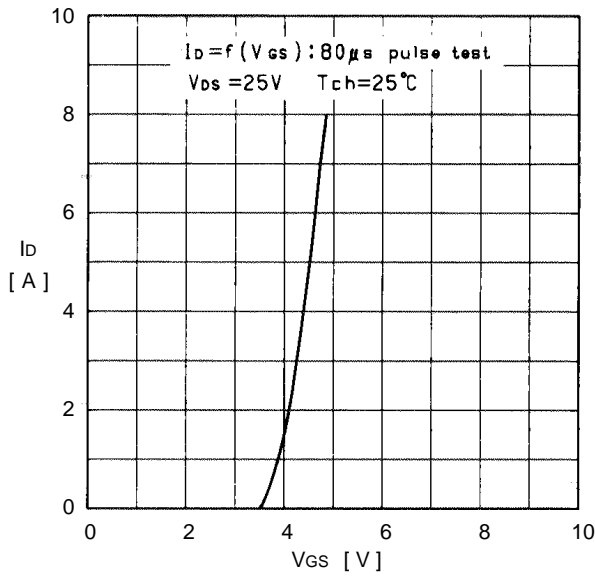

Typical Drain-Source on state resistance vs.  $I_D$

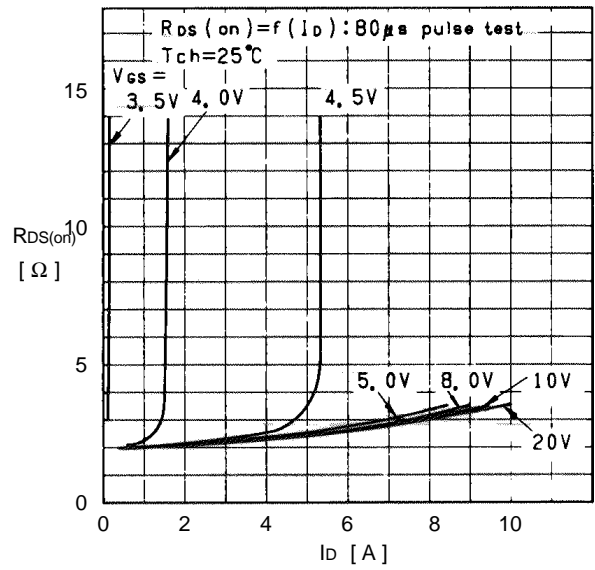

Typical forward transconductance vs.  $I_D$

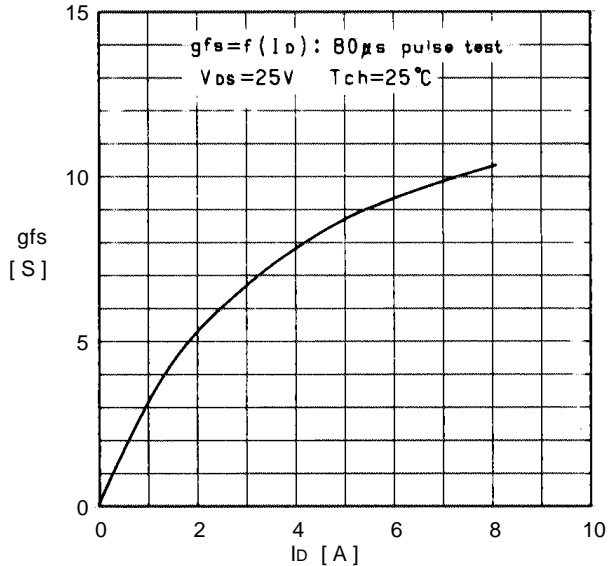

Gate threshold voltage vs.  $T_{ch}$

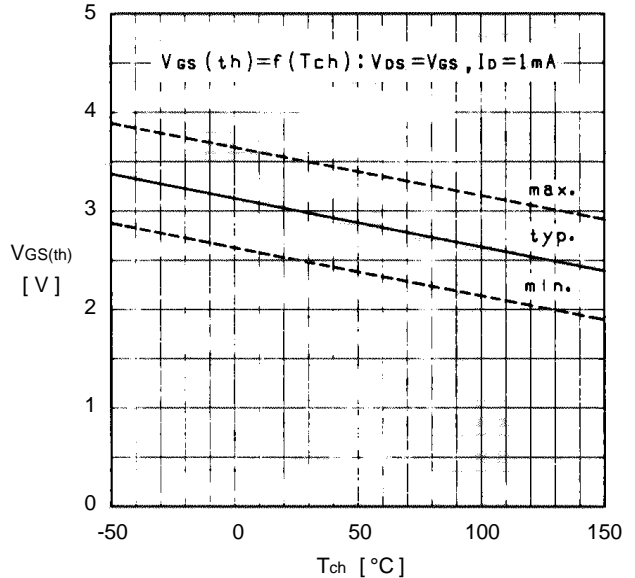

Typical capacitance vs.  $V_{DS}$

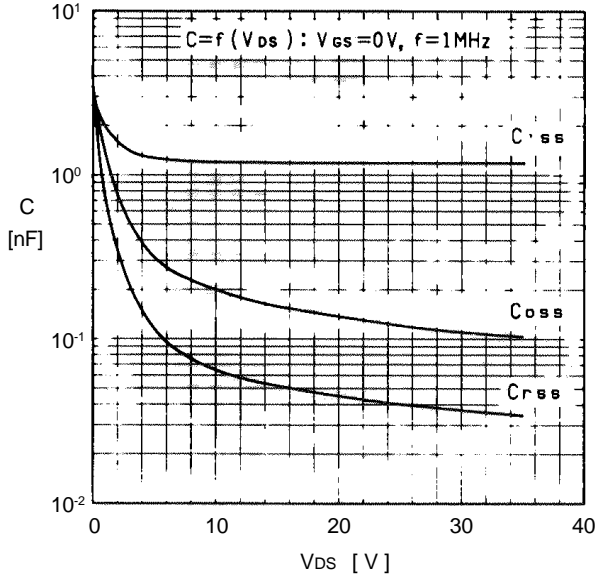

Typical input charge

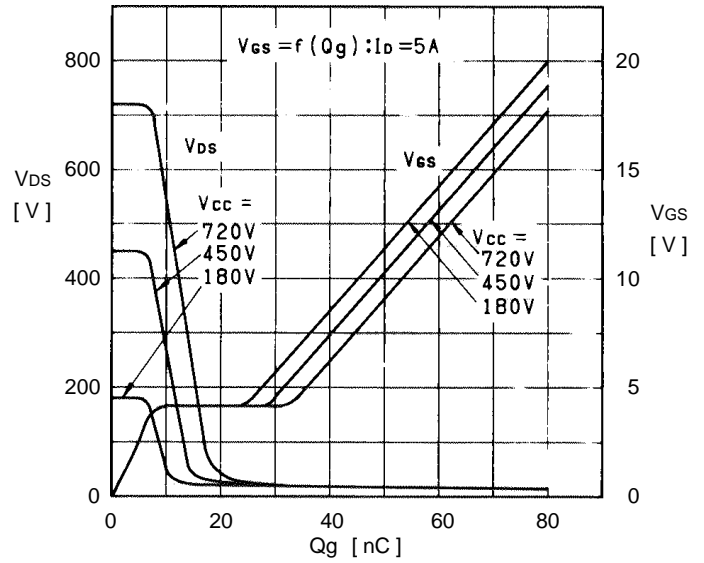

Forward characteristics of reverse diode

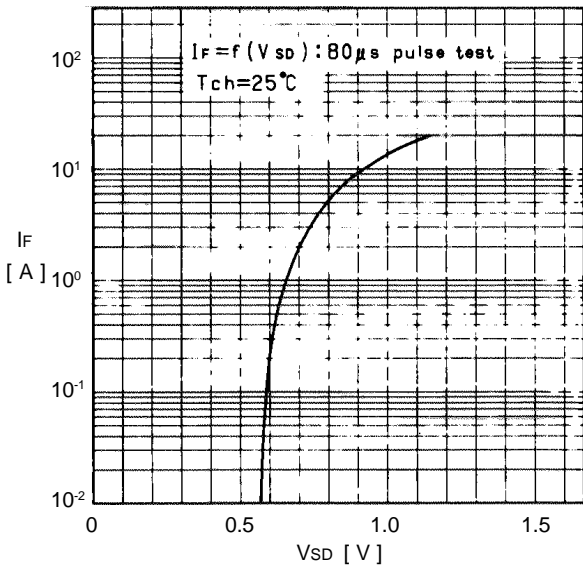

Allowable power dissipation vs.  $T_c$

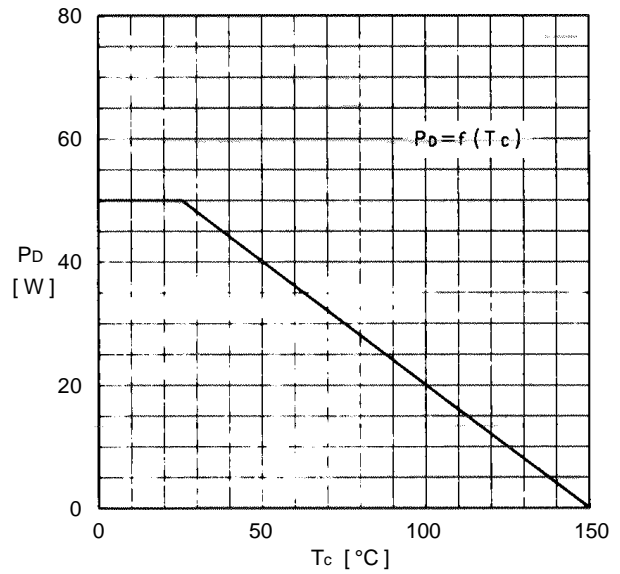

Safe operating area

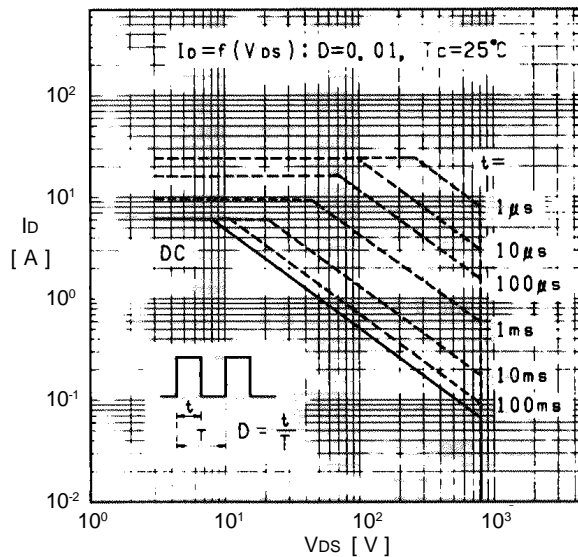

Transient thermal impedance

