

MOS FIELD EFFECT POWER TRANSISTOR 2SK611

FAST SWITCHING N-CHANNEL SILICON POWER MOS FET INDUSTRIAL USE

PACKAGE DIMENSIONS (Unit: mm)

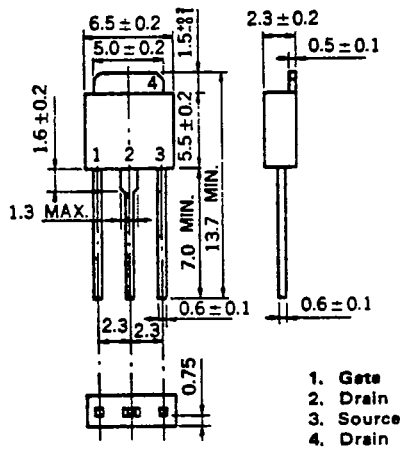

FEATURES

- Suitable for switching power supplies, actuator controls, and pulse circuits.
- Low C_{iss}
- No second breakdown
- 4 V Gate Drive – Logic level –

ABSOLUTE MAXIMUM RATINGS ($T_a = 25^\circ\text{C}$)

Drain to Source Voltage	V_{DS}	100	V
Gate to Source Voltage	V_{GS}	± 20	V
Continuous Drain Current	$I_{D(DC)}$	± 1	A
Peak Drain Current	$I_{D(pulse)^*}$	± 3	A
Total Power Dissipation	P_T^{**}	10	W
Channel Temperature	T_{ch}	150	$^\circ\text{C}$
Storage Temperature	T_{stg}	-55 to +150	$^\circ\text{C}$

* $PW \leq 10 \text{ ms}$, Duty Cycle $\leq 50 \%$

** $T_c = 25^\circ\text{C}$

ELECTRICAL CHARACTERISTICS ($T_a = 25^\circ\text{C}$)

CHARACTERISTIC	SYMBOL	MIN.	TYP.	MAX.	UNIT	TEST CONDITIONS
Drain Leakage Current	I_{DSS}			10	μA	$V_{DS} = 80 \text{ V}$, $V_{GS} = 0$
Gate to Source Leakage Current	I_{GSS}			± 100	nA	$V_{GS} = \pm 15 \text{ V}$, $V_{DS} = 0$
Gate to Source Cutoff Voltage	$V_{GS(off)}$	0.8		3.0	V	$V_{DS} = 10 \text{ V}$, $I_D = 1 \text{ mA}$
Forward Transfer Admittance	$ y_{fs} $	0.2			S	$V_{DS} = 10 \text{ V}$, $I_D = 0.5 \text{ A}$
Drain to Source On-State Resistance	$R_{DS(on)}$		3.0	5.0	Ω	$V_{GS} = 10 \text{ V}$, $I_D = 0.5 \text{ A}$
Drain to Source On-State Resistance	$R_{DS(on)}$		5.0	6.0	Ω	$V_{GS} = 4 \text{ V}$, $I_D = 0.2 \text{ A}$
Input Capacitance	C_{iss}		45		pF	$V_{DS} = 10 \text{ V}$, $V_{GS} = 0$ $f = 1 \text{ MHz}$
Output Capacitance	C_{oss}		25		pF	
Reverse Transfer Capacitance	C_{rss}		5		pF	
Turn-On Delay Time	$t_{d(on)}$		2		ns	$I_D = 0.5 \text{ A}$, $V_{CC} \approx 50 \text{ V}$ $V_{GS(on)} = 10 \text{ V}$ $R_L = 100 \Omega$ $R_{in} = 10 \Omega$
Rise Time	t_r		10		ns	
Turn-Off Delay Time	$t_{d(off)}$		10		ns	
Fall Time	t_f		5		ns	

NEC cannot assume any responsibility for any circuits shown or represent that they are free from patent infringement.

TURN-ON AND TURN-OFF TIME TEST CIRCUIT

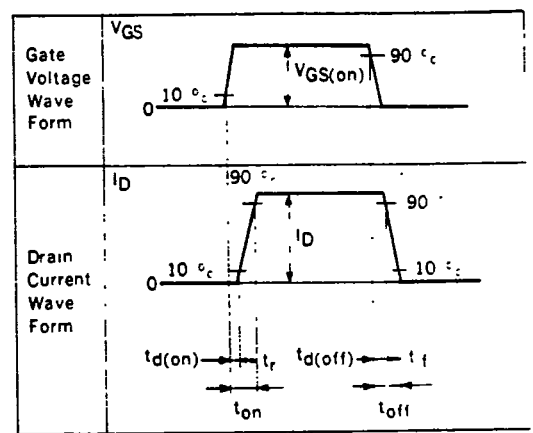
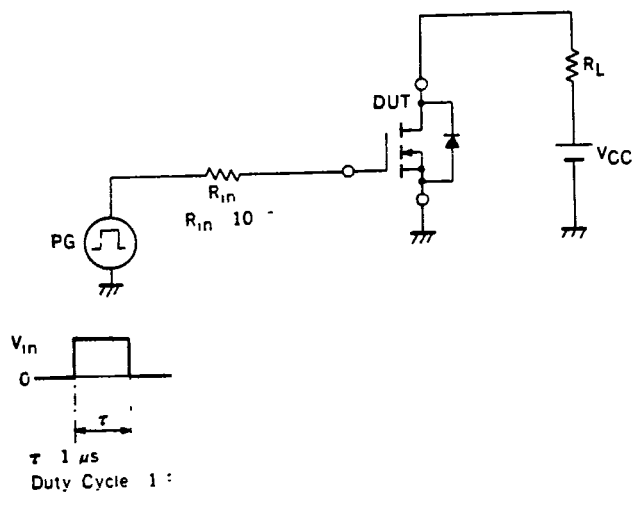

DERATING FACTOR OF FORWARD BIAS SAFE OPERATING AREA

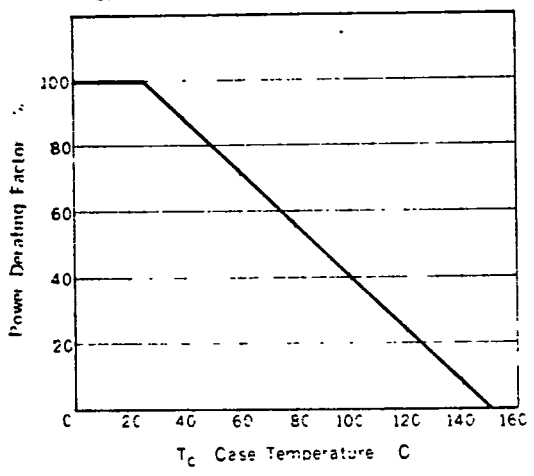

FORWARD BIAS SAFE OPERATING AREA

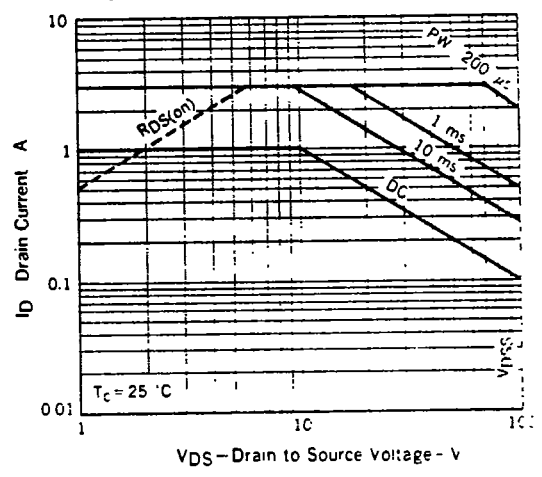

TOTAL POWER DISSIPATION vs. CASE TEMPERATURE

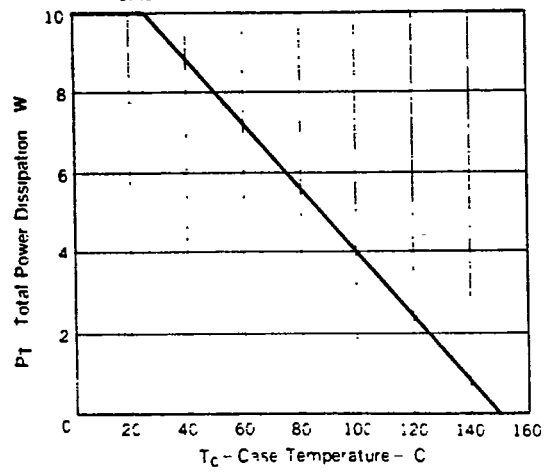

DRAIN CURRENT vs. DRAIN TO SOURCE VOLTAGE

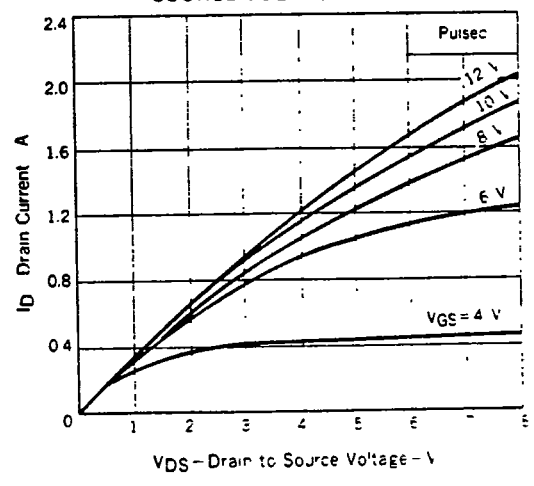

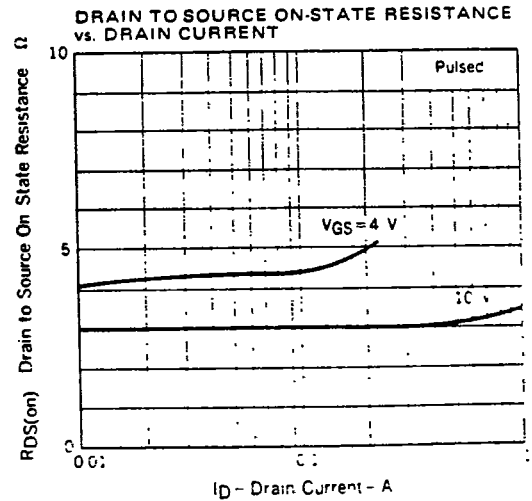
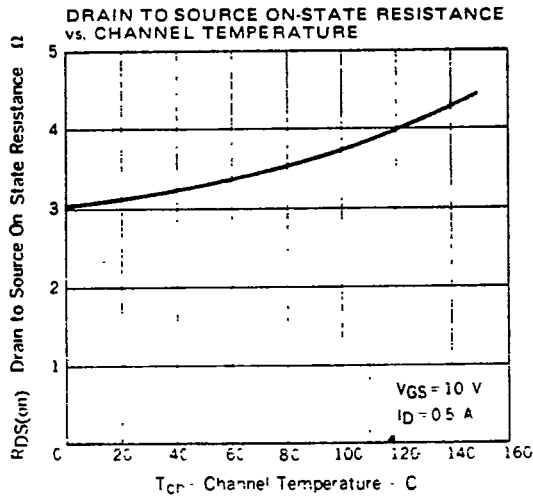
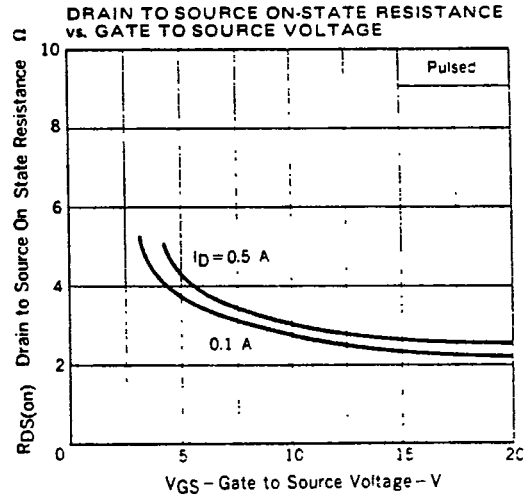
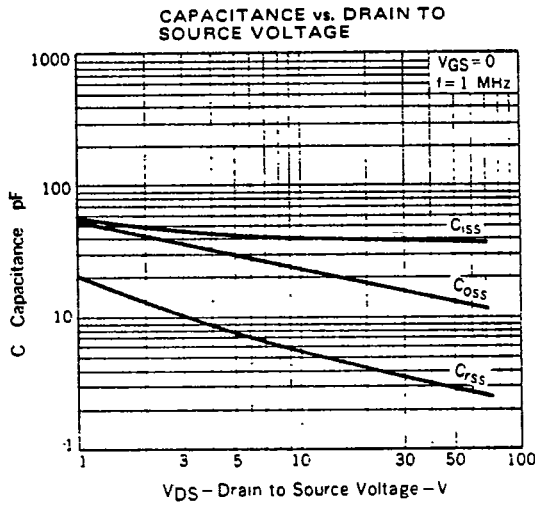
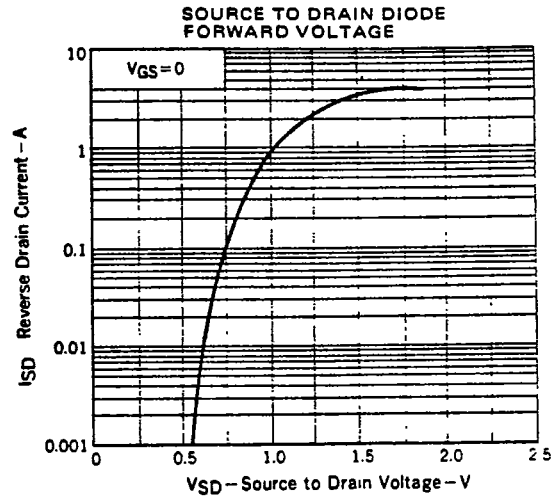
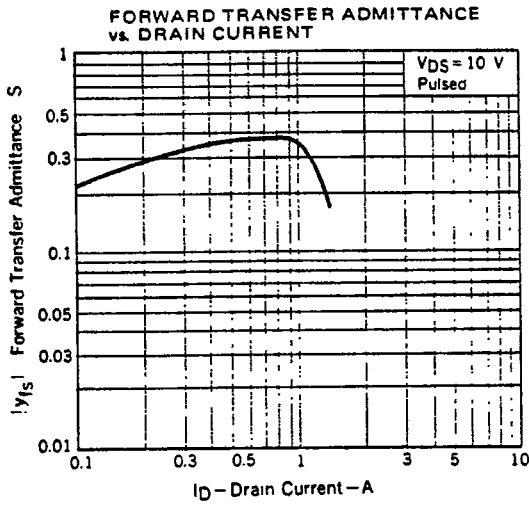

TRANSFER CHARACTERISTIC

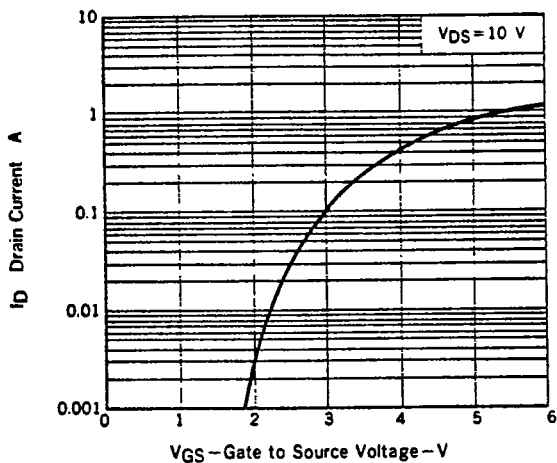

GATE TO SOURCE CUTOFF VOLTAGE vs. CHANNEL TEMPERATURE

