

2SK568

MG8G4GM1

MG8G6EM1

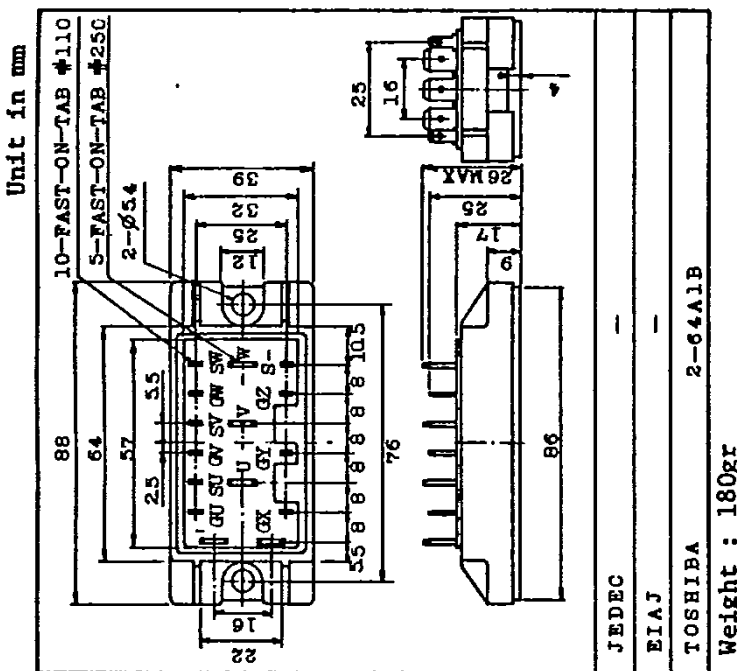
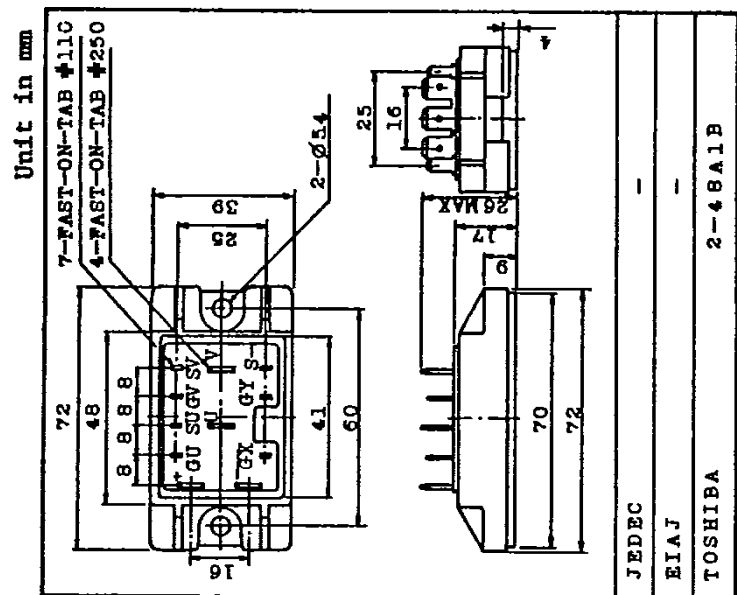
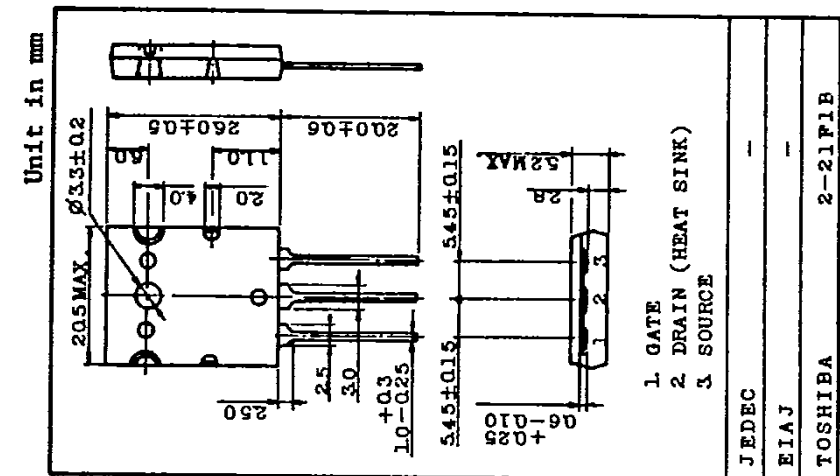

MG8G4GM1

MG8G6EM1

2SK568

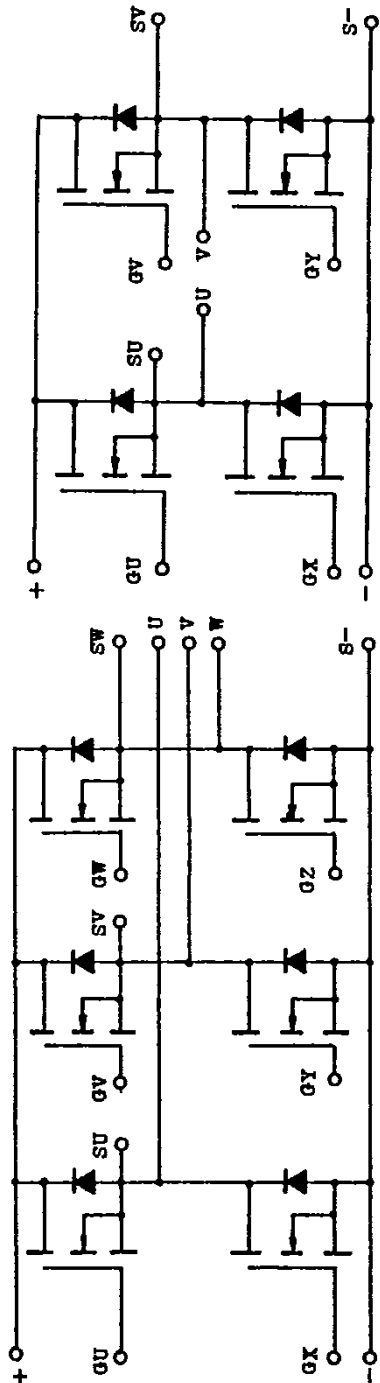
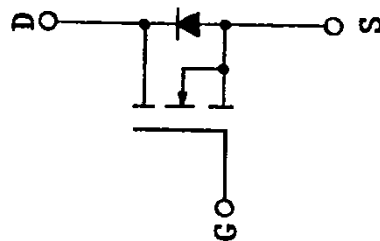



SEMICONDUCTOR

TECHNICAL DATA

查询"MG8G4EM1"供应商

2SK568

MG8G4GM1

MG8G6EM1

MAXIMUM RATINGS (Ta=25°C)

CHARACTERISTIC		SYMBOL	RATING	UNIT
Drain-Source Voltage		V _{DSS}	450	V
Gate-Source Voltage		V _{GSS}	±20	V
Drain Current	DC	I _D	±8	A
	Peak		±16	
Drain Power Dissipation (Tc=25°C)		P _D	100 Note	W
Channel Temperature		T _{ch}	150	°C
Storage Temperature Range		T _{stg}	-40 ~ 125	°C
Isolation Voltage (EXCEPT FOR 2SK568)		V _{Isol}	2500 (AC 1 Minute)	V
Screw Torque		-	30	kg·cm

Note
2SK568
P_D=150W

ELECTRICAL CHARACTERISTICS (Ta=25°C)

CHARACTERISTIC		SYMBOL	TEST CONDITION	MIN.	TYP.	MAX.	UNIT
Gate Leakage Current		I _{GSS}	V _{GS} =±20V, V _{DS} =0	-	-	±100	nA
Drain Cut off Current		I _{DSS}	V _{DS} =450V, V _{GS} =0	-	-	1.0	mA
Drain-Source Breakdown Voltage		V(BR)DSS	I _D =10mA, V _{GS} =0	450	-	-	V
Gate-Source Cut-off Voltage		V _{GS(OFF)}	V _{DS} =10V, I _D =8mA	1.8	2.8	3.8	V
Forward Transfer Admittance		Y _{fs}	V _{DS} =10V, I _D =8A	4.0	6.5	-	S
Drain-Source ON Resistance		R _{DS(ON)}	I _D =8A, V _{GS} =10V	-	0.47	0.75	Ω
Input Capacitance		C _{iss}	V _{DS} =10V, V _{GS} =0, f=1MHz	-	3100	-	pF
Switching Time	Rise Time	t _r	<p> $V_{IN}: t_r, t_f < \epsilon ns$ $D.C. \leq 1\% (Z_{OUT} = 50\Omega)$ </p>	-	200	400	ns
	Turn-on Time	t _{on}		-	250	500	
	Fall Time	t _f		-	110	250	
	Turn-off Time	t _{off}		-	600	1000	
Source Drain Forward Voltage		V _{DSF}	I _D =-8A, V _{GS} =0	-	1.0	1.8	V
Reverse Recovery Time		t _{rr}	I _D =-8A, R _G =220Ω V _{GS} =-15V, di/dt=60A/µs	-	140	250	ns



SEMICONDUCTOR

TECHNICAL DATA

查询"MG8G4EM1"供应商

2SK568

MG8G4GM1

MG8G6EM1

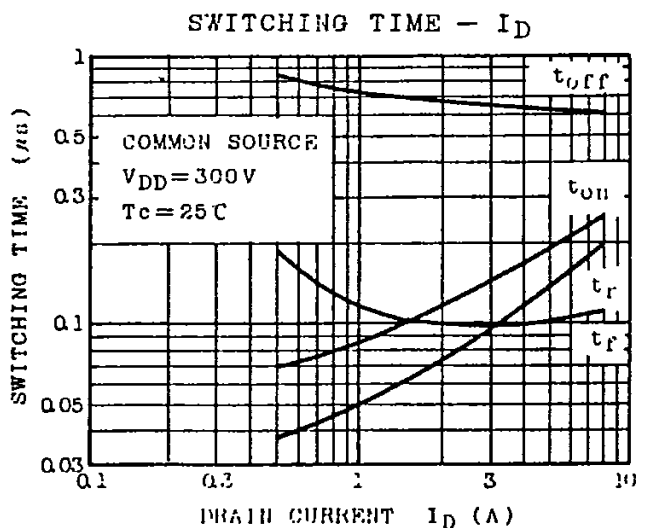
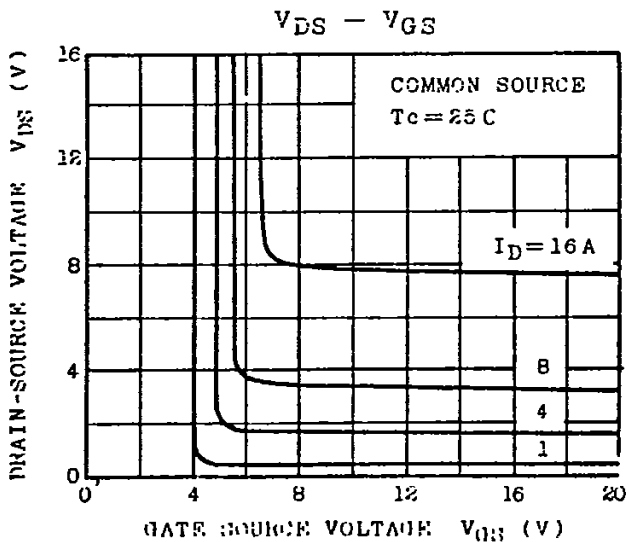
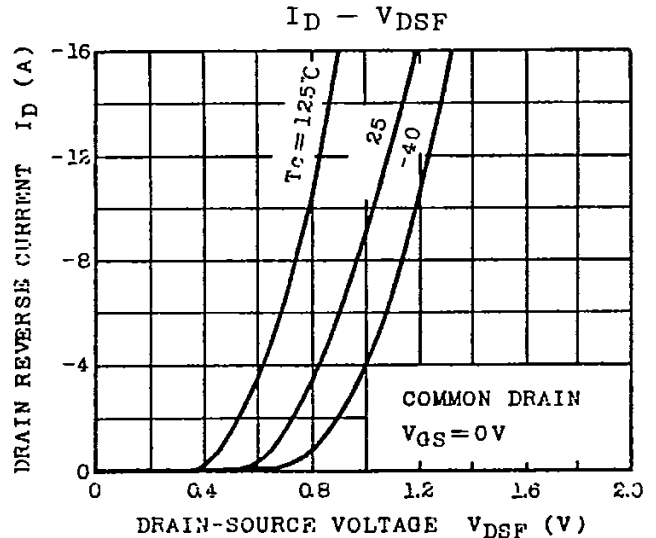
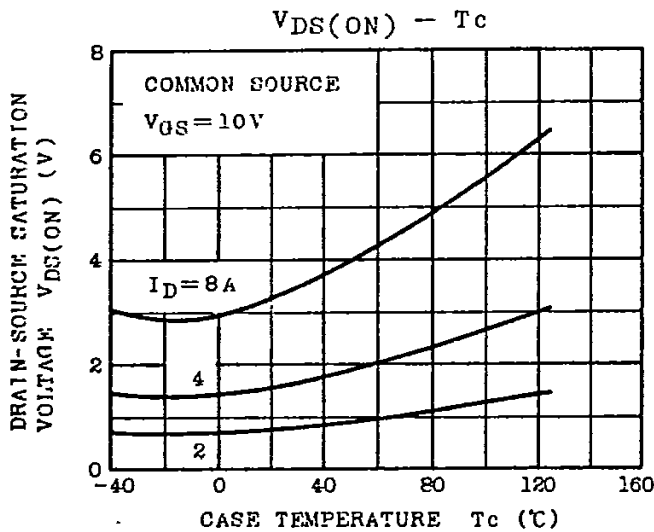
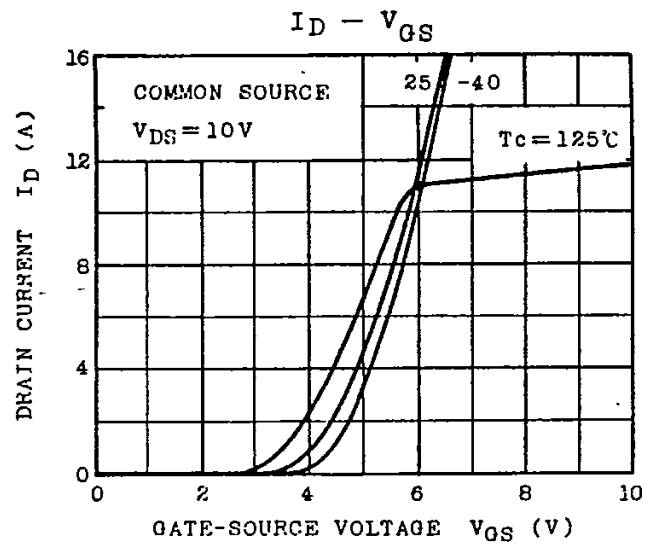
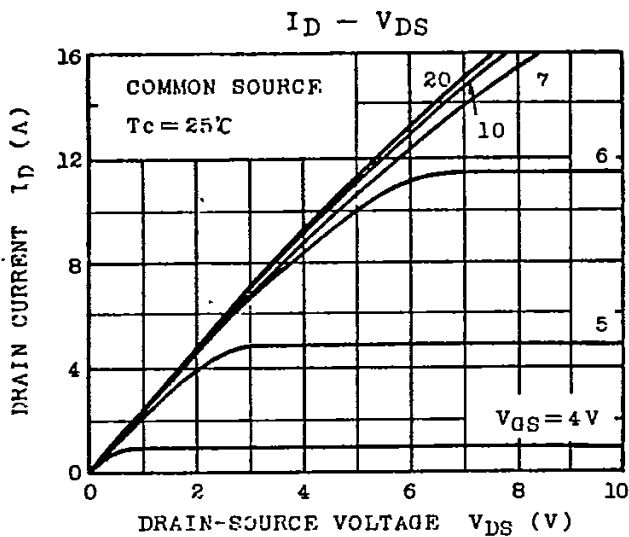

TOSHIBA CORPORATION

查询"MG8G4EM1"供应商

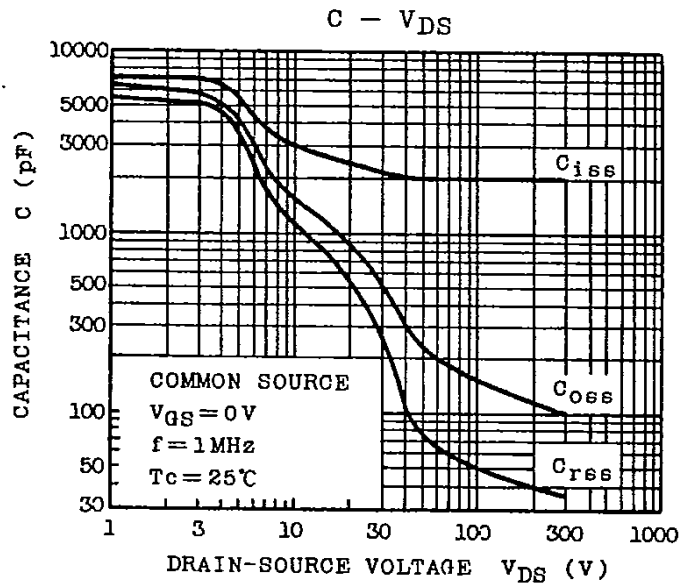
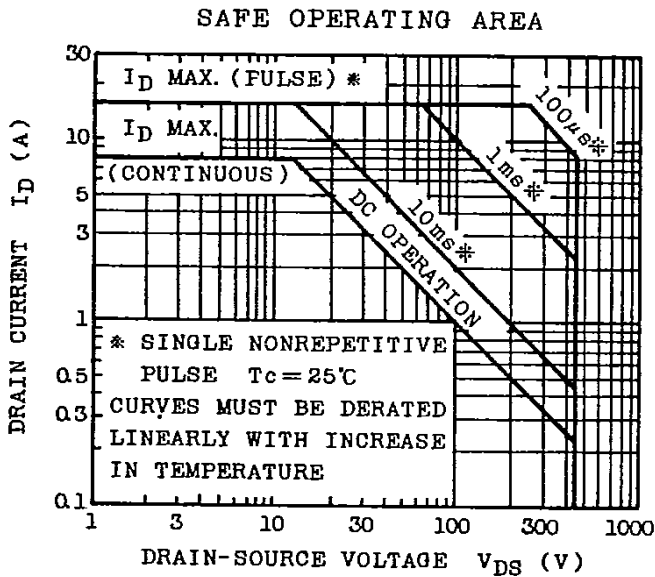
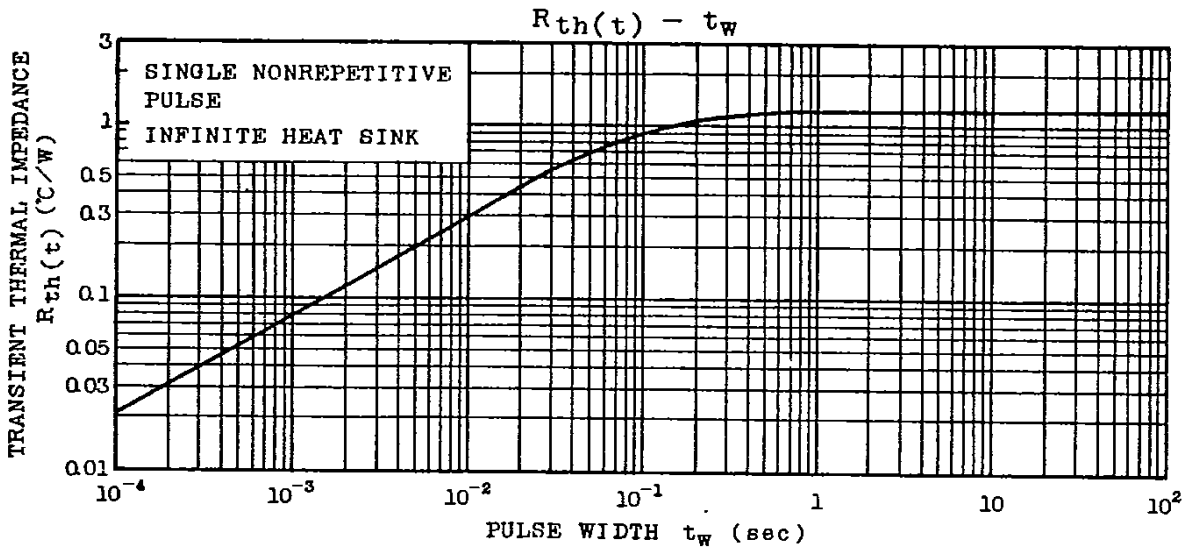

SWITCHING TIME TEST (WAVEFORM)

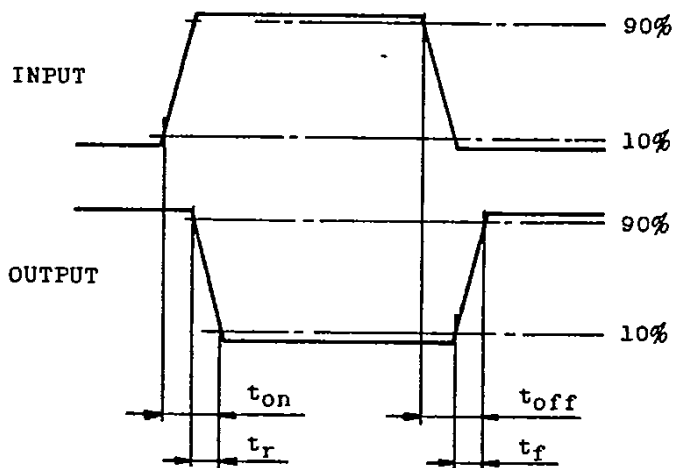

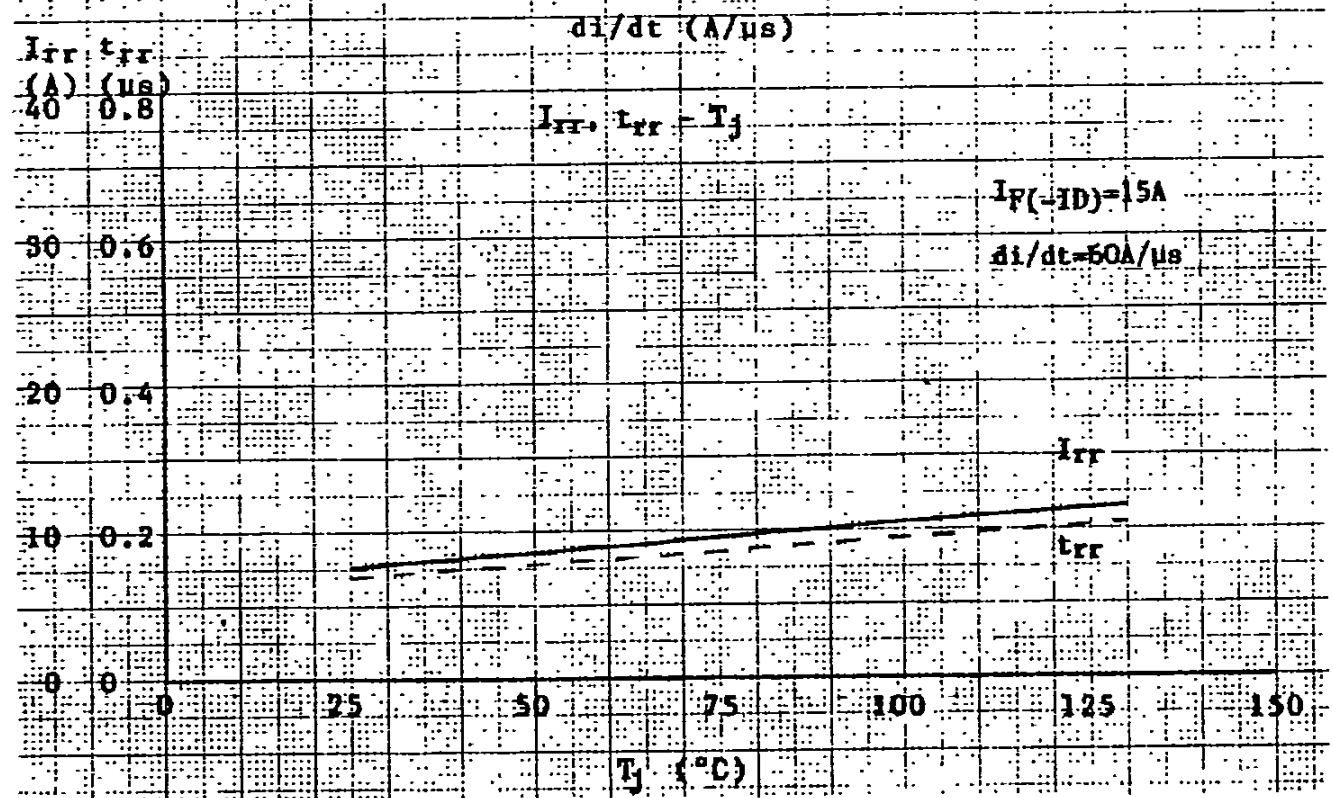
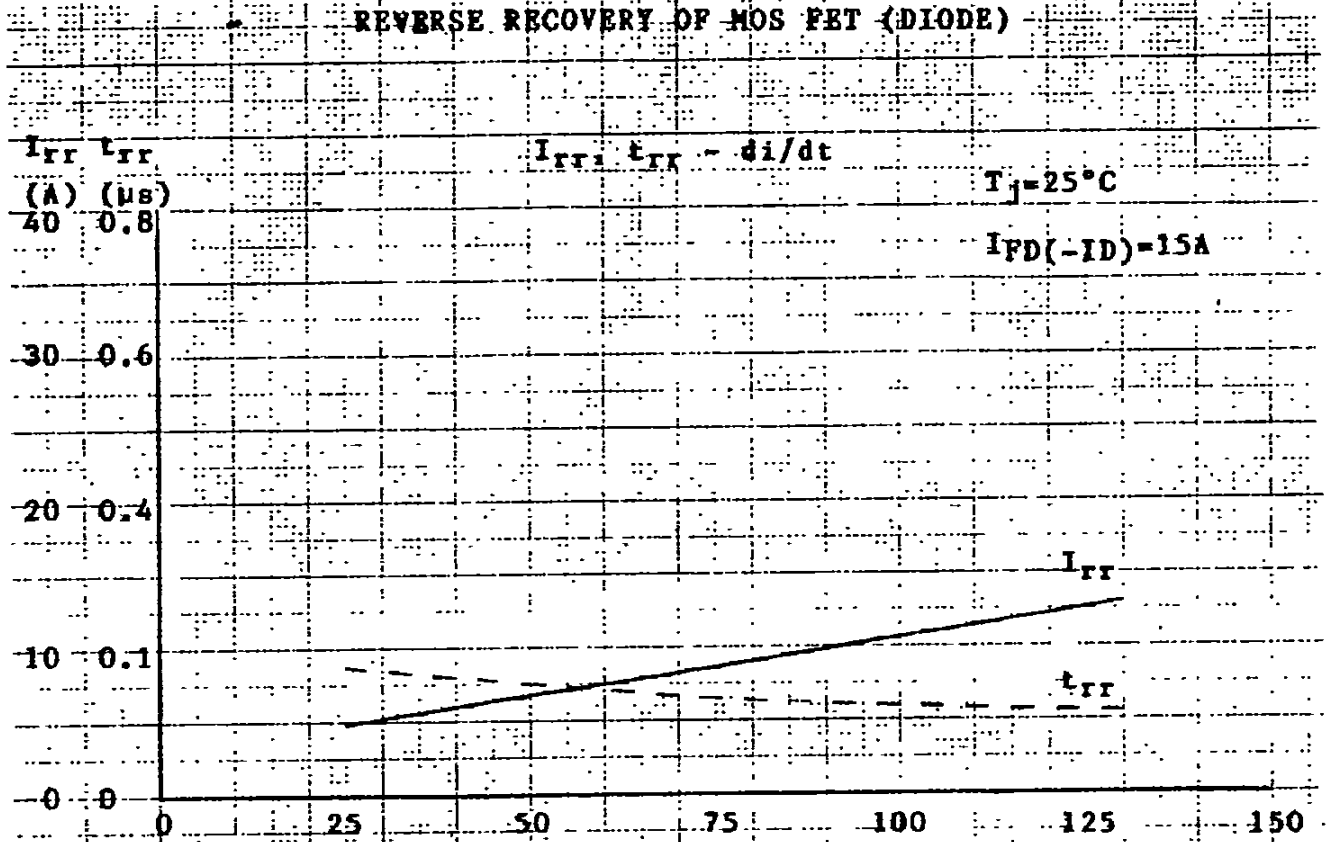

R_G — SWITCHING TIME

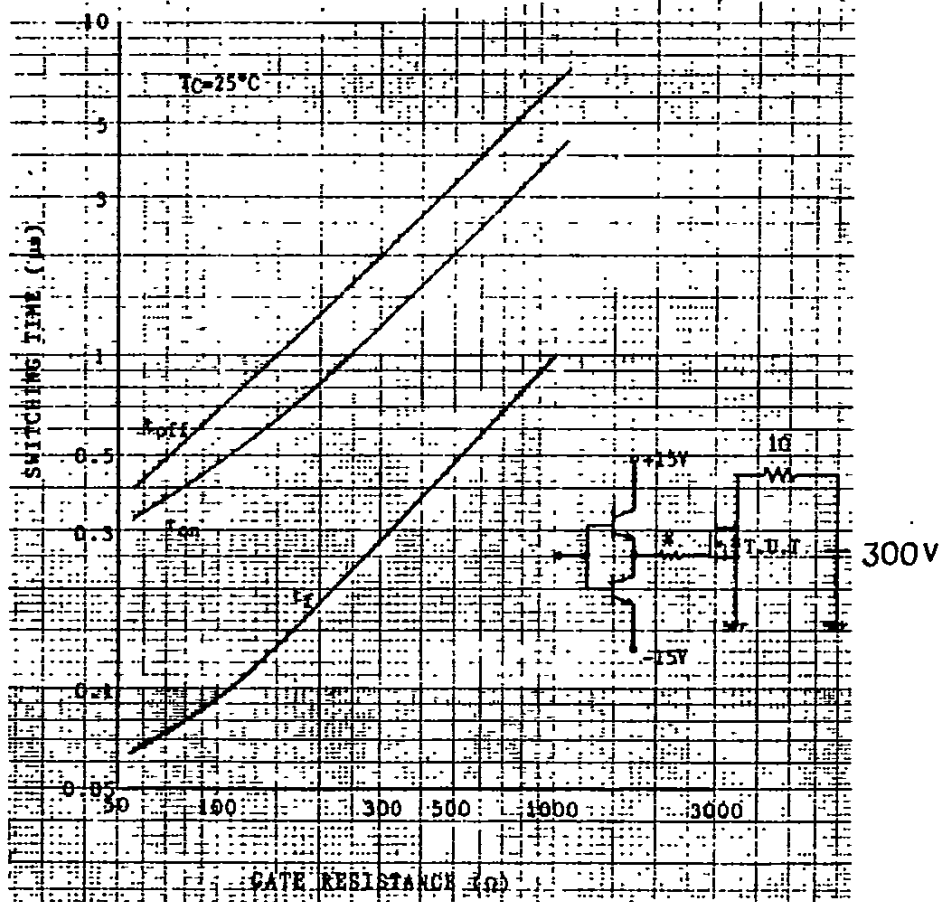

REVERSE BIAS — $\frac{dv}{dt}$ CURRENT

