

## Silicon N-Channel MOSFET

### Features

- 4.5A,500V, $R_{DS(on)}$ (Max 1.5 $\Omega$ )@ $V_{GS}=10V$
- Ultra-low Gate Charge(Typical 32nC)
- Fast Switching Capability
- 100%Avalanche Tested
- Maximum Junction Temperature Range(150°C)

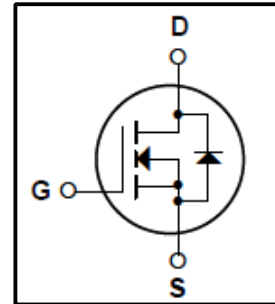

### General Description

This Power MOSFET is produced using Winsemi's advanced planar stripe, DMOS technology. This latest technology has been especially designed to minimize on-state resistance, have a high rugged avalanche characteristics. This devices is specially well suited for high efficiency switch model power supplies, power factor correction and half bridge and full bridge resonant topology line a electronic lamp ballast.

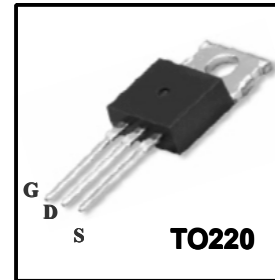

### Absolute Maximum Ratings

Symbol	Parameter	Value	Units
$V_{DSS}$	Drain Source Voltage	500	V
$I_D$	Continuous Drain Current(@Tc=25°C)	4.5	A
	Continuous Drain Current(@Tc=100°C)	2.9	A
$I_{DM}$	Drain Current Pulsed (Note 1)	18	A
$V_{GS}$	Gate to Source Voltage	$\pm 30$	V
$E_{AS}$	Single Pulsed Avalanche Energy (Note 2)	300	mJ
$E_{AR}$	Repetitive Avalanche Energy (Note 1)	7.5	mJ
dv/dt	Peak Diode Recovery dv/dt (Note 3)	4.5	V/ns
$P_D$	Total Power Dissipation(@Tc=25°C)	73	W
	Derating Factor above 25°C	0.55	W/°C
$T_J, T_{stg}$	Junction and Storage Temperature	-55~150	°C
$T_L$	Maximum lead Temperature for soldering purposes	300	°C

### Thermal Characteristics

Symbol	Parameter	Value			Units
		Min	Typ	Max	
$R_{QJC}$	Thermal Resistance, Junction-to-Case	-	-	1.7	°C/W
$R_{QCS}$	Thermal Resistance, Case to Sink	-	0.5	-	°C/W
$R_{QJA}$	Thermal Resistance, Junction-to-Ambient	-	-	62.5	°C/W

**Electrical Characteristics (Tc = 25°C)**

Characteristics	Symbol	Test Condition	Min	Type	Max	Unit	
Gate leakage current	$I_{GSS}$	$V_{GS} = \pm 30 V, V_{DS} = 0 V$	-	-	$\pm 100$	nA	
Gate-source breakdown voltage	$V_{(BR)GSS}$	$I_G = \pm 10 \mu A, V_{DS} = 0 V$	$\pm 30$	-	-	V	
Drain cut-off current	$I_{DSS}$	$V_{DS} = 500 V, V_{GS} = 0 V$	-	-	1	$\mu A$	
Drain-source breakdown voltage	$V_{(BR)DSS}$	$I_D = 250 \mu A, V_{GS} = 0 V$	500	-	-	V	
Break Voltage Temperature Coefficient	$\frac{\Delta BV_{DSS}}{\Delta T_J}$	$I_D = 250 \mu A$ , Referenced to 25°C	-	0.55	-	V/°C	
Gate threshold voltage	$V_{GS(th)}$	$V_{DS} = 10 V, I_D = 250 \mu A$	2	-	4	V	
Drain-source ON resistance	$R_{DS(ON)}$	$V_{GS} = 10 V, I_D = 2.25 A$	-	1.16	1.5	$\Omega$	
Forward Transconductance	gfs	$V_{DS} = 40 V, I_D = 2.25 A$	-	4.2		S	
Input capacitance	$C_{iss}$	$V_{DS} = 25 V,$	-	800	1050	pF	
Reverse transfer capacitance	$C_{rss}$	$V_{GS} = 0 V,$	-	18	23		
Output capacitance	$C_{oss}$	$f = 1 MHz$	-	76	100		
Switching time	Rise time	$t_r$	$V_{DD} = 250 V,$	-	15	40	ns
	Turn-on time	$t_{on}$	$I_D = 4.5 A$	-	40	90	
	Fall time	$t_f$	$R_G = 25 \Omega$	-	85	180	
	Turn-off time	$t_{off}$	(Note4,5)	-	45	100	
Total gate charge (gate-source plus gate-drain)	$Q_g$	$V_{DD} = 400 V,$ $V_{GS} = 10 V,$	-	32	44	nC	
Gate-source charge	$Q_{gs}$	$I_D = 4.5 A$	-	3.7	-		
Gate-drain ("miller") Charge	$Q_{gd}$	(Note4,5)	-	15	-		

**Source-Drain Ratings and Characteristics (Ta = 25°C)**

Characteristics	Symbol	Test Condition	Min	Type	Max	Unit
Continuous drain reverse current	$I_{DR}$	-	-	-	4.5	A
Pulse drain reverse current	$I_{DRP}$	-	-	-	18	A
Forward voltage (diode)	$V_{DSF}$	$I_{DR} = 4.5 A, V_{GS} = 0 V$	-	-	1.4	V
Reverse recovery time	$t_{rr}$	$I_{DR} = 4.5 A, V_{GS} = 0 V,$	-	305	-	ns
Reverse recovery charge	$Q_{rr}$	$di_{DR} / dt = 100 A / \mu s$	-	2.6	-	$\mu C$

Note 1.Repeativity rating :pulse width limited by junction temperature

2.L=24mH, $I_{AS}=4.5A, V_{DD}=50V, R_G=25\Omega$ ,Starting  $T_J=25^\circ C$

3. $I_{SD} \leq 4.5A, di/dt \leq 300A/\mu s, V_{DD} < BV_{DSS}$ ,STARTING  $T_J=25^\circ C$

4.Pulse Test: Pulse Width $\leq 300\mu s$ ,Duty Cycle $\leq 2\%$

5.Essentially independent of operating temperature.

This transistor is an electrostatic sensitive device

Please handle with caution

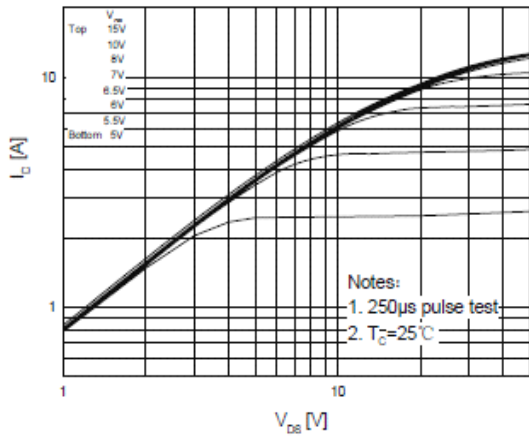

**Fig. 1 On-State Characteristics**

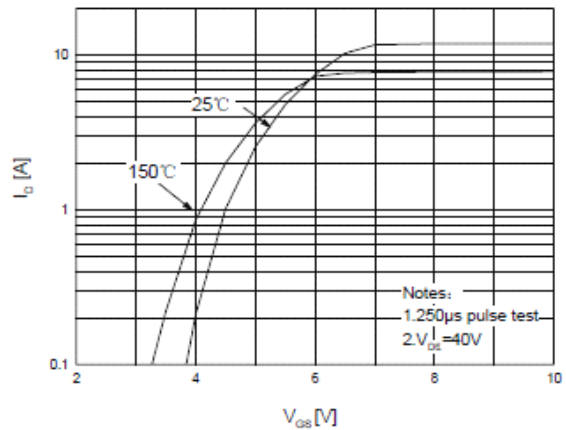

**Fig. 2 Transfer Characteristics**

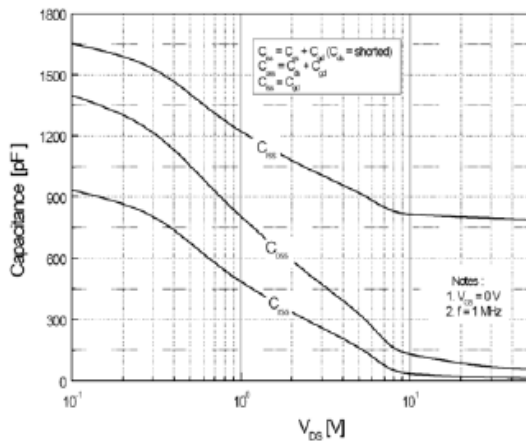

**Fig. 3 Capacitance Variation vs Drain Voltage**

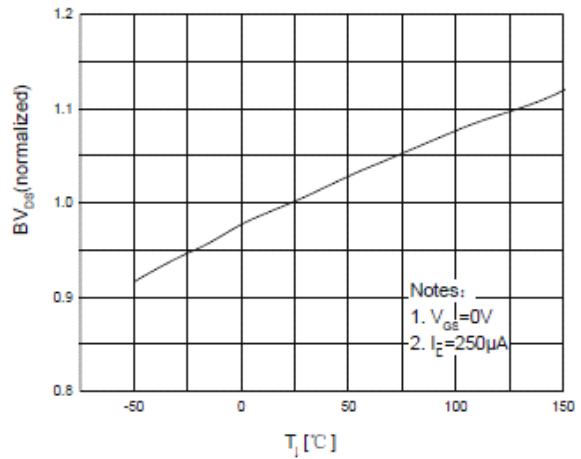

**Fig. 4 Breakdown Voltage Variation vs Temperature**

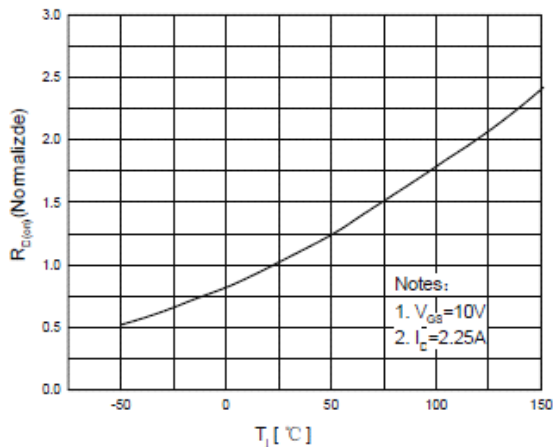

**Fig. 5 On-Resistance Variation vs Junction Temperature**

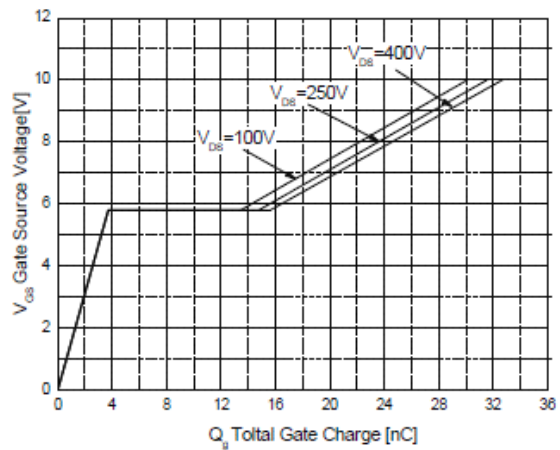

**Fig. 6 Gate Charge Characteristics**

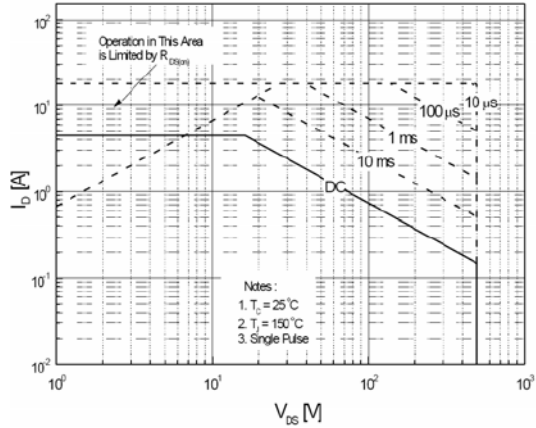

**Fig.7 Maximum Safe Operation Area**

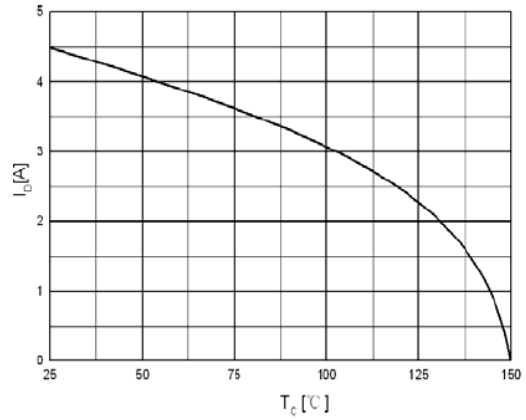

**Fig.8 Maximum Drain Current vs Case Temperature**

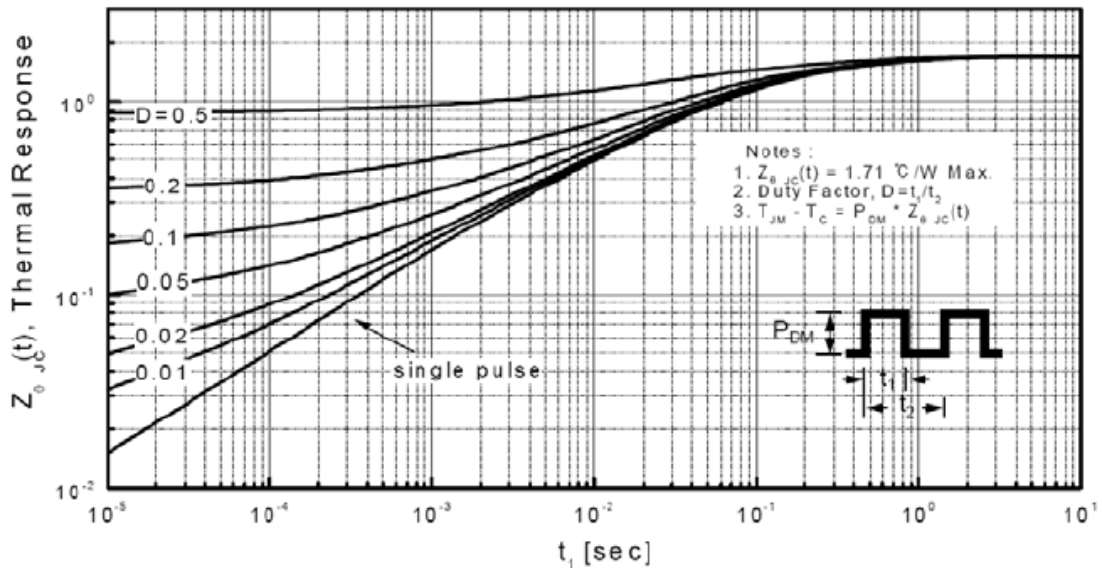

**Fig.9 Transient Thermal Response Curve**

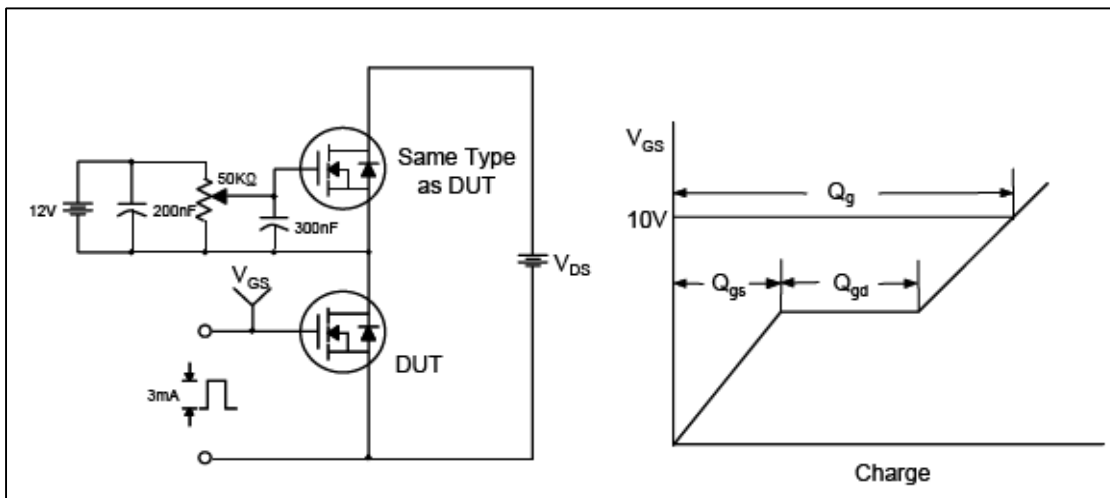

**Fig.10 Gate Test Circuit & Waveform**

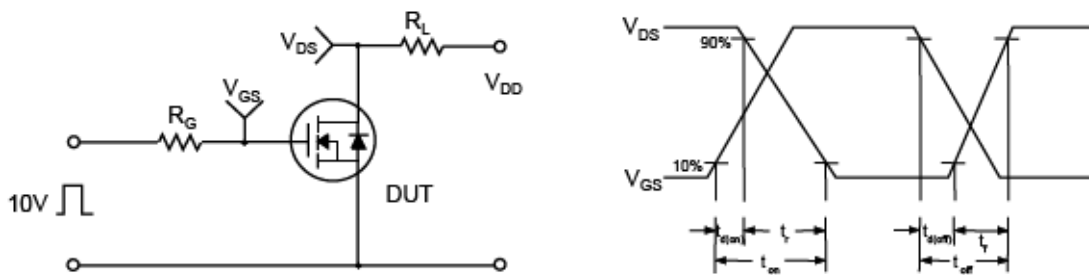

**Fig.11 Resistive Switching Test Circuit & Waveform**

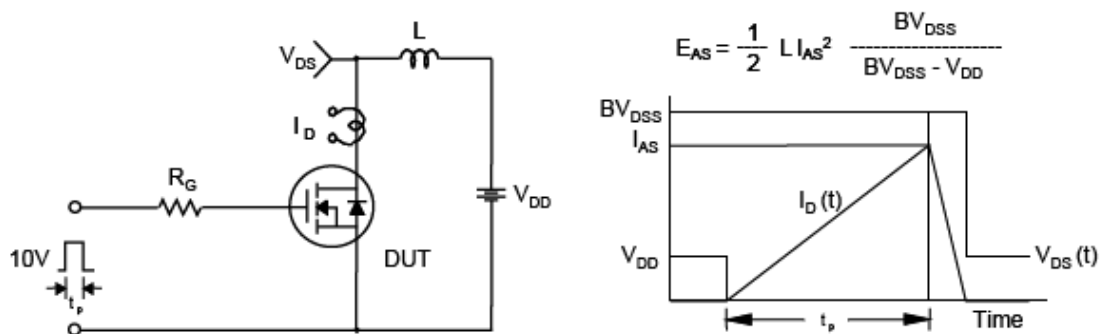

**Fig.12 Unclamped Inductive Switching Test Circuit & Waveform**

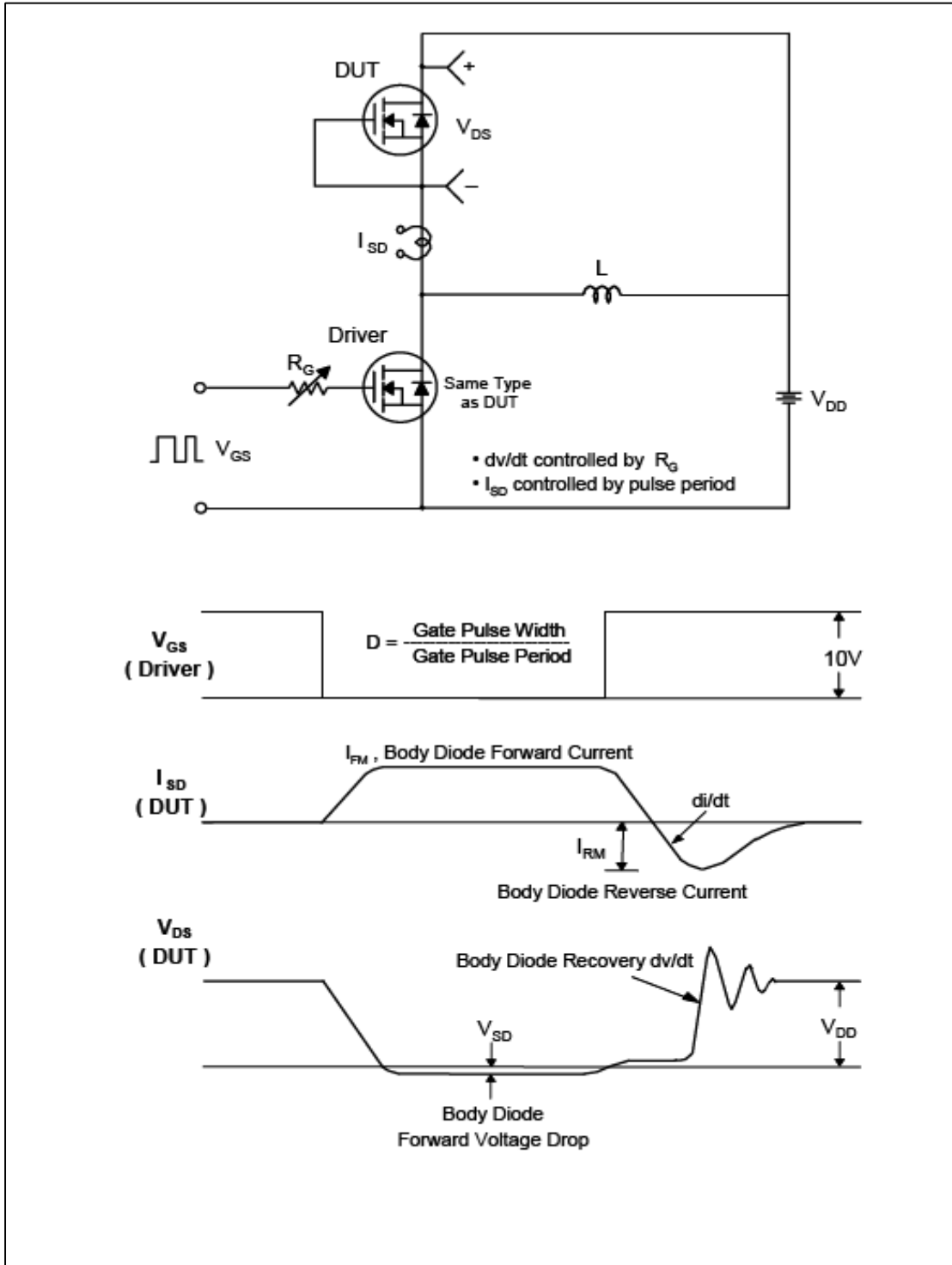

**Fig.13 Peak Diode Recovery  $dv/dt$  Test Circuit & Waveform**

**TO-220C Package Dimension**

