

Silicon N-Channel MOSFET

Features

- 4.5A,600V, $R_{DS(on)}$ (Max2.5 Ω)@ $V_{GS}=10V$
- Ultra-low Gate charge(Typical 15nC)
- Fast Switching Capability
- 100%Avalanche Tested
- Maximum Junction Temperature Range(150 $^{\circ}C$)

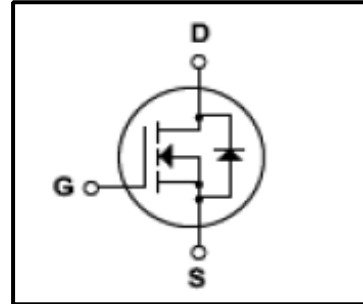

General Description

This Power MOSFET is produced using Winsemi's advanced planar stripe,VDMOS technology.this latest technology has been especially designed to minimize on-state resistance, have a high rugged avalanche characteristics .This devices is specially well suited for half bridge and full bridge resonant topology line a electronic lamp ballast, high efficiency switched mode power supplies, active power factor correction.

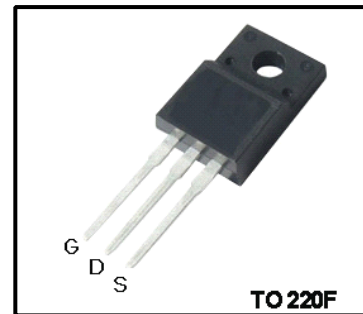

Absolute Maximum Ratings

Symbol	Parameter	Value	Units
V_{DSS}	Drain Source Voltage	600	V
I_D	Continuous Drain Current(@ $T_c=25^{\circ}C$)	4.5*	A
	Continuous Drain Current(@ $T_c=100^{\circ}C$)	3.1*	A
I_{DM}	Drain Current Pulsed (Note1)	16*	A
V_{GS}	Gate to Source Voltage	± 30	V
E_{AS}	Single Pulsed Avalanche Energy (Note2)	240	mJ
E_{AR}	Repetitive Avalanche Energy (Note1)	10	mJ
dv/dt	Peak Diode Recovery dv /dt (Note3)	4.5	V/ns
P_D	Total Power Dissipation(@ $T_c=25^{\circ}C$)	27	W
	Derating Factor above 25 $^{\circ}C$	0.21	W/ $^{\circ}C$
T_J, T_{stg}	Junction and Storage Temperature	-55~150	$^{\circ}C$
T_L	Channel Temperature	300	$^{\circ}C$

*Drain current limited by junction temperature

Thermal Characteristics

Symbol	Parameter	Value			Units
		Min	Typ	Max	
R_{QJC}	Thermal Resistance , Junction -to -Case	-	-	4.63	$^{\circ}C/W$
R_{QJA}	Thermal Resistance , Junction-to -Ambient	-	-	62.5	$^{\circ}C/W$

Electrical Characteristics(Tc=25°C)

Characteristics	Symbol	Test Condition	Min	Type	Max	Unit	
Gate leakage current	I _{GSS}	V _{GS} =±30V,V _{DS} =0V	-	-	±100	nA	
Gate-source breakdown voltage	V _{(BR)GSS}	I _G =±10 μA,V _{DS} =0V	±30	-	-	V	
Drain Cut -off current	I _{DSS}	V _{DS} =600V,V _{GS} =0V	-	-	10	μA	
		V _{DS} =480V,Tc=125°C	-	-	100	μA	
Breakdown voltage Temperature coefficient	$\Delta BV_{DSS}/\Delta T_J$	I _D =250 μA,Referenced to 25°C	-	0.6	-	V/°C	
Drain -source breakdown voltage	V _{(BR)DSS}	I _D =250 μA,V _{GS} =0V	600	-	-	V	
Gate threshold voltage	V _{GS(th)}	V _{DS} =V _{GS} ,I _D =250 μA	2	-	4	V	
Drain -source ON resistance	R _{DS(ON)}	V _{GS} =10V,I _D =2.2A	-	2.0	2.5	Ω	
Forward Transconductance	g _{fs}	V _{DS} =50V,I _D =2.2A	-	4.0	-	S	
Input capacitance	C _{iss}	V _{DS} =25V,	-	440	611	pF	
Reverse transfer capacitance	C _{rss}	V _{GS} =0V,	-	7	9		
Output capacitance	C _{oss}	f=1MHz	-	62	80		
Switching time	Turn-on Rise time	tr	V _{DD} =300V, I _D =4.4A R _G =25Ω (Note4,5)	-	37	98	ns
	Turn-on delay time	ton		-	13	35	
	Turn-off Fall time	tf		-	29	73	
	Turn-off delay time	toff		-	38	89	
Total gate charge(gate-source plus gate-drain)	Q _g	V _{DD} =480V, V _{GS} =10V,	-	15	20	nC	
Gate-source charge	Q _{gs}	I _D =4.4A	-	3.4	-		
Gate-drain("miller") Charge	Q _{gd}	(Note,5)	-	7.1	-		

Source-Drain Ratings and Characteristics(Ta=25°C)

Characteristics	Symbol	Test Condition	Min	Type	Max	Unit
Continuous drain reverse current	I _{DR}	-	-	-	4.5	A
Pulse drain reverse current	I _{DRP}	-	-	-	17.6	A
Forward voltage(diode)	V _{DSF}	I _{DR} =4.4A,V _{GS} =0V	-	-	1.4	V
Reverse recovery time	trr	I _{DR} =4.4A,V _{GS} =0V,	250	-	-	ns
Reverse recovery charge	Q _{rr}	dI _{DR} /dt =100 A /μs	1.5	-	-	μC

Note 1.Repeativity rating :pulse width limited by junction temperature

2.L=25mH I_{AS}=4.4A,V_{DD}=50V,R_G=25Ω,Starting T_J=25°C

3.I_{SD}≤4.5A,di/dt≤200A/μs,V_{DD}<BV_{DSS},STARTING T_J=25°C

4.Pulse Test:Pulse Width≤300us,Duty Cycle≤2%

5. Essentially independent of operating temperature.

This transistor is an electrostatic sensitive device

Please handle with caution



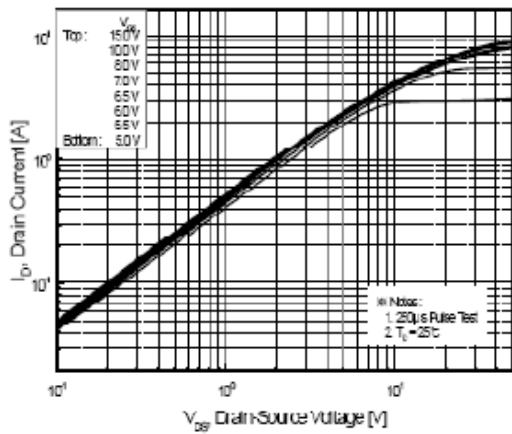

Fig.1 On-State characteristics

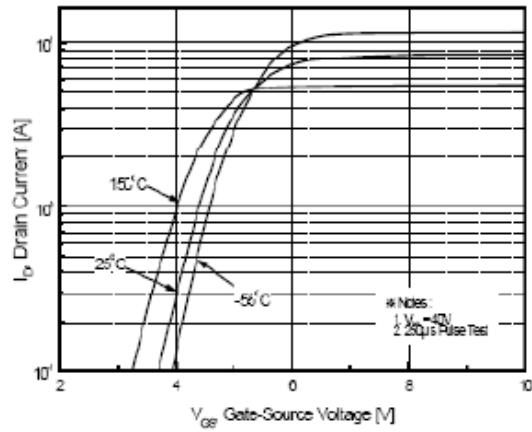

Fig.2 Transfer Current characteristics

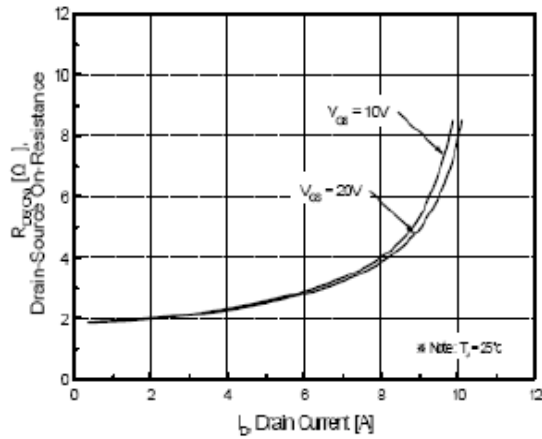

Fig.3 On-Resistance Variation vs Drain Current

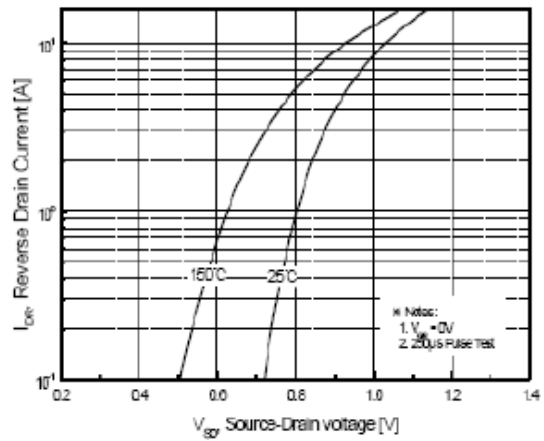

Fig.4 Body Diode Forward Voltage Variation with Source Current and Temperature

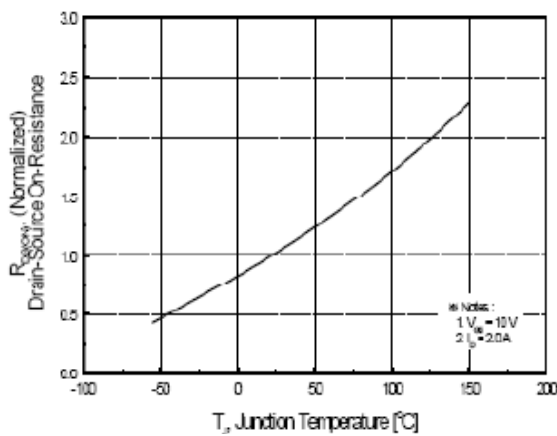

Fig.5 On-Resistance Variation vs Junction Temperature

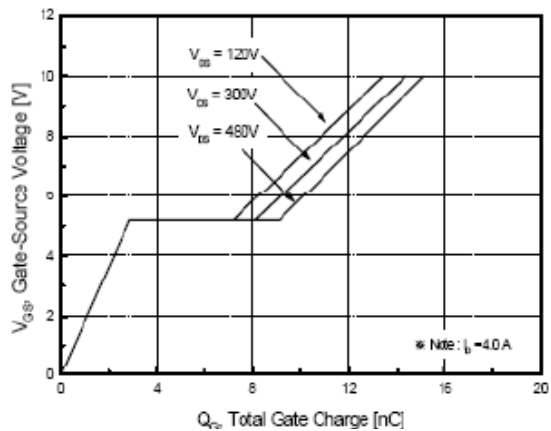

Fig.6 Gate Charge Characteristics

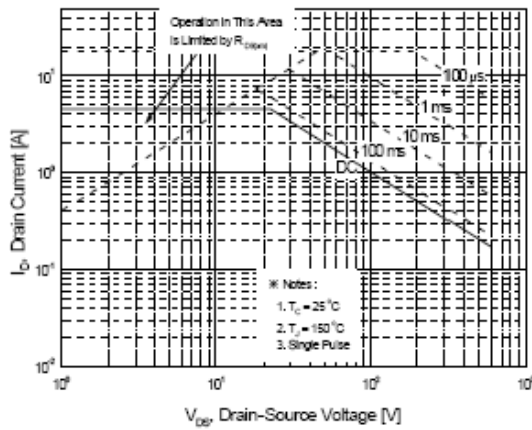

Fig.7 Maximum Safe Operation Area

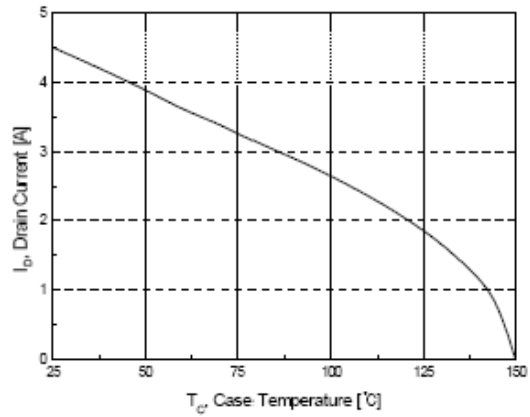

Fig.8 Maximum Drain Current vs Case Temperature

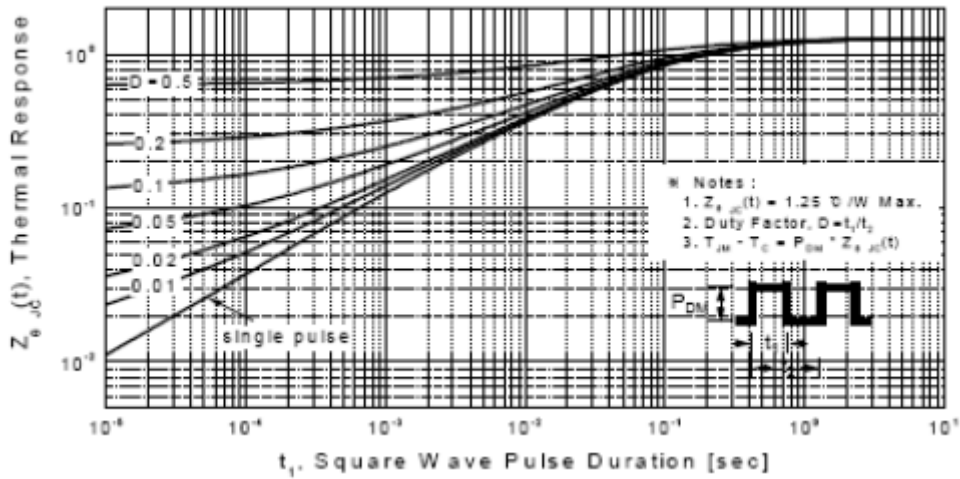

Fig.9 Transient Thermal Response Curve

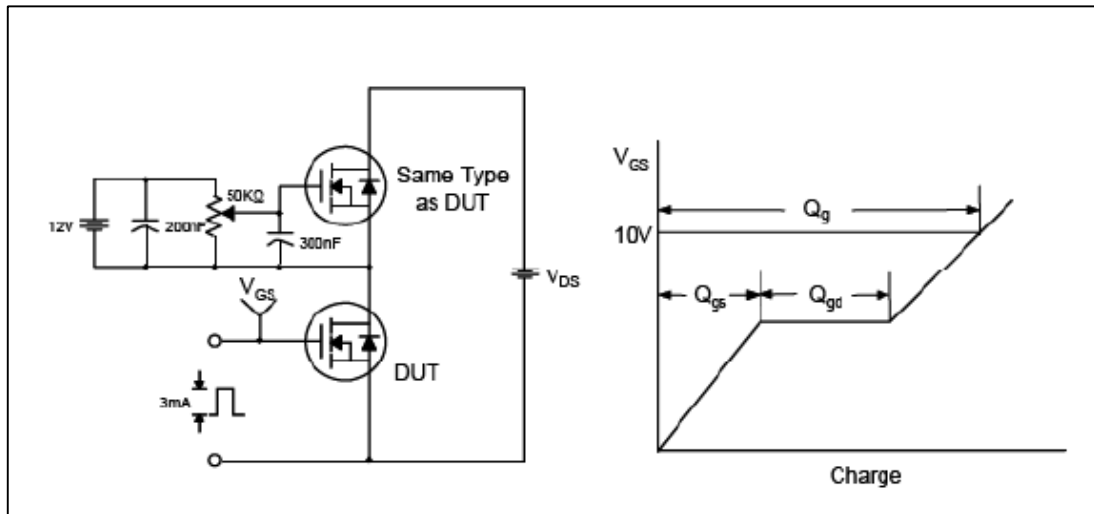

Fig.10 Gate Test Circuit & Waveform

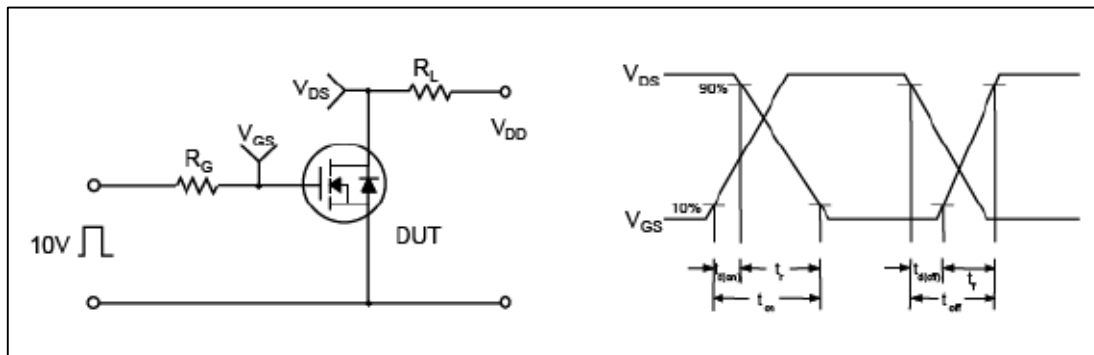

Fig.11 Resistive Switching Test Circuit & Waveform

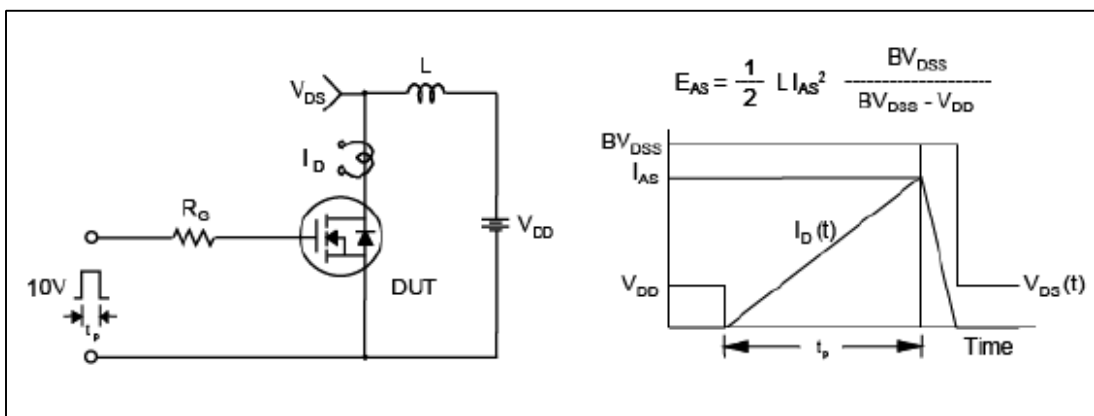

Fig.12 Unclamped Inductive Switching Test Circuit & Waveform

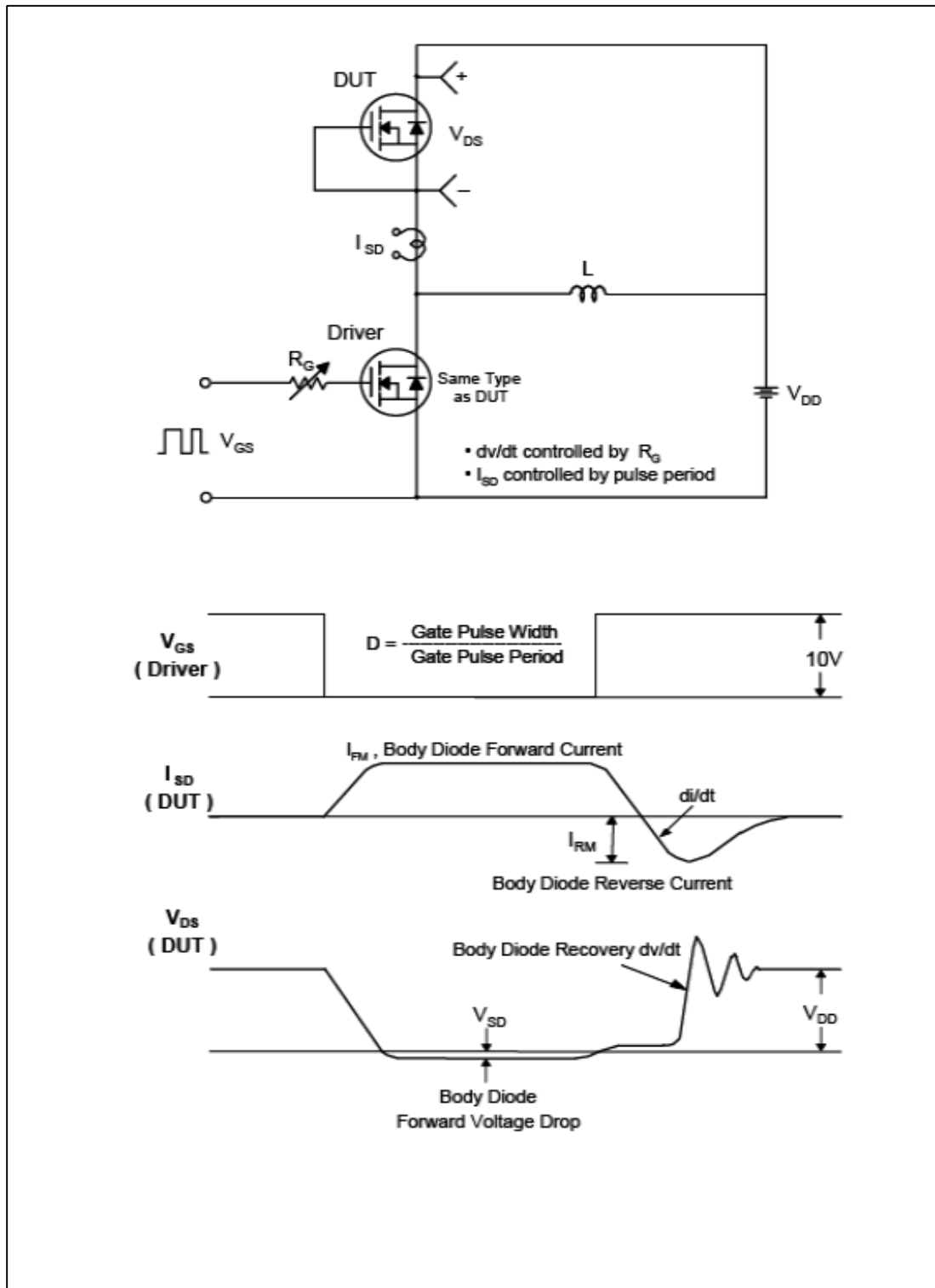

Fig.13 Peak Diode Recovery dv/dt Test Circuit & Waveform

TO-220F Package Dimension

