

Features

- 4.5A,600V, $R_{DS(on)}$ (Max 2.2 Ω)@ $V_{GS}=10V$
- Ultra-low Gate Charge(Typical 16nC)
- Fast Switching Capability
- 100%Avalanche Tested
- Maximum Junction Temperature Range(150°C)

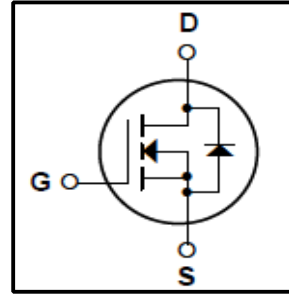

General Description

This Power MOSFET is produced using Winsemi's advanced Planar stripe, VDMOS technology. This latest technology has been especially designed to minimize on-state resistance, have a high rugged avalanche characteristics. This devices is specially well suited for half bridge and full bridge resonant topology line a electronic lamp ballast.

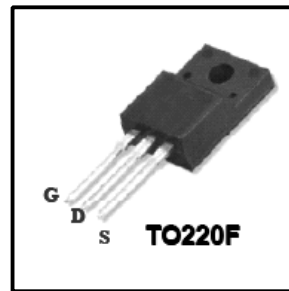

Absolute Maximum Ratings

Symbol	Parameter	Value	Units
V_{DSS}	Drain Source Voltage	600	V
I_D	Continuous Drain Current(@ $T_c=25^\circ C$)	4.5*	A
	Continuous Drain Current(@ $T_c=100^\circ C$)	3.1*	A
I_{DM}	Drain Current Pulsed (Note1)	16*	A
V_{GS}	Gate to Source Voltage	± 30	V
E_{AS}	Single Pulsed Avalanche Energy (Note 2)	240	mJ
E_{AR}	Repetitive Avalanche Energy (Note 1)	10	mJ
dv/dt	Peak Diode Recovery dv/dt (Note 3)	4.5	V/ns
P_D	Total Power Dissipation(@ $T_c=25^\circ C$)	33	W
	Derating Factor above 25°C	0.26	W/°C
T_J, T_{stg}	Junction and Storage Temperature	-55~150	°C
T_L	Channel Temperature	300	°C

*Drain current limited by junction temperature

Thermal Characteristics

Symbol	Parameter	Value			Units
		Min	Typ	Max	
$R_{\theta JC}$	Thermal Resistance, Junction-to-Case	-	-	3.79	°C/W
$R_{\theta JA}$	Thermal Resistance, Junction-to-Ambient	-	-	62.5	°C/W

Electrical Characteristics (Tc = 25°C)

Characteristics	Symbol	Test Condition	Min	Type	Max	Unit	
Gate leakage current	I _{GSS}	V _{GS} = ±30 V, V _{DS} = 0 V	-	-	±100	nA	
Gate-source breakdown voltage	V _{(BR)GSS}	I _G = ±10 μA, V _{DS} = 0 V	±30	-	-	V	
Drain cut-off current	I _{DSS}	V _{DS} = 600 V, V _{GS} = 0 V	-	-	10	μA	
		V _{DS} = 480 V, T _c = 125°C	-	-	100	μA	
Drain-source breakdown voltage	V _{(BR)DSS}	I _D = 250 μA, V _{GS} = 0 V	600	-	-	V	
Gate threshold voltage	V _{GS(th)}	V _{DS} = 10 V, I _D = 250 μA	2	-	4	V	
Drain-source ON resistance	R _{DS(ON)}	V _{GS} = 10 V, I _D = 2.2A	-	1.8	2.5	Ω	
Input capacitance	C _{iss}	V _{DS} = 25 V,	-	545	670	pF	
Reverse transfer capacitance	C _{rss}	V _{GS} = 0 V,	-	9	10.5		
Output capacitance	C _{oss}	f = 1 MHz	-	70	90		
Switching time	Rise time	t _r	V _{DD} = 300 V, I _D = 4.4 A R _G = 25 Ω (Note4,5)	-	10	30	ns
	Turn-on time	t _{on}		-	35	80	
	Fall time	t _f		-	45	100	
	Turn-off time	t _{off}		-	20	50	
Total gate charge (gate-source plus gate-drain)	Q _g	V _{DD} = 480 V, V _{GS} = 10 V, I _D = 4.4 A	-	16	20	nC	
Gate-source charge	Q _{gs}	(Note4,5)	-	3.4	-		
Gate-drain ("miller") Charge	Q _{gd}	(Note4,5)	-	7	-		

Source-Drain Ratings and Characteristics (Ta = 25°C)

Characteristics	Symbol	Test Condition	Min	Type	Max	Unit
Continuous drain reverse current	I _{DR}	-	-	-	4.5	A
Pulse drain reverse current	I _{DRP}	-	-	-	17.6	A
Forward voltage (diode)	V _{DSF}	I _{DR} = 4.4 A, V _{GS} = 0 V	-	-	1.4	V
Reverse recovery time	T _{rr}	I _{DR} = 4.4 A, V _{GS} = 0 V,	-	390	-	ns
Reverse recovery charge	Q _{rr}	dI _{DR} / dt = 100 A / μs	-	2.2	-	μC

Note 1.Repeativity rating :pulse width limited by junction temperature

2.L=18.5mH,I_{AS}=4.4A,V_{DD}=50V,R_G=0Ω,Starting T_J=25°C

3.I_{SD}≤4.5A,di/dt≤200A/μs, V_{DD}<BV_{DSS},STARTING T_J=25°C

4.Pulse Test: Pulse Width≤300μs,Duty Cycle≤2%

5.Essentially independent of operating temperature.

This transistor is an electrostatic sensitive device

Please handle with caution

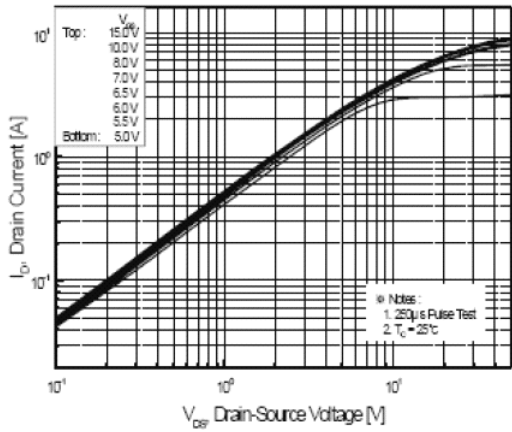

Fig. 1 On-State Characteristics

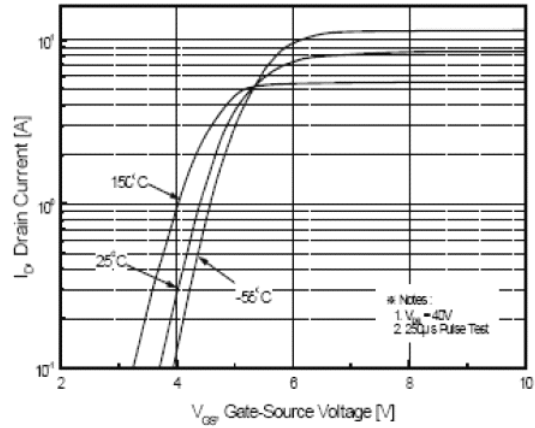

Fig. 2 Transfer Current Characteristics

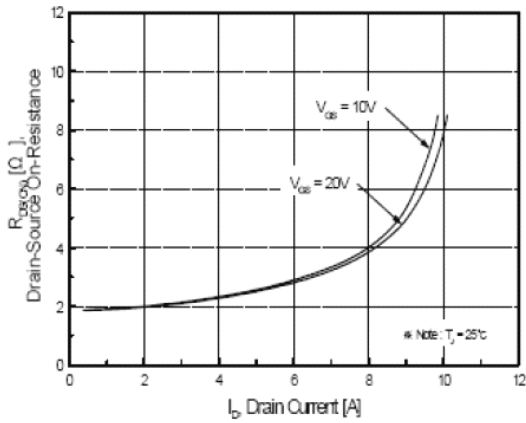

Fig. 3 On-Resistance Variation vs Drain Current

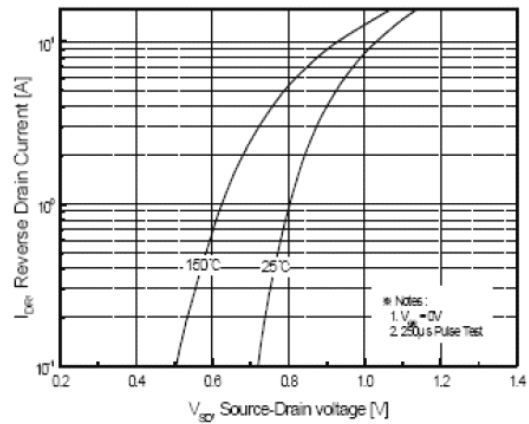

Figure 4. Body Diode Forward Voltage Variation with Source Current and Temperature

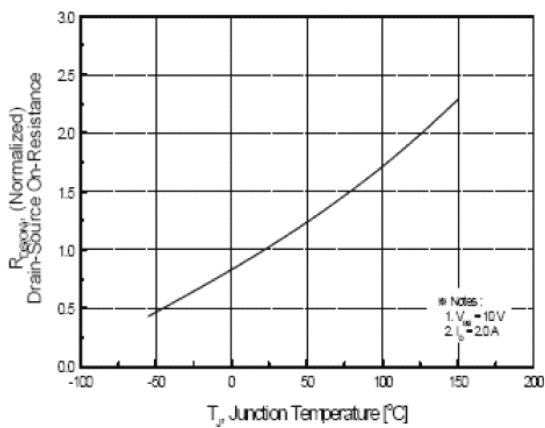

Fig. 5 On-Resistance Variation vs Junction Temperature

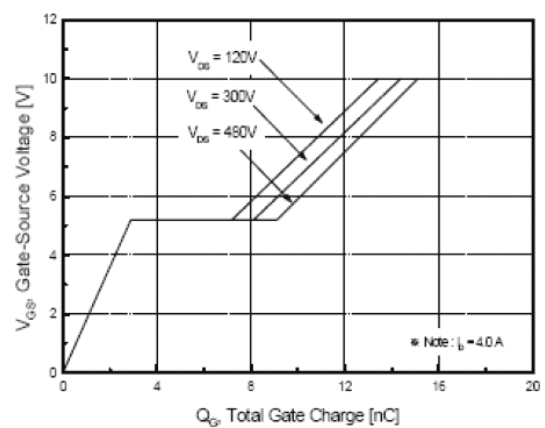

Fig. 6 Gate Charge Characteristics

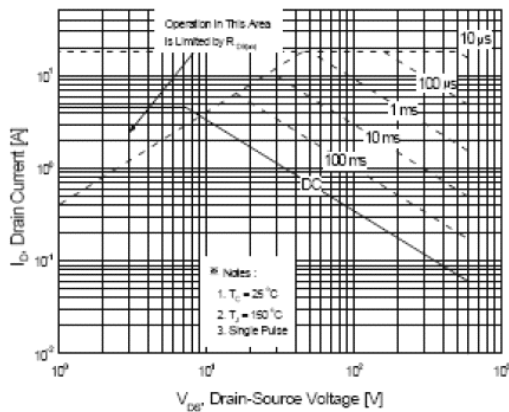

Fig.7 Maximum Safe Operation Area

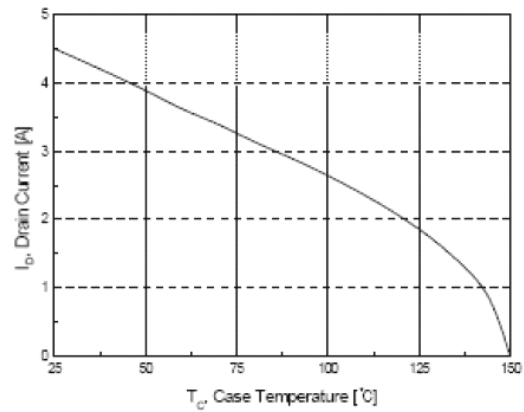

Fig.8 Maximum Drain Current vs Case Temperature

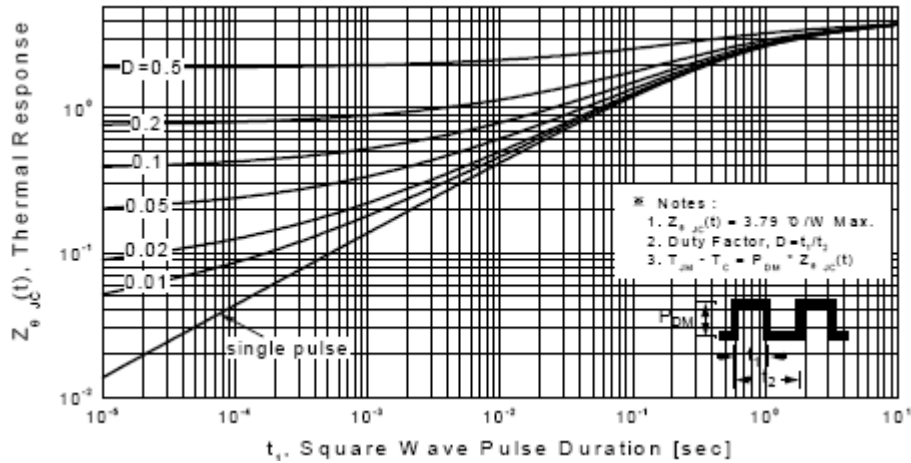

Fig.9 Transient Thermal Response Curve

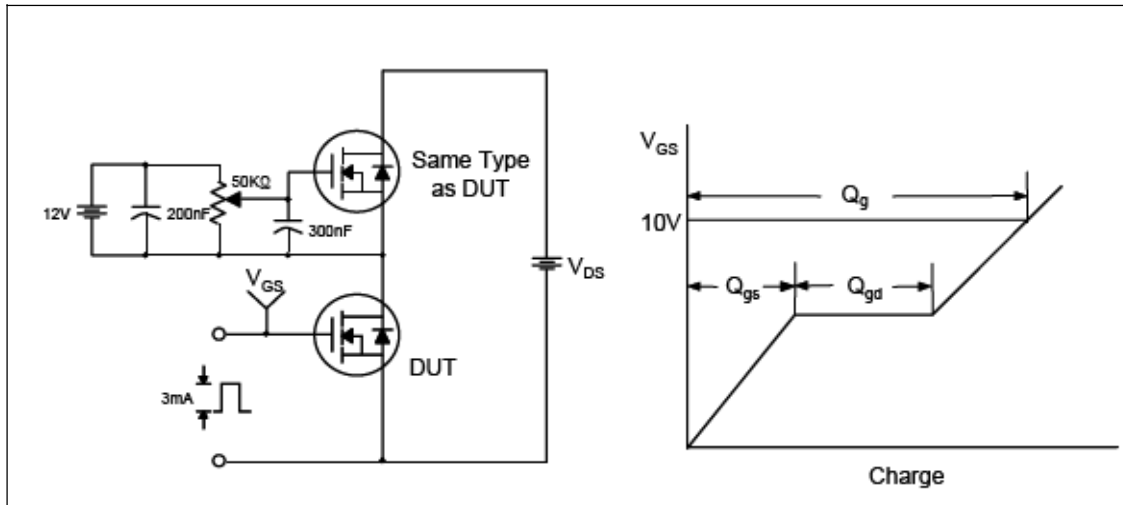

Fig.10 Gate Test Circuit & Waveform

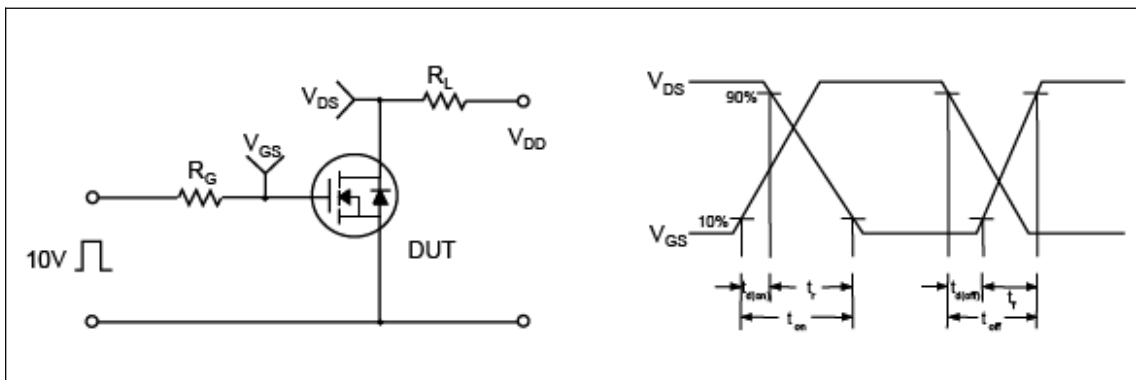

Fig.11 Resistive Switching Test Circuit & Waveform

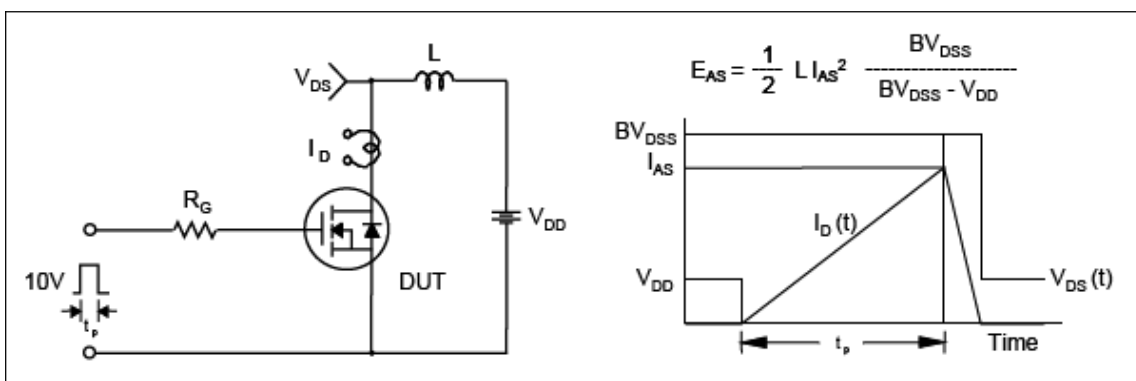

Fig.12 Unclamped Inductive Switching Test Circuit & Waveform

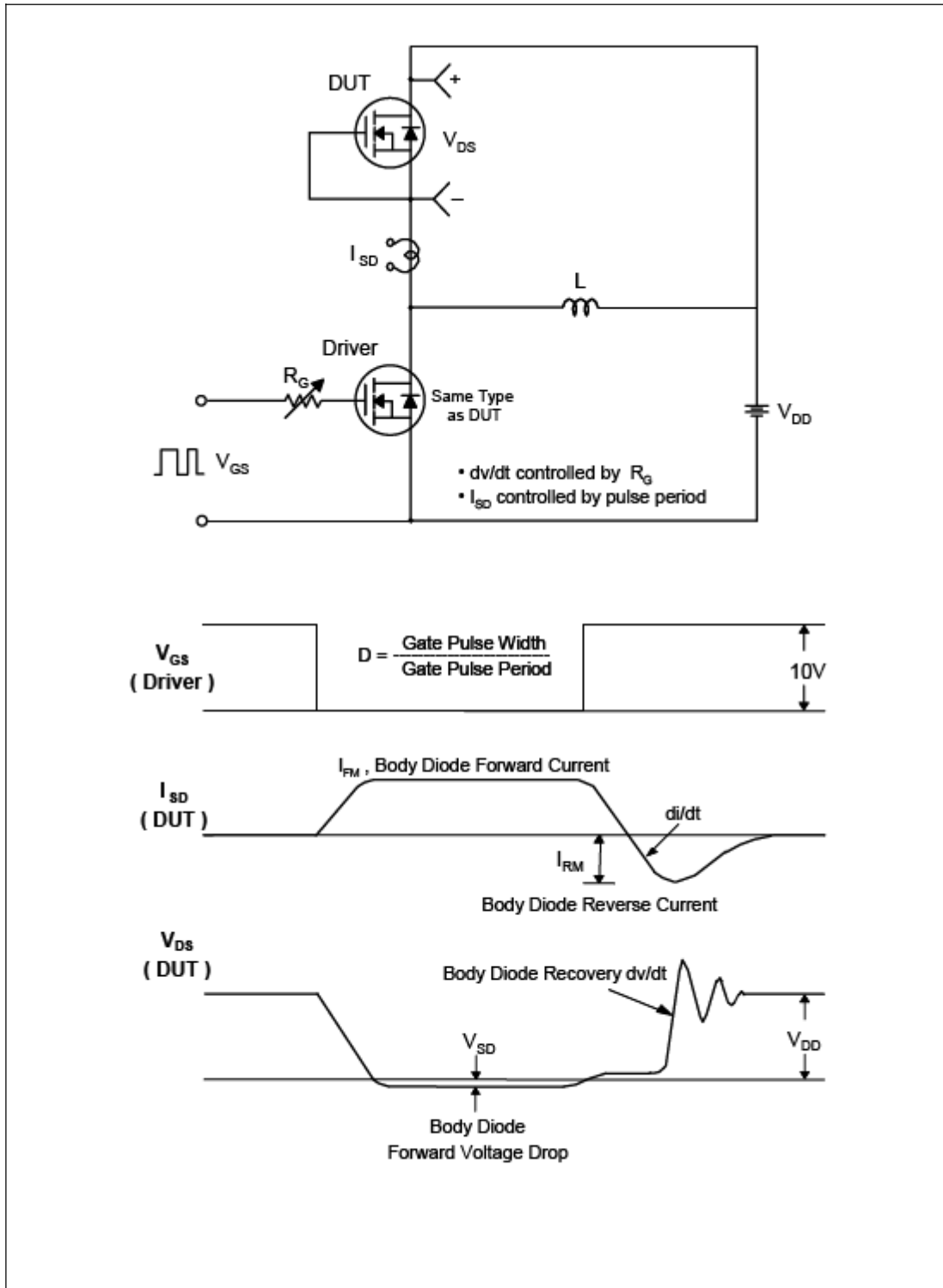

Fig.13 Peak Diode Recovery dv/dt Test Circuit & Waveform

TO-220F Package Dimension

