

Silicon N-Channel MOSFET

Features

- 2A,600V, $R_{DS(on)}$ (Max 5.0 Ω)@ $V_{GS}=10V$
- Ultra-low Gate Charge(Typical 15.3nC)
- Fast Switching Capability
- 100%Avalanche Tested
- Maximum Junction Temperature Range(150 °C)

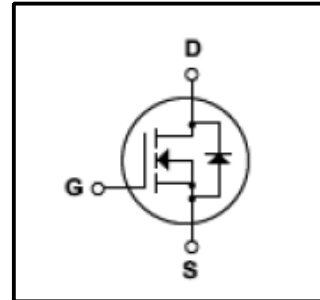

General Description

This Power MOSFET is produced using Winsemi's advanced planar stripe,VDMOS technology.This latest technology has been especially designed to minimize on -state resistance,have a high rugged avalanche characteristics. This devices is specially well suited for high efficiency switch mode power supply , electronic lamp ballasts based on half bridge and UPS.

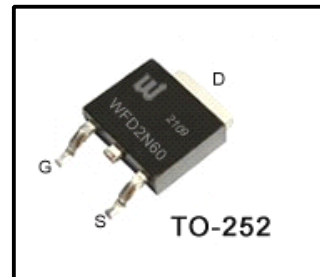

Absolute Maximum Ratings

Symbol	Parameter	Value	Units
V_{DSS}	Drain Source Voltage	600	V
I_D	Continuous Drain Current(@ $T_c=25^{\circ}C$)	2.0	A
	Continuous Drain Current(@ $T_c=100^{\circ}C$)	1.3	A
I_{DM}	Drain Current Pulsed (Note1)	6.0	A
V_{GS}	Gate to Source Voltage	± 30	V
E_{AS}	Single Pulsed Avalanche Energy (Note2)	120	mJ
E_{AR}	Repetitive Avalanche Energy (Note1)	54	mJ
dv/dt	Peak Diode Recovery dv /dt (Note3)	4.5	V/ ns
P_D	Total Power Dissipation(@ $T_c=25^{\circ}C$)	46	W
	Derating Factor above 25°C	0.35	W/°C
T_J, T_{stg}	Junction and Storage Temperature	-55~150	°C
T_L	Channel Temperature	300	°C

Thermal Characteristics

Symbol	Parameter	Value			Units
		Min	Typ	Max	
R_{QJC}	Thermal Resistance , Junction -to -Case	-	-	2.7	°C/W
R_{QCS}	Thermal Resistance , Case-to-Sink	0.5	-	-	°C/W
R_{QJA}	Thermal Resistance , Junction-to -Ambient	-	-	62.5	°C/W

Electrical Characteristics(Tc=25°C)

Characteristics		Symbol	Test Condition	Min	Type	Max	Unit
Gate leakage current		I _{GSS}	V _{GS} =±30V, V _{DS} =0V	-	-	±100	nA
Gate-source breakdown voltage		V _{(BR)GSS}	I _G =±10 μA, V _{DS} =0V	±30	-	-	V
Drain cut -off current		I _{DSS}	V _{DS} =600V, V _{GS} =0V	-	-	10	μA
			V _{DS} =480V, Tc=125°C	-	-	100	μA
Drain -source breakdown voltage		V _{(BR)DSS}	I _D =250 μA, V _{GS} =0V	600	-	-	V
Gate threshold voltage		V _{GS(th)}	V _{DS} =10V, I _D =250 μA	2	-	4	V
Drain -source ON resistance		R _{DS(ON)}	V _{GS} =10V, I _D =1A	-	3.8	5.0	Ω
Forward Transconductance		g _{fs}	V _{DS} =50V, I _D =1A	-	2.05	-	S
Input capacitance		C _{iss}	V _{DS} =25V, V _{GS} =0V, f=1MHz	-	380	490	pF
Reverse transfer capacitance		C _{rss}		-	7.6	9.9	
Output capacitance		C _{oss}		-	35	46	
Switching time	Rise time	t _r	V _{DD} =300V, I _D =2A, R _G =25Ω, (Note4,5)	-	16	40	ns
	Turn-on time	t _{on}		-	50	110	
	Fall time	t _f		-	40	90	
	Turn-off time	t _{off}		-	40	90	
Total gate charge(gate-source plus gate-drain)		Q _g	V _{DD} =320V, V _{GS} =10V, I _D =2A (Note4,5)	-	15.3	19	nC
Gate-source charge		Q _{gs}		-	1.8	-	
Gate-drain("miller") Charge		Q _{gd}		-	7.2	-	

Source-Drain Ratings and Characteristics(Ta=25°C)

Characteristics	Symbol	Test Condition	Min	Type	Max	Unit
Continuous drain reverse current	I _{DR}	-	-	-	2.0	A
Pulse drain reverse current	I _{DRP}	-	-	-	6.0	A
Forward voltage(diode)	V _{DSF}	I _{DR} =2.0A, V _{GS} =0V	-	-	1.4	V
Reverse recovery time	t _{rr}	I _{DR} =2.0A, V _{GS} =0V,	-	250	-	ns
Reverse recovery charge	Q _{rr}	dI _{DR} / dt =100 A / μs	-	1.31	-	μC

Note 1.Repeativity rating :pulse width limited by junction temperature

2. L=55mH I_{AS}=2A, V_{DD}=50V, R_G=0Ω ,Starting T_J=25°C

3. I_{SD}≤2A, di/dt≤200A/μs, V_{DD}<BV_{DSS}, STARTING T_J=25°C

4. Pulse Test:Pulse Width≤300us, Duty Cycle≤2%

5. Essentially independent of operating temperature.

This transistor is an electrostatic sensitive device

Please handle with caution

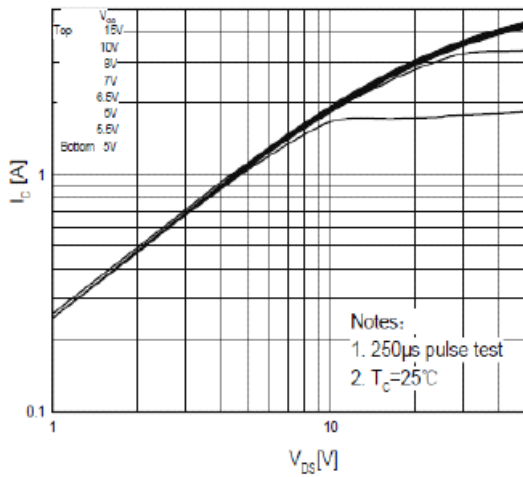

Fig.1 On-State Characteristics

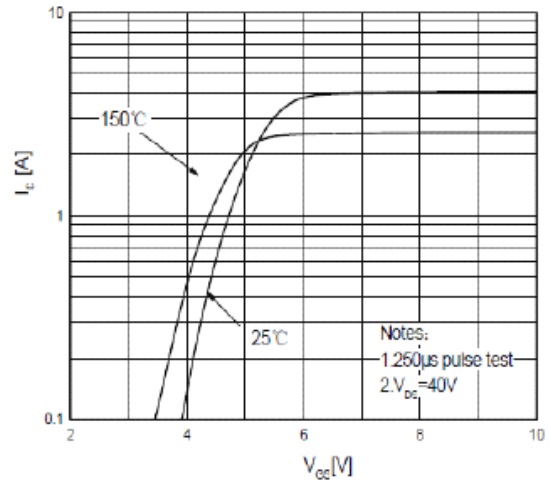

Fig.2 Transfer Current characteristics

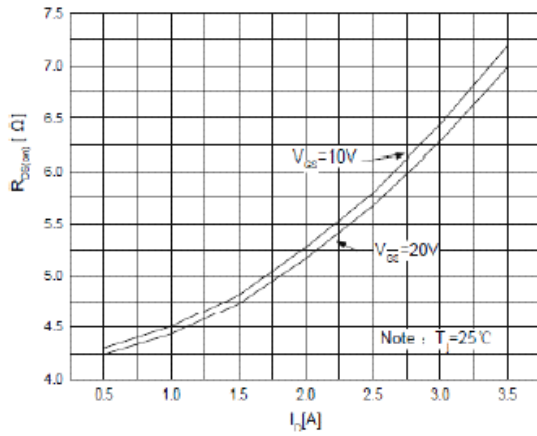

Fig.3 On Resistance variation vs Drain Current

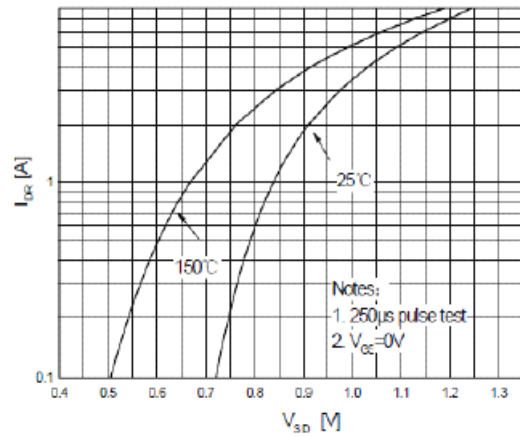

Fig.4 Body Diode Forward Voltage Variation With Source Current And temperature

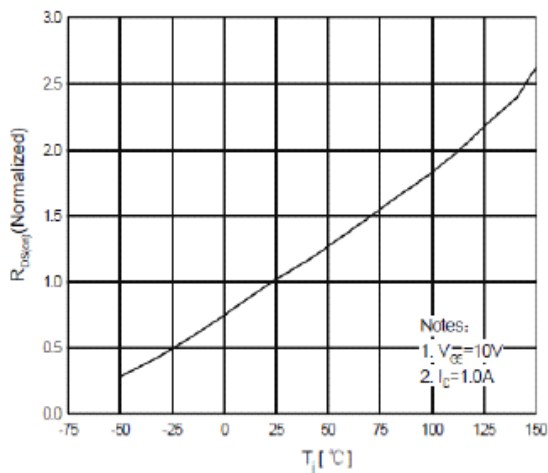

Fig.5 On-Resistance Variation vs Junction Temperature

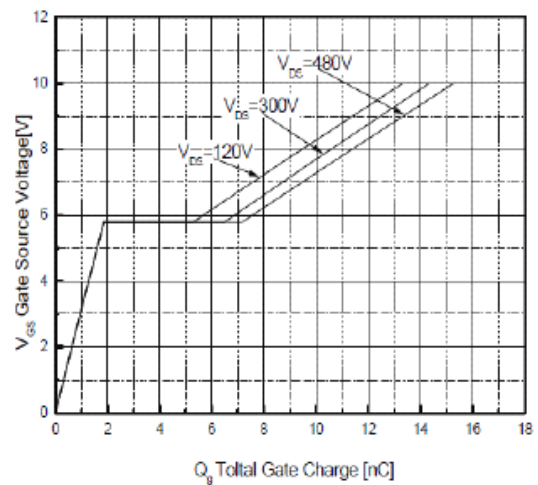

Fig.6 Gate Charge Characteristics

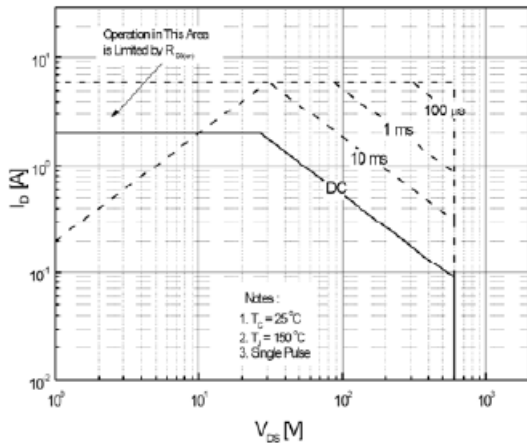

Fig.7 Maximum Safe Operation Area

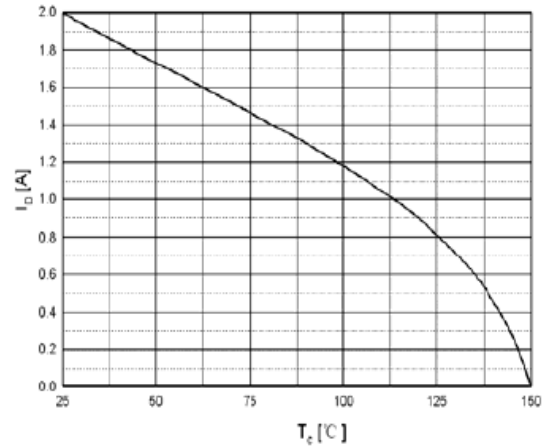

Fig.8 Maximum Drain Current vs Case Temperature

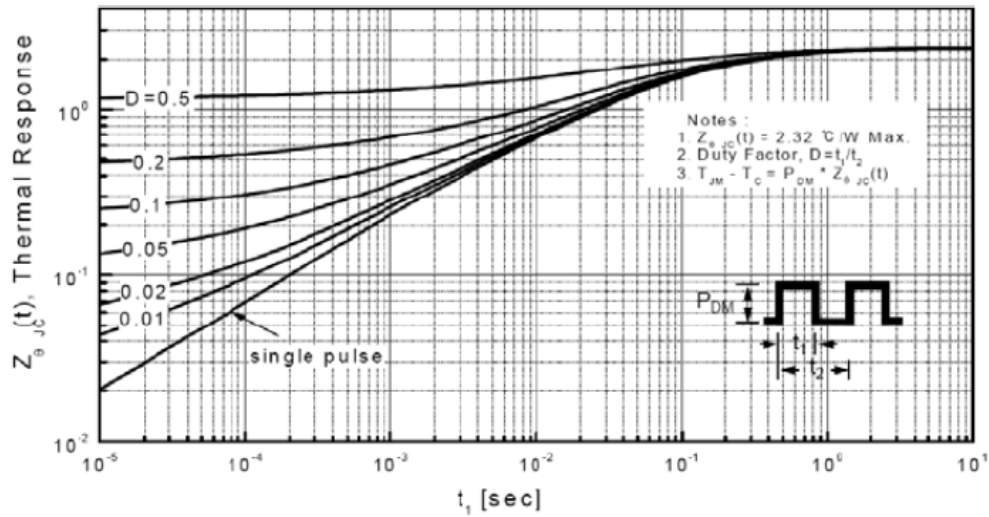

Fig.9 Transient Thermal Response curve

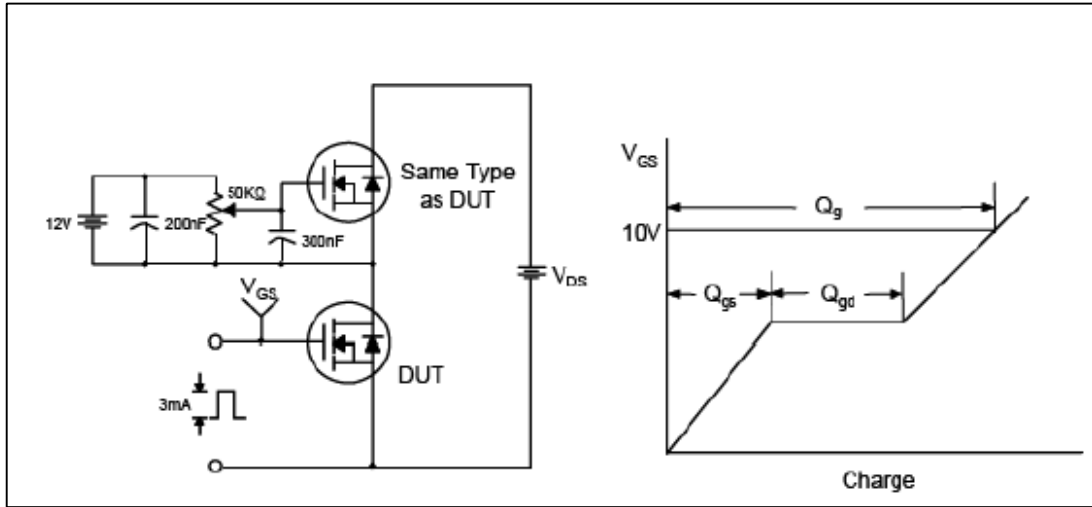

Fig.10 Gate Test circuit & Waveform

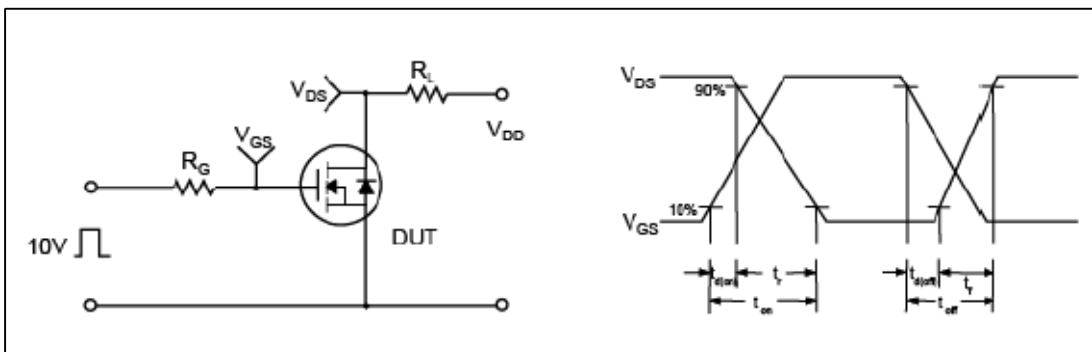

Fig.11 Resistive Switching Test Circuit & Waveform

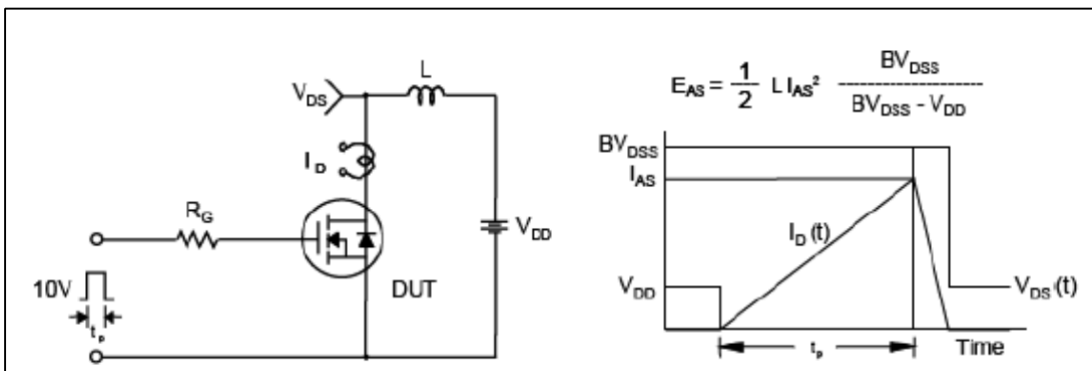

Fig.12 Uncamped Inductive Switching Test Circuit & Waveform

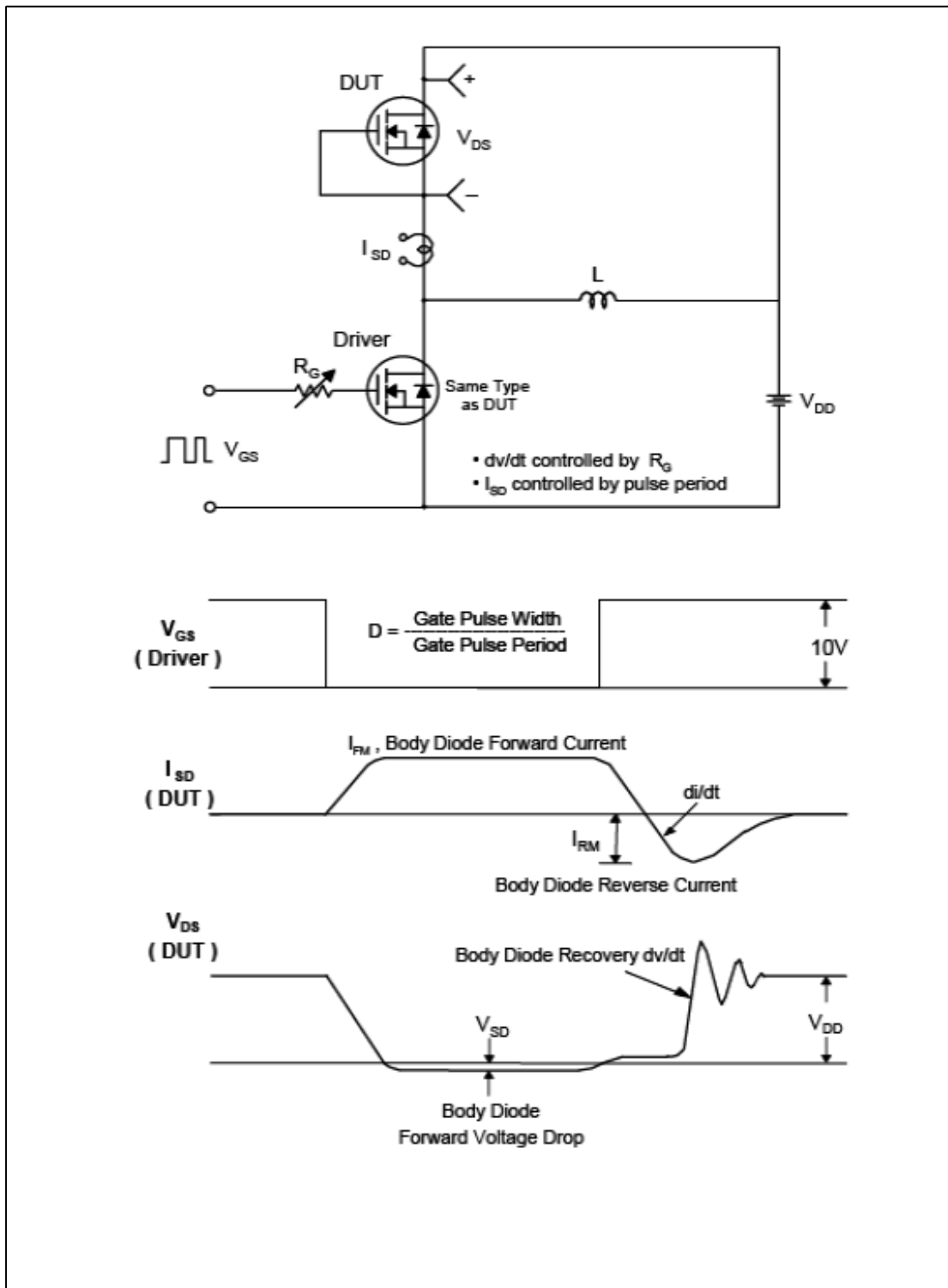

Fig.13 Peak Diode Recovery dv/dt Test Circuit & Waveform

TO252 Package Dimension

Unit:mm

