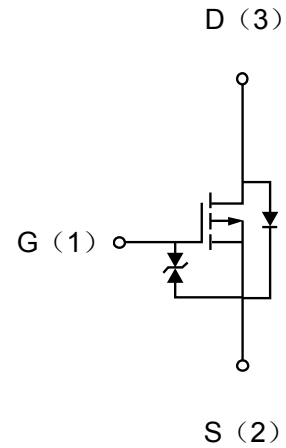

Description

The MOSFET provide the best combination of fast switching, low on-resistance and cost-effectiveness.

MOSFET Product Summary		
$V_{DS}(V)$	$R_{DS(on)}(\Omega)$	$I_D(mA)$
-20	0.6@ $V_{GS}=-4.5V$	±300
	0.9@ $V_{GS}=-2.5V$	
	1.5@ $V_{GS}=-1.8V$	

Absolute maximum rating@25°C

Parameter		Symbol	Value	Units
Drain-Source Voltage		V_{DS}	-20	V
Gate-Source Voltage		V_{GS}	±10	V
Continuous Drain Current($T_J=150^\circ C$)	Continuous	I_D	±300	mA
	Pulsed	I_{DP}	±800	
Source current(Body diode)	Continuous	I_S	-100	mA
	Pulsed	I_{SP}	-800	
Total power dissipation		P_D	150	mW
Channel temperature		T_{CH}	150	°C
Range of storage temperature		T_{STG}	-55 to +150	°C

Thermal resistance

Parameter	Symbol	Limits	Units
Channel to ambient	$R_{th}(ch-a)$	833	°C/W

Electrical characteristics per line@25°C (unless otherwise specified)

Parameter	Symbol	Conditions	Min.	Typ.	Max.	Units
Drain-Source Breakdown Voltage	BV_{DSS}	$I_D = -1mA, V_{GS} = 0V$	-20		-	V
Zero Gate Voltage Drain Current	I_{DSS}	$V_{DS} = -20V, V_{GS} = 0V$	-	-	-1	μA
Gate-Body Leakage Current	I_{GSS}	$V_{DS} = 0V, V_{GS} = \pm 8V$	-	-	± 10	μA
Gate Threshold Voltage	$V_{GS(th)}$	$V_{DS} = -10V, I_D = -100\mu A$	-0.5	-	-1.1	V
Static Drain-Source On-Resistance	$R_{DS(on)}$	$V_{GS} = -4.5V, I_D = -300mA$	-	0.6	1.0	Ω
		$V_{GS} = -2.5V, I_D = -200mA$	-	0.9	1.5	Ω
		$V_{GS} = -1.8V, I_D = -100mA$		1.5	2.2	Ω
Forward transfer admittance	$ Y_{fs} $	$V_{DS} = -10V, I_D = -200mA$	0.3			s
Input Capacitance	C_{ISS}	$V_{GS} = 0V, V_{DS} = -10V,$ $f = 1MHz$	-	110		pF
Output Capacitance	C_{OSS}		-	9		pF
Reverse Transfer Capacitance	C_{RSS}		-	5		pF
Turn-On Delay Time	$t_{d(on)}$	$V_{DD} = -10V, V_{GS} = -4.5V,$ $R_G = 10\Omega, R_L = 100\Omega$ $I_D = -100mA$	-	5		ns
Turn-Off Delay Time	$t_{d(off)}$		-	15		ns
Turn-On Rise Time	t_r		-	4		ns
Turn-On Fall Time	t_f		-	13		ns
Total Gate Charge	Q_g	$V_{DD} = -10V, V_{GS} = -4.5V,$ $I_D = -200mA$ $R_G = 10\Omega, R_L = 50\Omega$		1.4		nC
Gate-Source Charge	Q_{gs}			0.3		nC
Gate-Drain Charge	Q_{gd}			0.3		nC
Drain-Source Diode Forward Voltage	V_{SD}	$V_{GS} = 0V, I_S = -200mA$		-	-1.2	V

Typical Characteristics

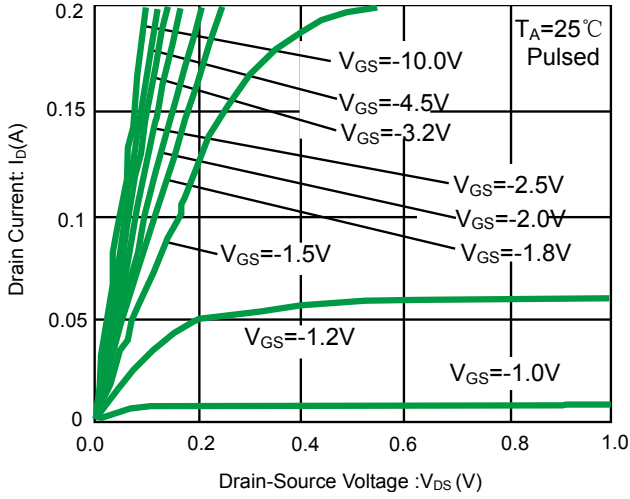

Fig 1. Typical output characteristics(I)

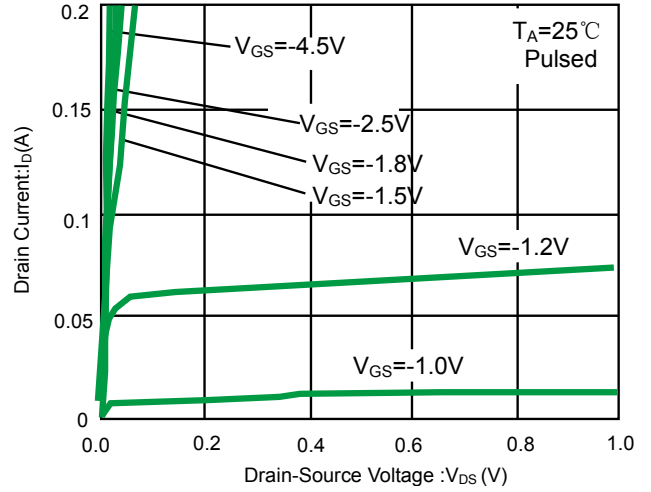

Fig 2. Typical output characteristics(II)

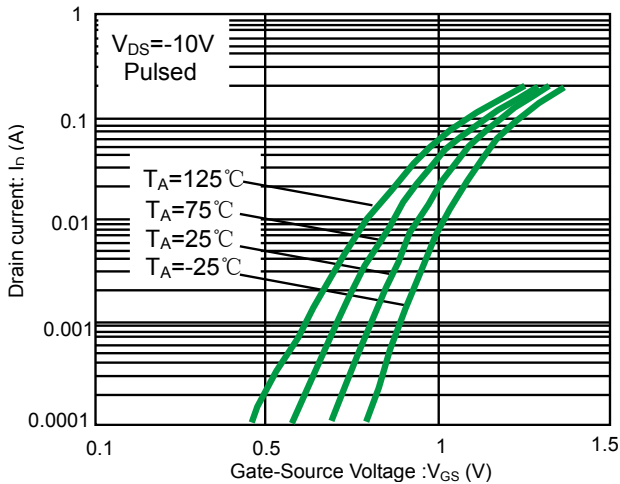

Fig 3. Typical transfer characteristics

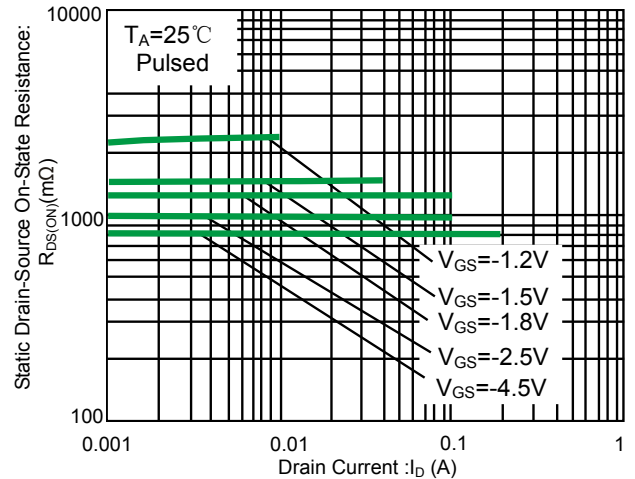

Fig 4. Static drain-source on-state resistance vs. drain current(I)

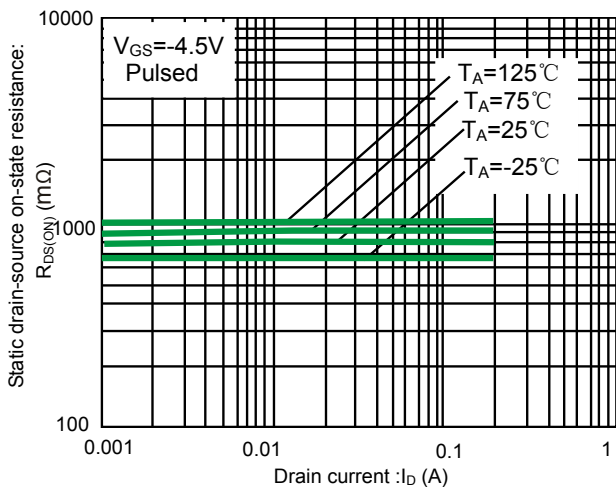

Fig 5. Static drain-source on-state resistance vs. drain current(II)

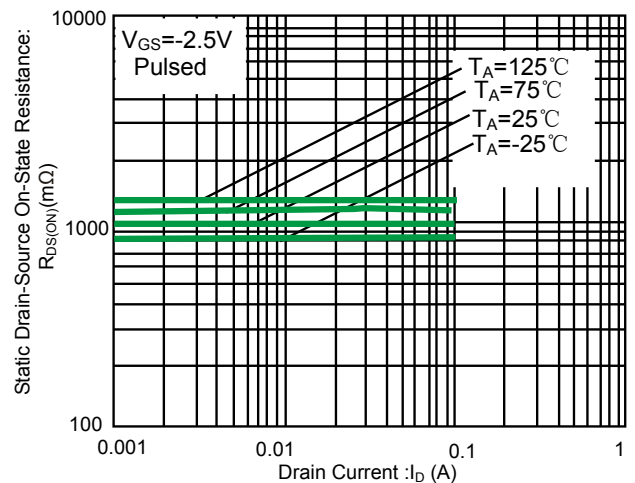

Fig 6. Static drain-source on-state resistance vs. drain current(III)

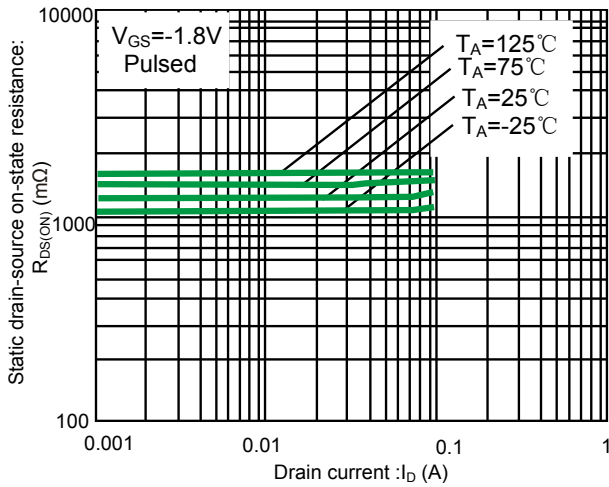

Fig 7. Static drain-source on-state resistance vs. drain current(IV)

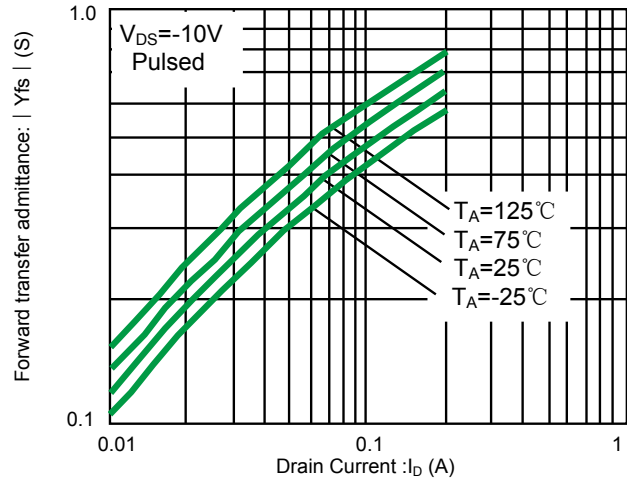

Fig 8. Forward transfer admittance vs. drain current

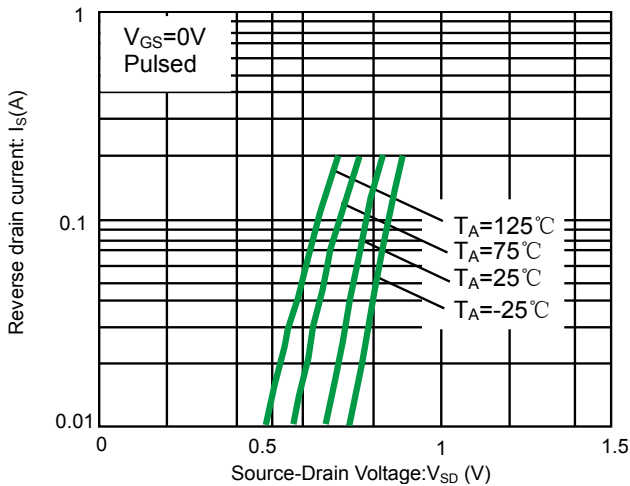

Fig 9. Reverse drain current vs. source-drain voltage

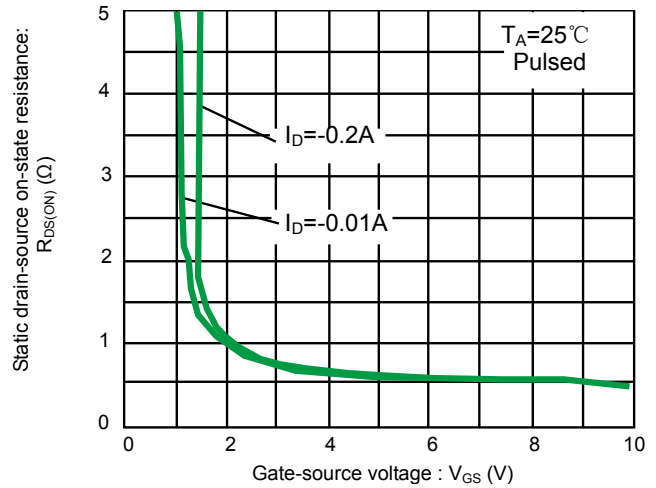

Fig 10. Static drain-source on-state resistance vs. gate source voltage

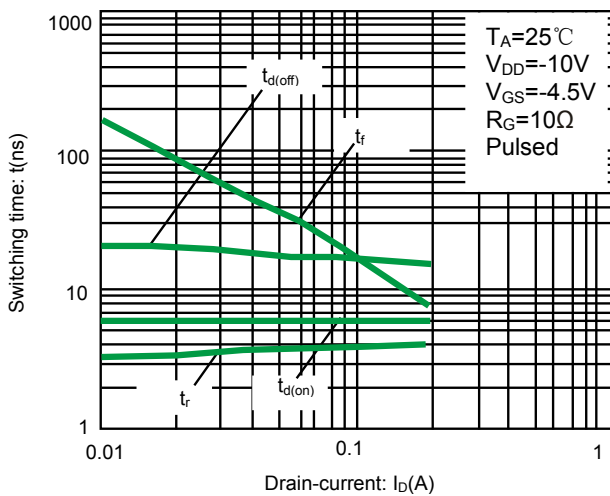

Fig 11. Switching characteristics

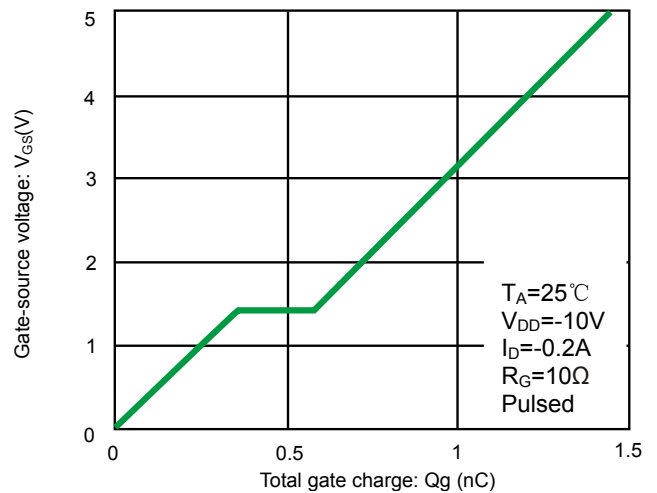

Fig 12. Dynamic input characteristics

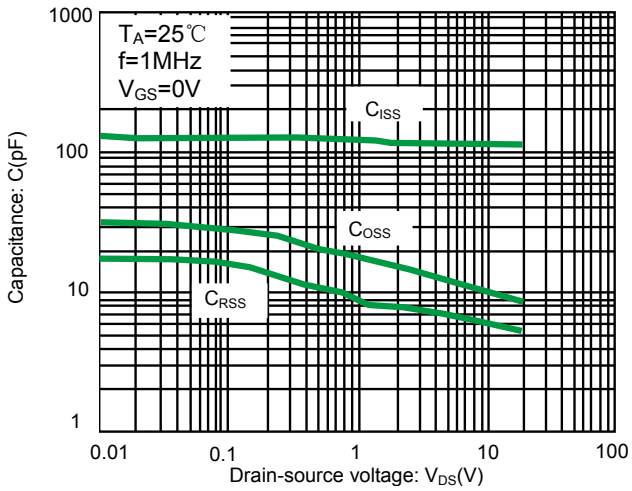

Fig 13. Typical capacitance vs. drain-source voltage

Measurement circuit

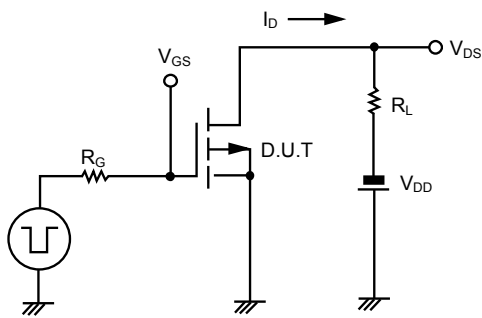

Fig.1-1 Switching time measurement circuit

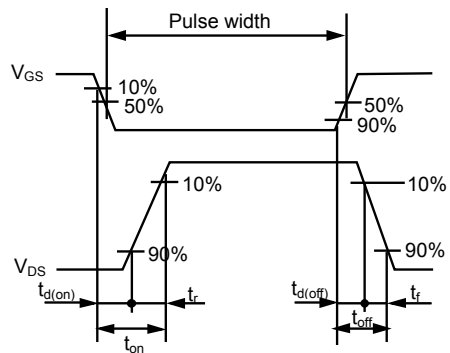

Fig.1-2 Switching time waveforms

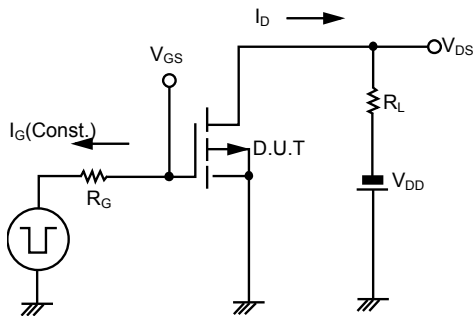

Fig.2-1 Gate charge measurement circuit

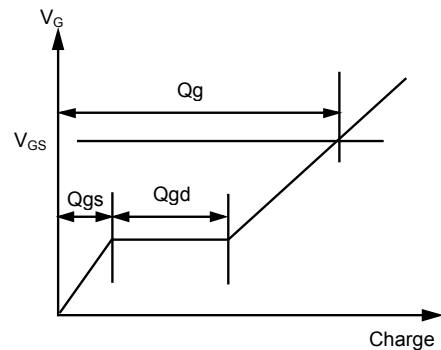
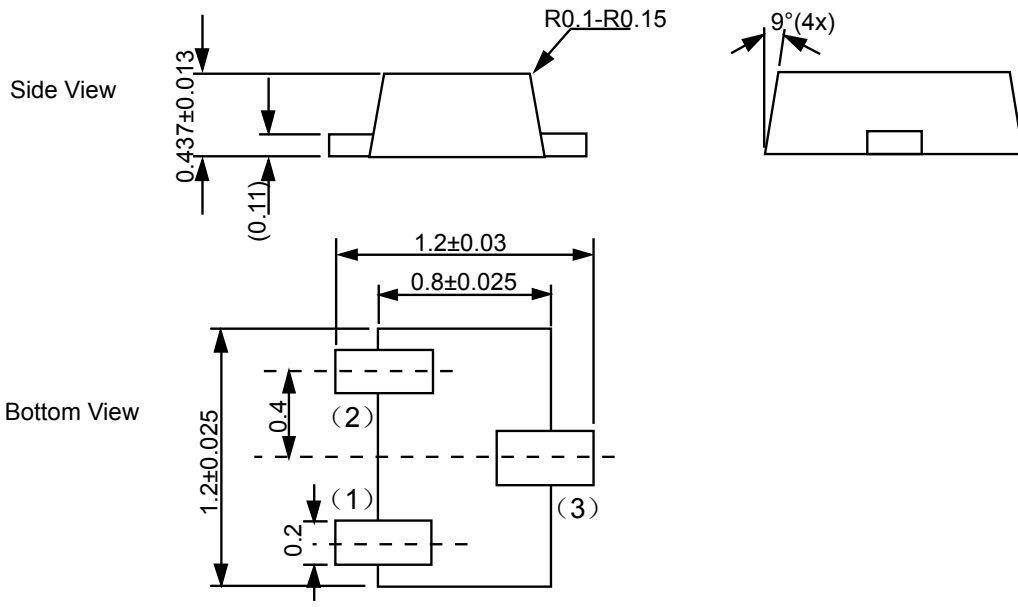
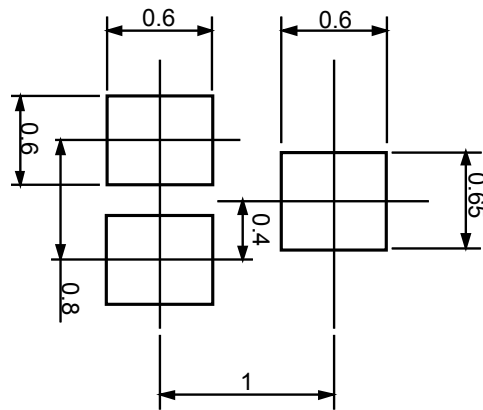

Fig.2-2 Gate charge waveform

Product dimension (SOT-723)



Unit: mm



Unit: mm

Ordering information

Device	Package	Shipping
PPM723T201E0	SOT-723 (Pb-Free)	10000 / Tape & Reel

IMPORTANT NOTICE

 and **Prisemi**[®] are registered trademarks of **Prisemi Electronics Co., Ltd (Prisemi)** ,Prisemi reserves the right to make changes without further notice to any products herein. Prisemi makes no warranty, representation or guarantee regarding the suitability of its products for any particular purpose, nor does Prisemi assume any liability arising out of the application or use of any product or circuit, and specifically disclaims any and all liability, including without limitation special, consequential or incidental damages. “Typical” parameters which may be provided in Prisemi data sheets and/or specifications can and do vary in different applications and actual performance may vary over time. All operating parameters, including “Typicals” must be validated for each customer application by customer’s technical experts. Prisemi does not convey any license under its patent rights nor the rights of others. The products listed in this document are designed to be used with ordinary electronic equipment or devices, Should you intend to use these products with equipment or devices which require an extremely high level of reliability and the malfunction of with would directly endanger human life (such as medical instruments, aerospace machinery, nuclear-reactor controllers, fuel controllers and other safety devices), please be sure to consult with our sales representative in advance.

Website: <http://www.prisemi.com>

For additional information, please contact your local Sales Representative.

©Copyright 2009, Prisemi Electronics

 **Prisemi**[®] is a registered trademark of Prisemi Electronics.

All rights are reserved.