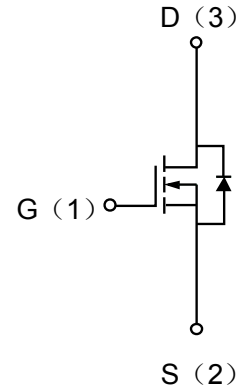

Description

The enhancement mode MOS is extremely high density cell and low on-resistance.

MOSFET Product Summary		
$V_{DS}(V)$	$R_{DS(on)}(\Omega)$	$I_D(A)$
20	0.3@ $V_{GS}=4.5V$	0.6

Electrical characteristics per line@25°C (unless otherwise specified)

Parameter	Symbol	Conditions	Min.	Typ.	Max.	Units
OFF CHARACTERISTICS						
Drain-Source Breakdown Voltage	BV_{DSS}	$I_D=250\mu A, V_{GS}=0V$	20		-	V
Zero Gate Voltage Drain Current	I_{DSS}	$V_{DS}=20V, V_{GS}=0V$	-	-	1	μA
Gate-Body Leakage Current	I_{GSS}	$V_{DS}=0V, V_{GS}=\pm 10V$	-	-	± 100	nA
Gate Threshold Voltage	$V_{GS(th)}$	$V_{DS}=V_{GS}, I_D=250\mu A$	0.5		0.85	V
Static Drain-Source On-Resistance	$R_{DS(ON)}$	$V_{GS}=4.5V, I_D=0.6A$	-	0.3	0.35	Ω
		$V_{GS}=2.5V, I_D=0.5A$	-	0.5	0.55	Ω
		$V_{GS}=1.8V, I_D=0.35A$	-	0.6	0.85	Ω
DYNAMIC PARAMETERS						
Input Capacitance	C_{ISS}	$V_{GS}=0V, V_{DS}=16V,$ $f=1MHz$	-	135		pF
Output Capacitance	C_{DSS}		-	23		pF
Reverse Transfer Capacitance	C_{RSS}		-	18		pF
SWITCHING PARAMETERS						
Turn-On Delay Time	$t_{d(on)}$	$V_{DS}=10V, V_{GS}=4.5V,$ $R_G=10\Omega,$ $I_D=0.2A$	-		15	ns
Turn-Off Delay Time	$t_{d(off)}$		-		55	ns

Absolute maximum rating@25°C

Rating		Symbol	Value	Units
Drain-Source Voltage		V_{DS}	20	V
Gate-Source Voltage		V_{GS}	± 12	V
Drain Current	Continuous	I_D	0.6	A
	Pulsed	I_D	3.0	A
Total Power Dissipation	$T_A=25^\circ\text{C}$	P_D	170	mW
	$T_A=125^\circ\text{C}$	P_D	155	mW

Typical Characteristics

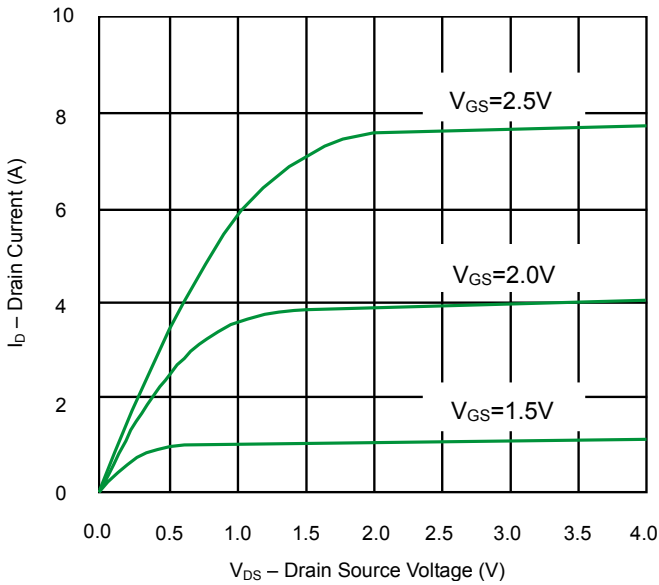

Fig 1. Output Characteristics

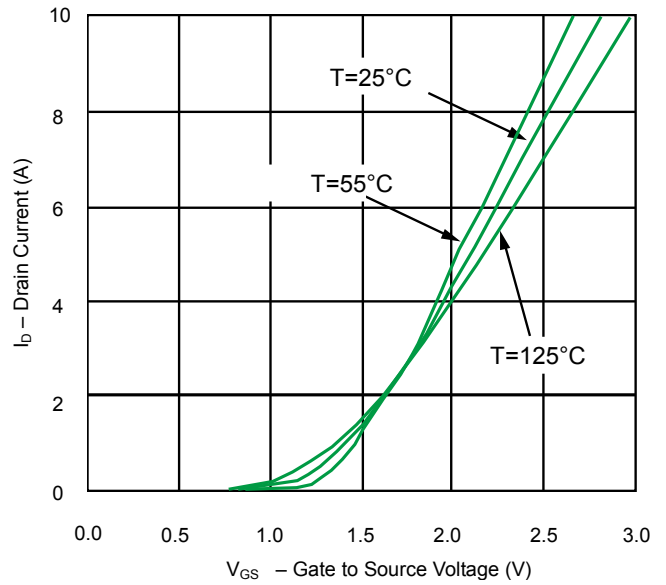

Fig 2. Transfer Characteristics

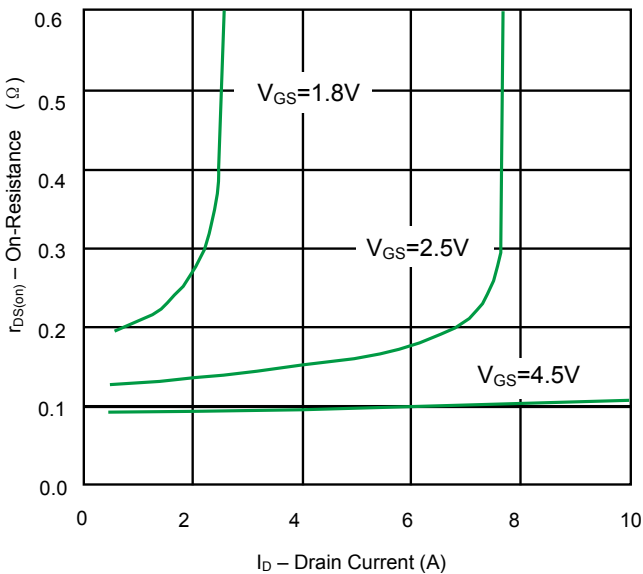

Fig 3. On-Resistance vs. Drain Current

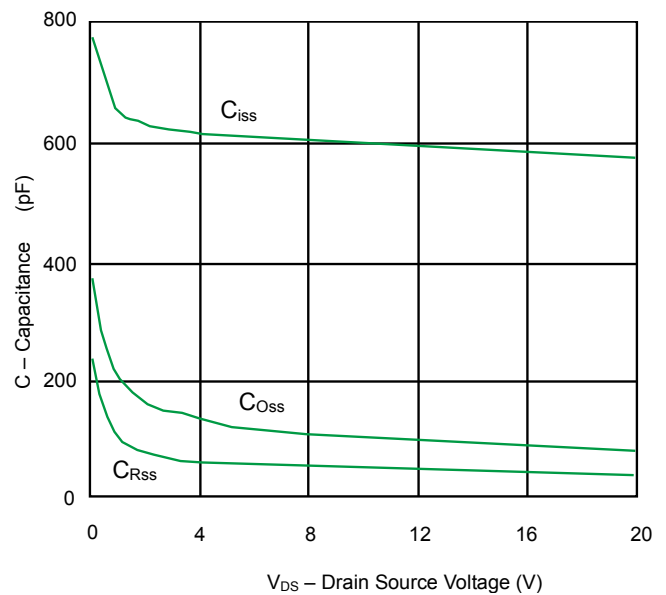
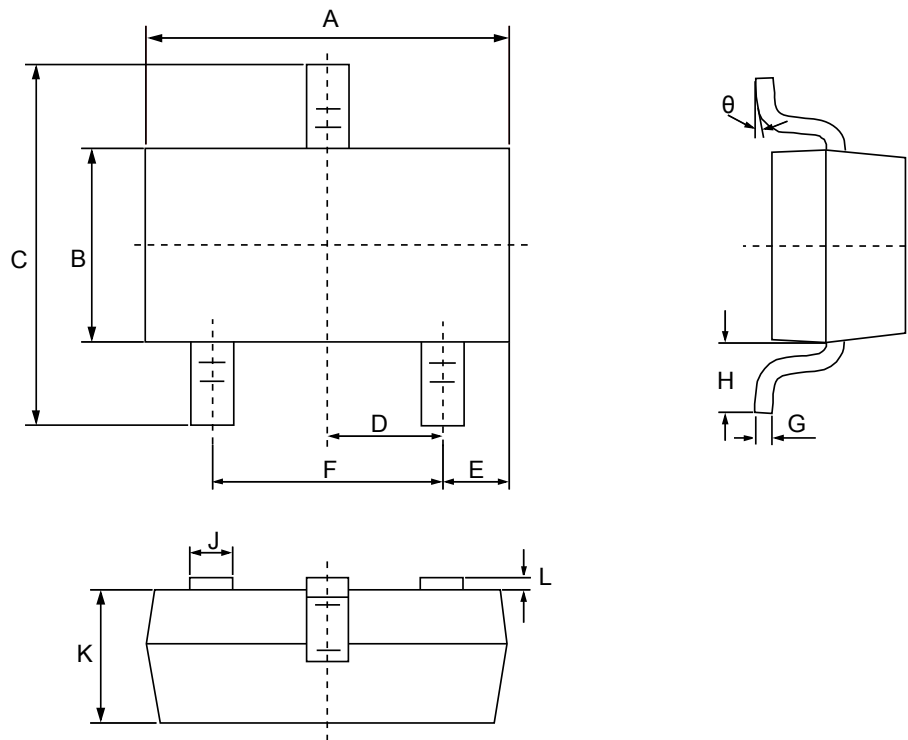



Fig 4. Capacitance

Product dimension (SOT-323)



Dim	Millimeters		Inches	
	MIN	MAX	MIN	MAX
A	1.80	2.20	0.071	0.087
B	1.15	1.35	0.045	0.053
C	2.00	2.40	0.079	0.095
D	0.65BSC		0.026BSC	
E	0.45	0.60	0.0177	0.0236
F	1.20	1.40	0.047	0.055
G	0.10	0.25	0.004	0.010
H	0.425REF		0.017REF	
J	0.30	0.40	0.012	0.016
K	0.7REF		0.028REF	
L	0.013	0.100	0.0005	0.0040
θ	0°	10°	0°	10°

IMPORTANT NOTICE

 and **Prisemi**[®] are registered trademarks of **Prisemi Electronics Co., Ltd (Prisemi)** ,Prisemi reserves the right to make changes without further notice to any products herein. Prisemi makes no warranty, representation or guarantee regarding the suitability of its products for any particular purpose, nor does Prisemi assume any liability arising out of the application or use of any product or circuit, and specifically disclaims any and all liability, including without limitation special, consequential or incidental damages. “Typical” parameters which may be provided in Prisemi data sheets and/or specifications can and do vary in different applications and actual performance may vary over time. All operating parameters, including “Typicals” must be validated for each customer application by customer’s technical experts. Prisemi does not convey any license under its patent rights nor the rights of others. The products listed in this document are designed to be used with ordinary electronic equipment or devices, Should you intend to use these products with equipment or devices which require an extremely high level of reliability and the malfunction of with would directly endanger human life (such as medical instruments, aerospace machinery, nuclear-reactor controllers, fuel controllers and other safety devices), please be sure to consult with our sales representative in advance.

Website: <http://www.prisemi.com>

For additional information, please contact your local Sales Representative.

©Copyright 2009, Prisemi Electronics

 **Prisemi**[®] is a registered trademark of Prisemi Electronics.

All rights are reserved.