

Portable Equipment Application

Features

- Low drain-source On-resistance:
 $R_{DS(on)}=72m\Omega$ (Max.) @ $V_{GS}=-10V$, $I_D=-2.7A$
- Low gate charge: $Q_g=4.7nC$ (Typ.)
- High power and current handling capability
- RoHS compliant device



SOP-8

Ordering Information

Part Number	Marking Code	Package	Packaging
STJ009	STJ009	SOP-8	Tape & Reel

Marking and Pin Assignment

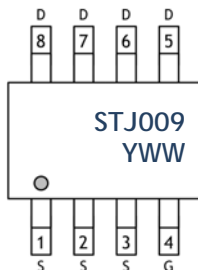

Column 1: Device Code
 Column 2: Production Information
 - YWW: Year & Week Code

Absolute Maximum Ratings ($T_{amb}=25^{\circ}C$, Unless otherwise noted)

Characteristic	Symbol	Ratings	Unit
Drain-source voltage	V_{DSS}	-30	V
Gate-source voltage	V_{GSS}	± 16	V
Drain current (DC) ¹⁾	I_D	-5.3	A
Drain current (Pulsed) ¹⁾	I_{DP}	-21.2	A
Power dissipation	P_D	2	W
Single avalanche current ⁴⁾	I_{AS}	-5.3	A
Single avalanche energy ⁴⁾	E_{AS}	33	mJ
Repetitive avalanche current ³⁾	I_{AR}	-5.3	A
Repetitive avalanche energy ³⁾	E_{AR}	1.6	mJ
Operating junction temperature	T_j	150	$^{\circ}C$
Storage temperature range	T_{stg}	-55 ~ 150	$^{\circ}C$

Note 1) Limited by maximum junction temperature

Thermal Characteristics ($T_{amb}=25^{\circ}\text{C}$, Unless otherwise noted)

Characteristic	Symbol	Ratings	Unit
Thermal resistance, junction to ambient ²⁾	$R_{th(j-a)}$	62.5	$^{\circ}\text{C}/\text{W}$

Note 2) Device mounted on FR-4 board with recommended pad layout.

Electrical Characteristics ($T_{amb}=25^{\circ}\text{C}$, Unless otherwise noted)

Characteristic	Symbol	Test Condition	Min.	Typ.	Max.	Unit
Drain-source breakdown voltage	BV_{DSS}	$I_D=-250\mu\text{A}$, $V_{GS}=0$	-30	-	-	V
Gate threshold voltage	$V_{GS(th)}$	$I_D=-250\mu\text{A}$, $V_{DS}=V_{GS}$	-1	-	-3	V
Drain-source cut-off current	I_{DSS}	$V_{DS}=-30\text{V}$, $V_{GS}=0\text{V}$	-	-	-1	μA
Gate leakage current	I_{GSS}	$V_{DS}=0\text{V}$, $V_{GS}=\pm 20\text{V}$	-	-	± 100	nA
Drain-source on-resistance	$R_{DS(on)}$	$V_{GS}=-10\text{V}$, $I_D=-2.7\text{A}$	-	66	72	m Ω
		$V_{GS}=-5\text{V}$, $I_D=-2.7\text{A}$	-	77	83	
Forward transfer conductance ⁶⁾	g_{fs}	$V_{DS}=-5\text{V}$, $I_D=-5.3\text{A}$	-	11	-	S
Input capacitance	C_{iss}	$V_{GS}=0\text{V}$, $V_{DS}=-10\text{V}$, $f=1\text{MHz}$	-	390	590	pF
Output capacitance	C_{oss}		-	97	150	
Reverse transfer capacitance	C_{rss}		-	37	60	
Turn-on delay time ^{5,6)}	$t_{d(on)}$	$V_{DS}=-15\text{V}$, $I_D=-5.3\text{A}$, $R_G=10\Omega$	-	1.2	-	ns
Rise time ^{5,6)}	t_r		-	1.1	-	
Turn-off delay time ^{5,6)}	$t_{d(off)}$		-	2.5	-	
Fall time ^{5,6)}	t_f		-	1.1	-	
Total gate charge ^{5,6)}	Q_g	$V_{DS}=-15\text{V}$, $V_{GS}=-5\text{V}$, $I_D=-5.3\text{A}$	-	4.7	7	nC
Gate-source charge ^{5,6)}	Q_{gs}		-	1.4	2.1	
Gate-drain charge ^{5,6)}	Q_{gd}		-	1.7	2.5	

Source-Drain Diode Rating and Characteristics ($T_{amb}=25^{\circ}\text{C}$, Unless otherwise specified)

Characteristic	Symbol	Test Condition	Min.	Typ.	Max.	Unit
Source current (DC)	I_S	Integral reverse diode in the MOSFET	-	-	-1.5	A
Source current (Pulsed) ³⁾	I_{SM}		-	-	-6	
Forward voltage ⁶⁾	V_{SD}	$V_{GS}=0\text{V}$, $I_S=-1.5\text{A}$	-	-	-1.2	V
Reverse recovery time	t_{rr}	$I_S=-1.5\text{A}$	-	90	-	ns
Reverse recovery charge	Q_{rr}	$di_f/dt=-100\text{A}/\mu\text{s}$	-	0.5	-	μC

Note:

3) Repetitive rating: Pulse width limited by maximum junction temperature

4) $L=2\text{mH}$, $I_{AS}=-5\text{A}$, $V_{DD}=-15\text{V}$, $R_G=25\Omega$, Starting $T_J=25^{\circ}\text{C}$

5) Pulse Test: Pulse width $\leq 300\mu\text{s}$, Duty cycle $\leq 2\%$

6) Essentially independent of operating temperature

Electrical Characteristic Curves

Fig. 1 $I_D - V_{DS}$

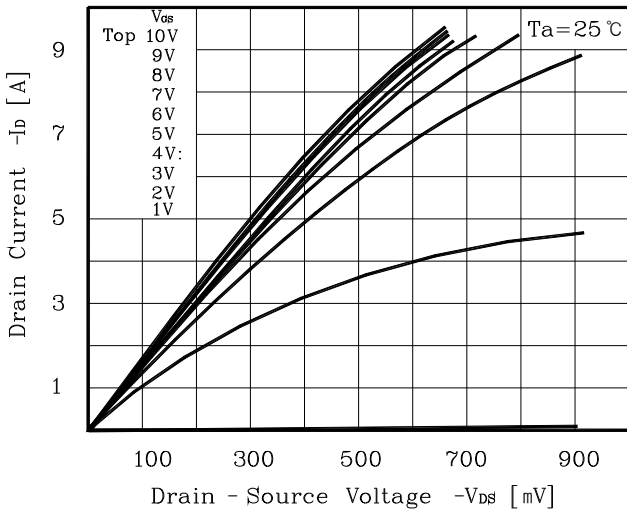

Fig. 2 $I_D - V_{GS}$

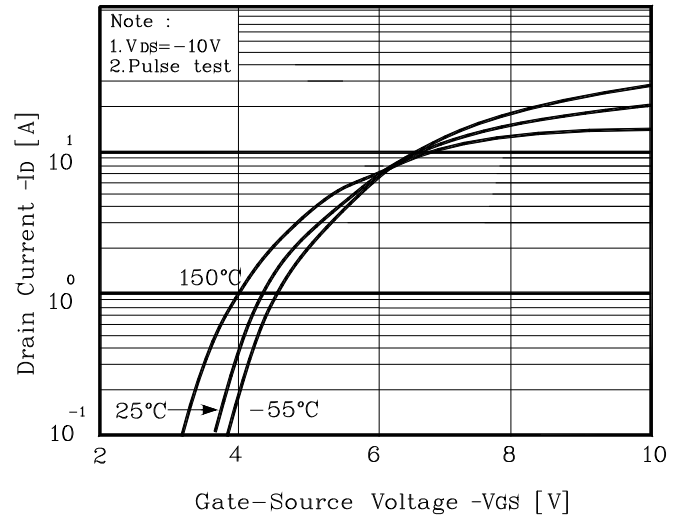

Fig. 3 $R_{DS(on)} - I_D$

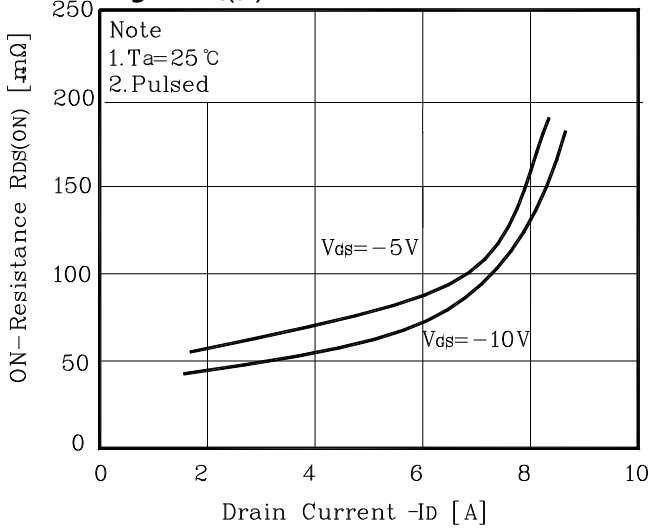

Fig. 4 $I_S - V_{SD}$

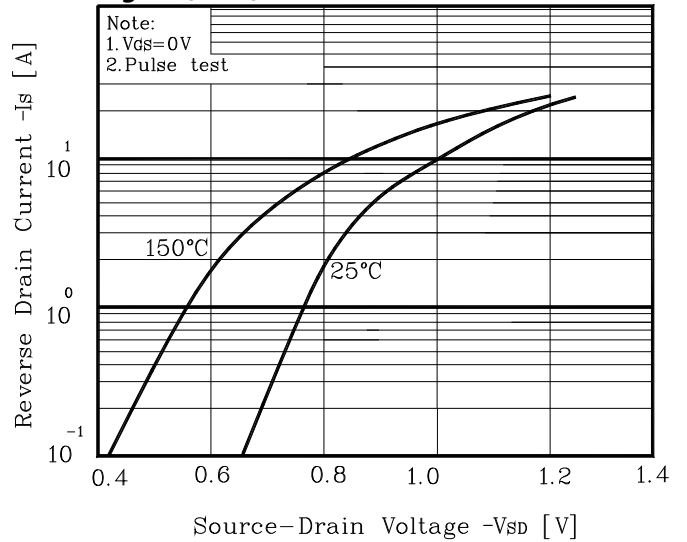

Fig. 5 Capacitance - V_{DS}

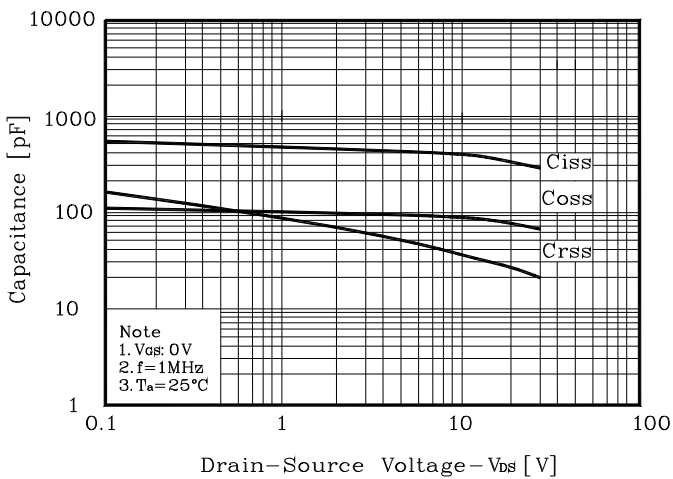
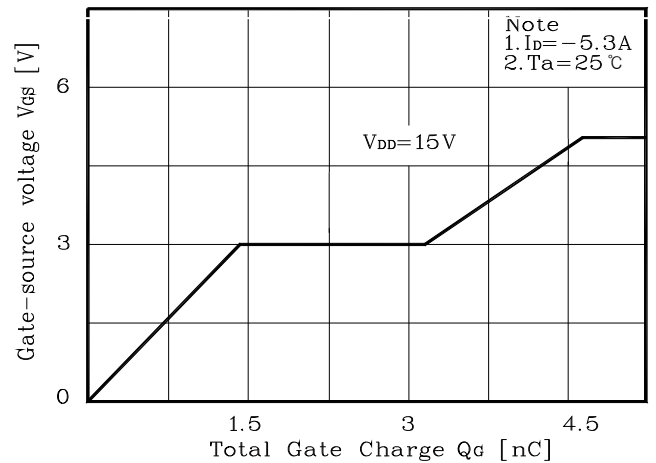

Fig. 6 $V_{GS} - Q_G$



Electrical Characteristic Curves

Fig. 7 $V_{DSS} - T_J$

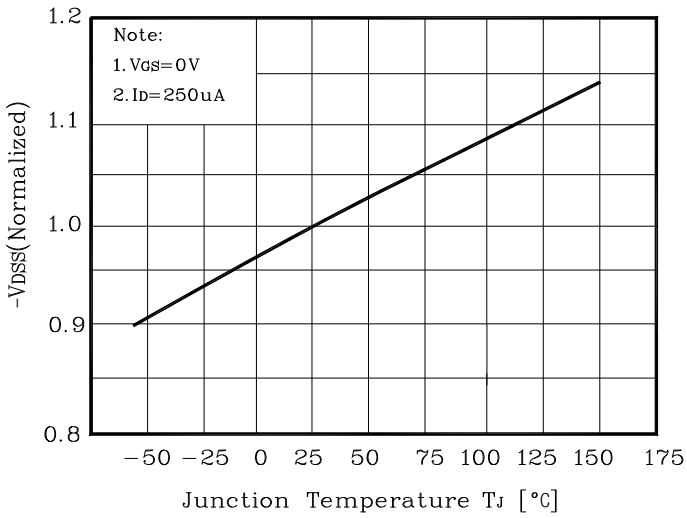

Fig. 8 $R_{DS(on)} - T_J$

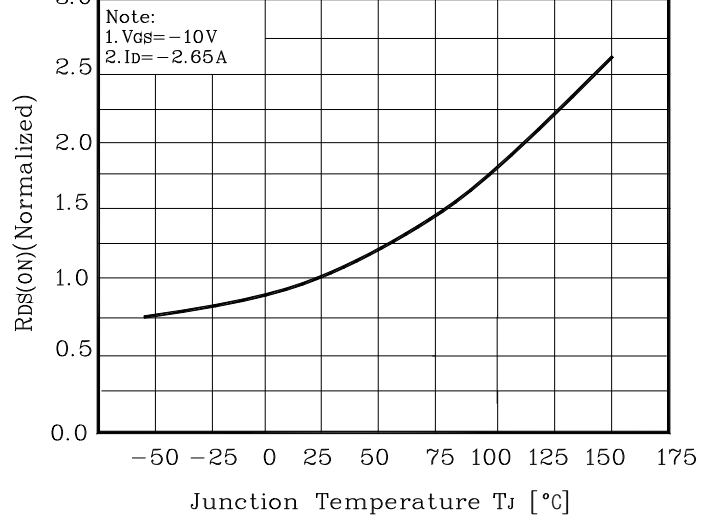

Fig. 9 $I_D - T_a$

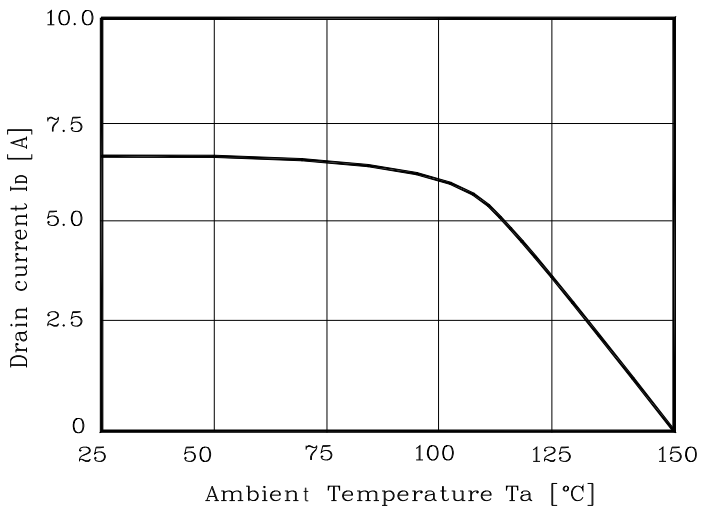

Fig. 10 Safe Operating Area

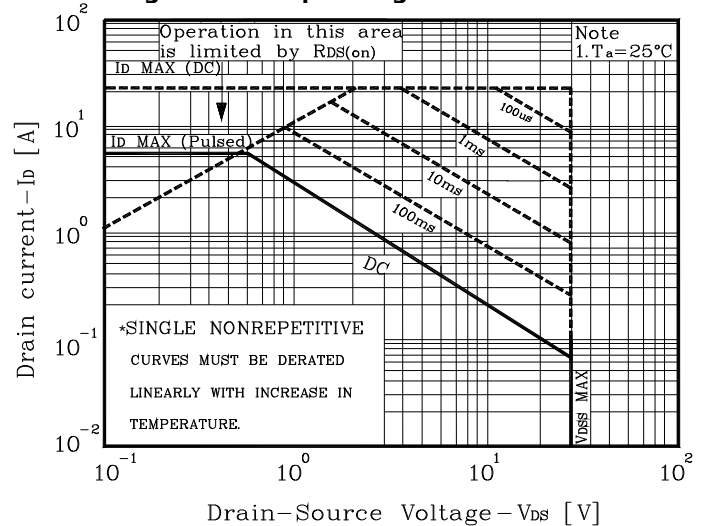

Fig. 11 Gate Charge Test Circuit & Waveform

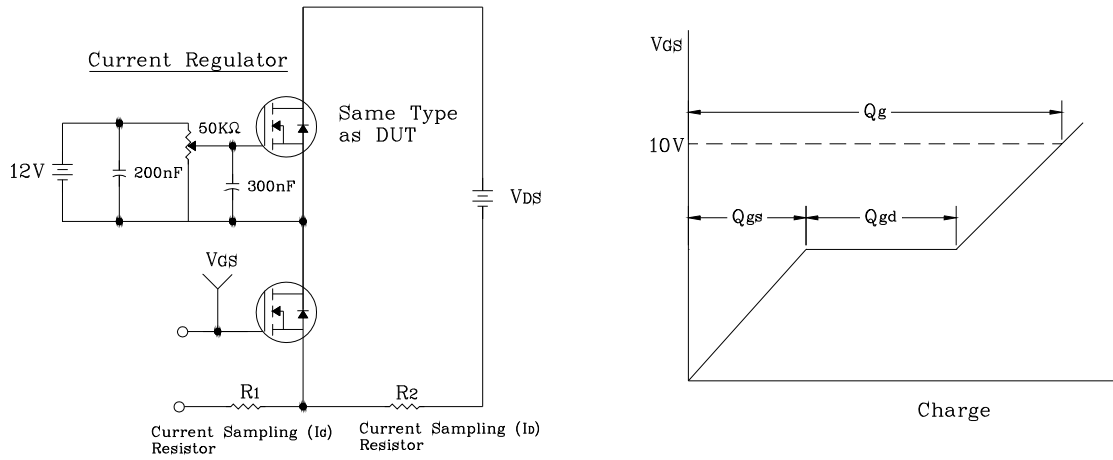

Fig. 12 Resistive Switching Test Circuit & Waveform

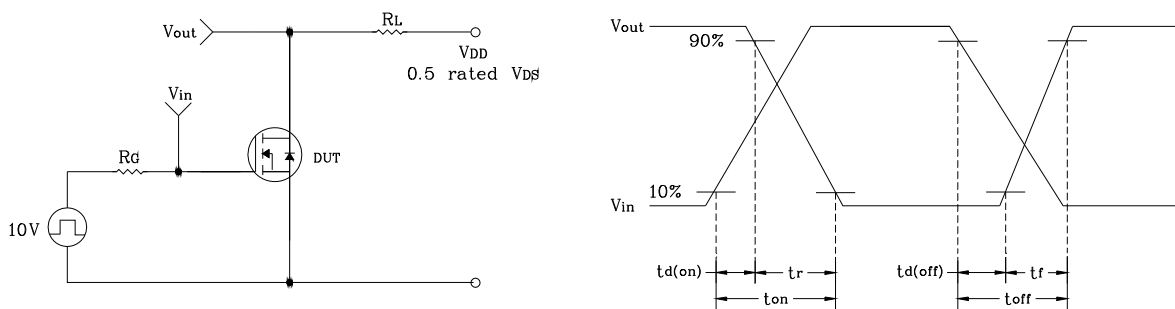

Fig. 13 E_{AS} Test Circuit & Waveform

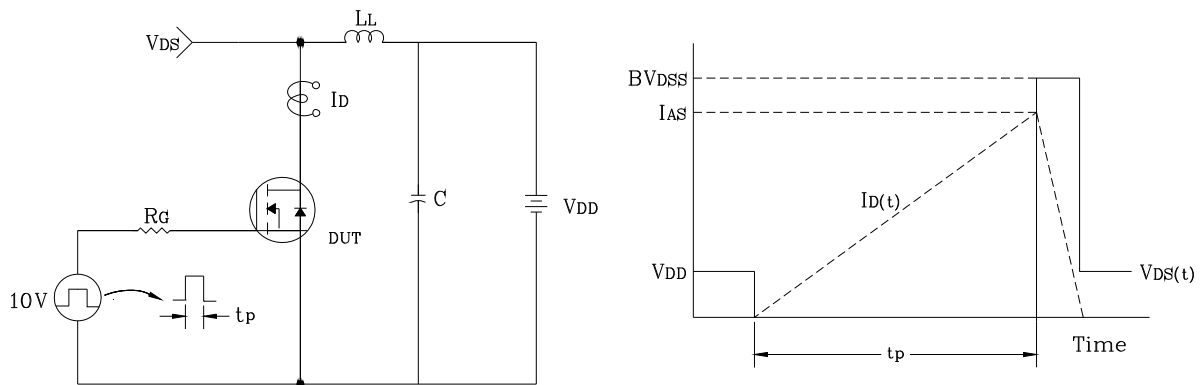
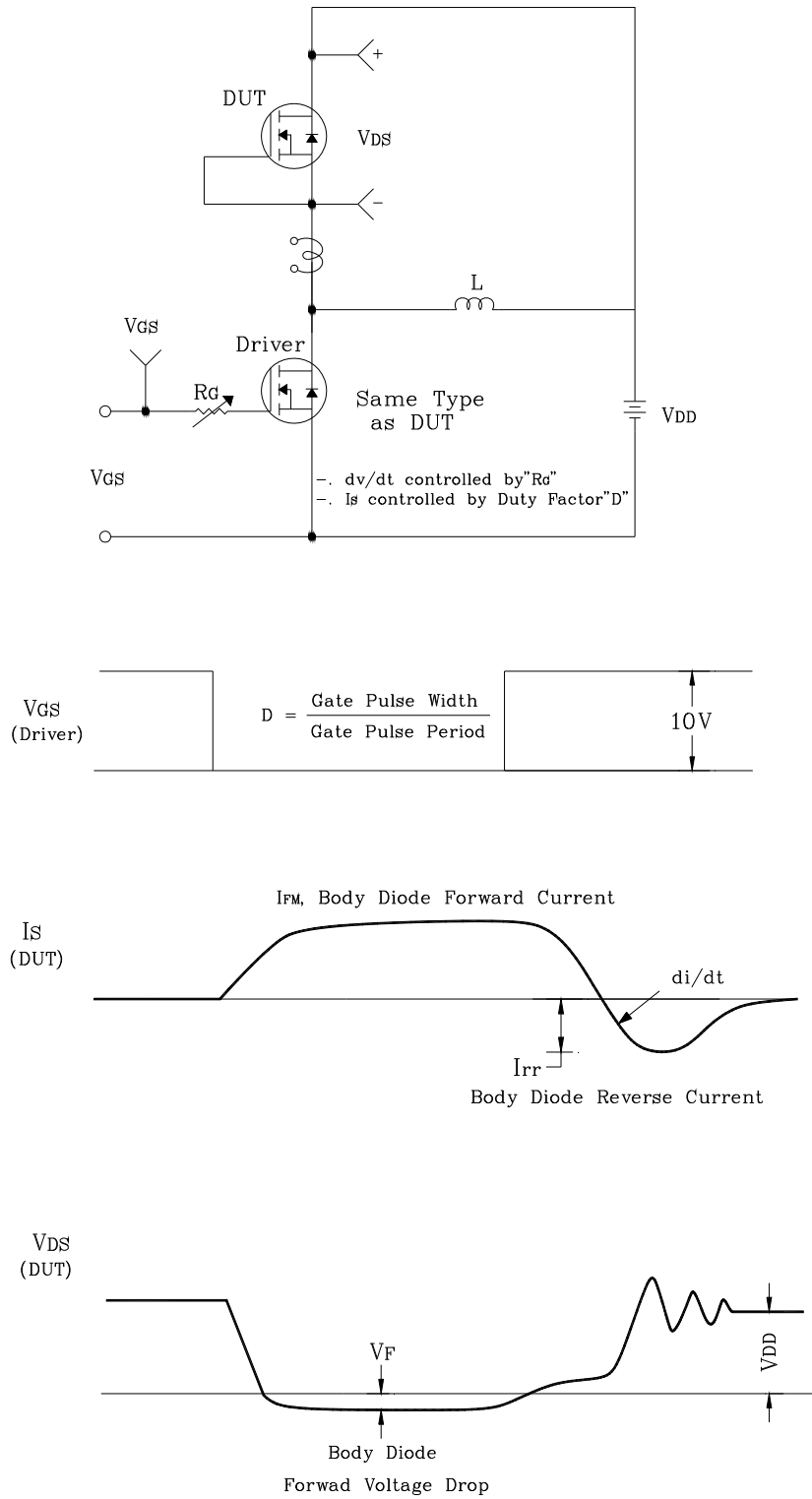
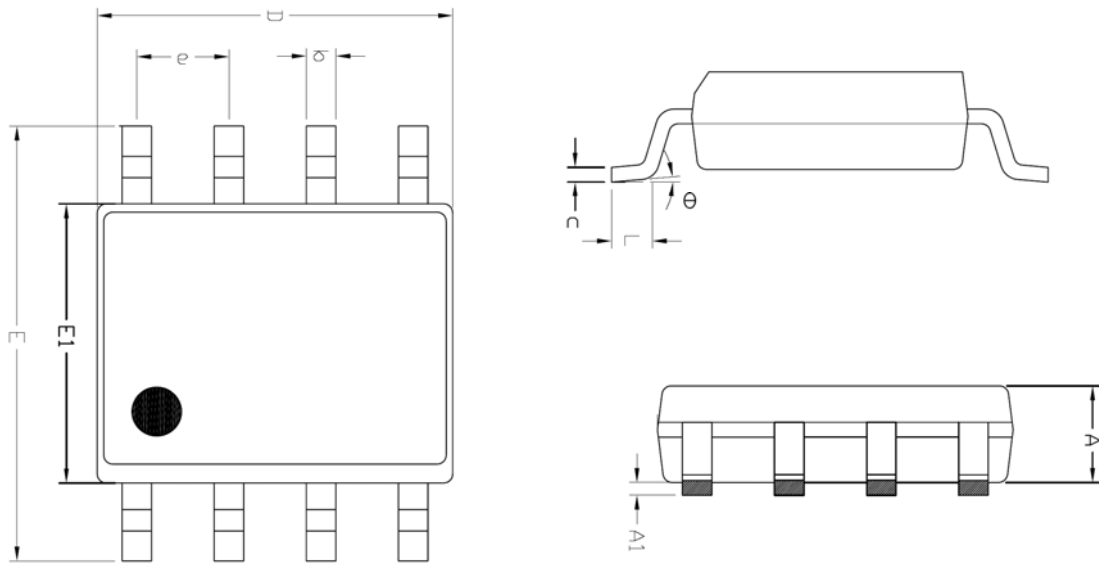

Fig. 14 Diode Reverse Recovery Time Test Circuit & Waveform



Package Outline Dimensions



SYMBOL	MILLIMETER(mm)			NOTE
	MINIMUM	NOMINAL	MAXIMUM	
A	1.245	—	1.445	
A1	0.125	0.175	0.275	
b	0.320	0.420	0.520	
c	0.170	0.220	0.270	
D	4.802	4.902	5.002	
E	5.870	6.020	6.170	
E1	3.761	3.861	3.961	
e	1.270 BSC			
L	0.462	0.562	0.662	
theta	0 °	—	8 °	

※ Recommended Land Pattern [unit: mm]

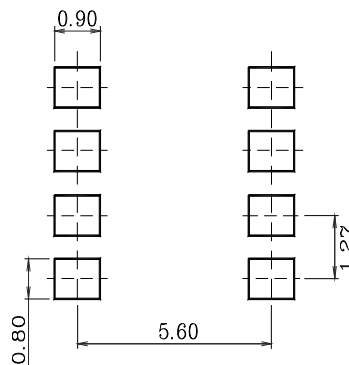

The AUK Corp. products are intended for the use as components in general electronic equipment (Office and communication equipment, measuring equipment, home appliance, etc.).

Please make sure that you consult with us before you use these AUK Corp. products in equipments which require high quality and / or reliability, and in equipments which could have major impact to the welfare of human life(atomic energy control, airplane, spaceship, transportation, combustion control, all types of safety device, etc.). AUK Corp. cannot accept liability to any damage which may occur in case these AUK Corp. products were used in the mentioned equipments without prior consultation with AUK Corp..

Specifications mentioned in this publication are subject to change without notice.