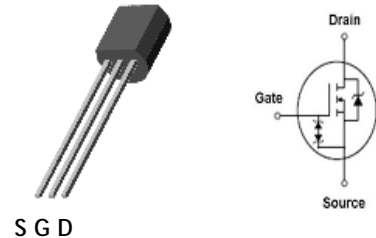

High Speed Switching Application

Features

- ESD rating: 1000V (HBM)
- Low On-Resistance: $R_{DS(on)} < 3\Omega$ @ $V_{GS} = 10V$
- High power and current handling capability
- Very fast switching
- Halogen free and RoHS compliant device

TO-92

Applications

- High speed line driver

Ordering Information

Part Number	Marking Code	Package	Packaging
2N7000K	2N7000K	TO-92	Tape

Marking Information

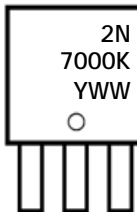

Column 1,2 : Device Code
 Column 3 : Production Information
 e.g.) YWW
 -. YWW : Date Code(year, week)

Absolute Maximum Ratings ($T_{amb}=25^{\circ}C$, Unless otherwise specified)

Characteristic	Symbol	Ratings	Unit
Drain-Source voltage	V_{DS}	60	V
Gate-Source voltage	V_{GS}	± 20	V
Maximum drain current ^(Note 1)	I_D	500	mA
Pulsed drain current ^(Note 1)	I_{DP}	2	A
Power dissipation ^(Note 2)	P_D	625	mW
Operating junction temperature	T_j	150	$^{\circ}C$
Storage temperature range	T_{stg}	-55 ~ 150	$^{\circ}C$
Thermal resistance junction to ambient ^(Note 2)	$R_{th(j-a)}$	400	$^{\circ}C/W$

Note 1) Limited only maximum junction temperature

Note 2) Device mounted on FR-4 board with recommended pad layout.

Electrical Characteristics (T_{amb}=25°C, Unless otherwise specified)

Characteristic	Symbol	Test Condition	Min.	Typ.	Max.	Unit
Drain-Source breakdown voltage	BV _{DSS}	I _D =250μA, V _{GS} =0	60	-	-	V
Gate-Source breakdown voltage	BV _{GSS}	I _G =250μA, V _{DS} =0	±20	-	-	V
Gate-Threshold voltage	V _{GS(th)}	I _D =250μA, V _{DS} =V _{GS}	1	-	2.5	V
Zero Gate voltage drain current	I _{DSS}	V _{DS} =60V, V _{GS} =0	-	-	1	μA
Gate-body leakage	I _{GSS}	V _{GS} =±20V, V _{DS} =0V	-	-	±10	μA
Drain-Source on-resistance (Note 3)	R _{DS(ON)}	V _{GS} =10V, I _D =0.5A	-	-	3	Ω
		V _{GS} =5V, I _D =0.05A	-	-	3.5	
Forward trans-conductance (Note 3)	g _{fs}	V _{DS} =10V, I _D =0.2A	0.08	-	-	S
Input capacitance	C _{iss}	V _{DS} =25V, V _{GS} =0, f=1MHz	-	30	50	pF
Output capacitance	C _{oss}		-	7	-	
Reverse Transfer capacitance	C _{rss}		-	4	-	
Turn-on delay time (Note 3, 4)	t _{d(on)}	V _{DD} =30V, I _D =0.2A, V _{GS} =10V, R _G =10Ω	-	2	-	ns
Rise time (Note 3, 4)	t _r		-	15	-	
Turn-off delay time (Note 3, 4)	t _{d(off)}		-	8	-	
Fall time (Note 3, 4)	t _f		-	11	-	
Total gate charge (Note 3, 4)	Q _g	V _{DS} =10V, I _D =0.25A, V _{GS} =4.5V	-	0.6	0.8	nC
Gate-Source charge (Note 3, 4)	Q _{gs}		-	0.2	-	
Gate-Drain charge (Note 3, 4)	Q _{gd}		-	0.2	-	
Diode forward voltage (Note 3)	V _{SD}	V _{GS} =0V, I _S =0.2A	-	-	1.3	V

Note 3) Pulse test: Pulse width ≤ 300μs, Duty cycle ≤ 2%

Note 4) Essentially independent of operating temperature typical characteristics.

Electrical Characteristics Curves

Fig. 1 $I_D - V_{DS}$

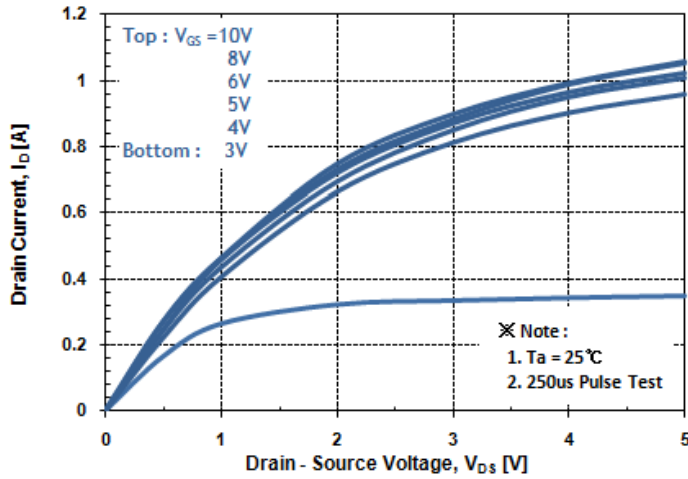

Fig. 2 $I_D - V_{GS}$

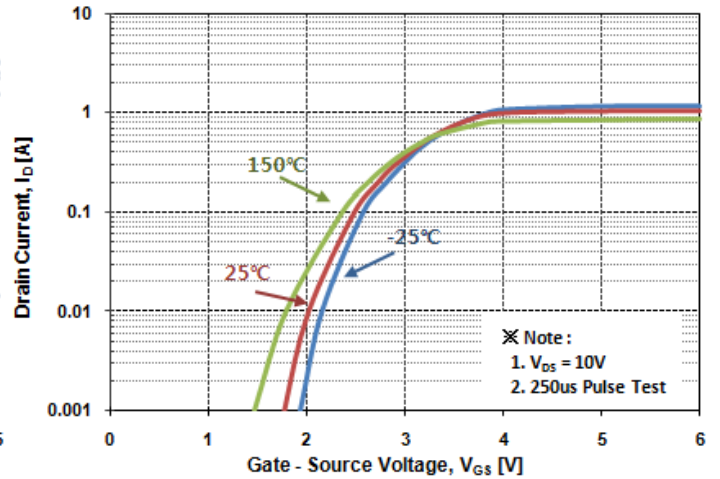

Fig. 3 $R_{DS(ON)} - I_D$

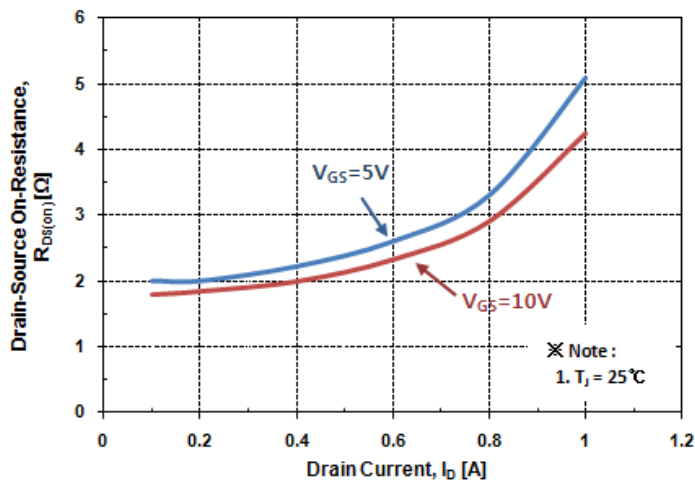

Fig. 4 $I_S - V_{SD}$

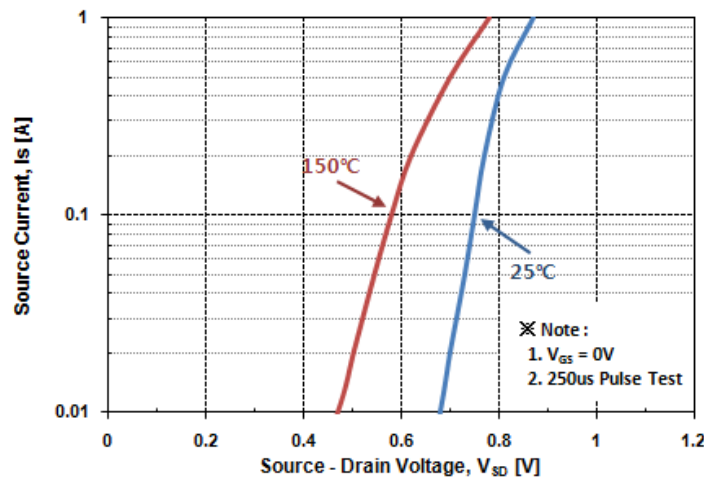

Fig. 5 Capacitance - V_{DS}

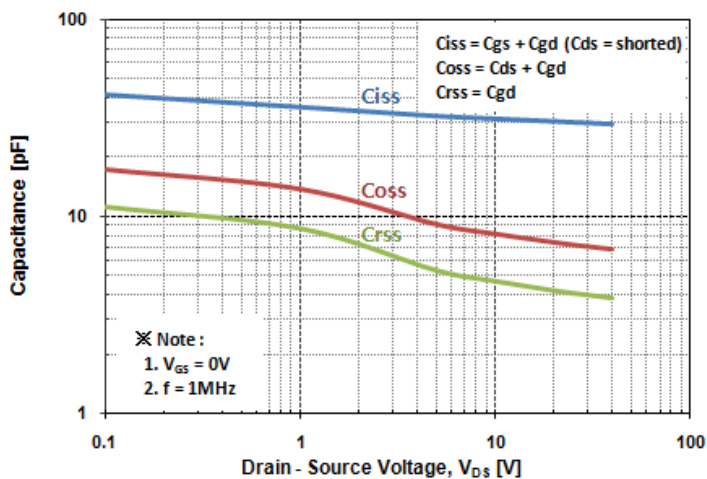

Fig. 6 $V_{GS} - Q_G$

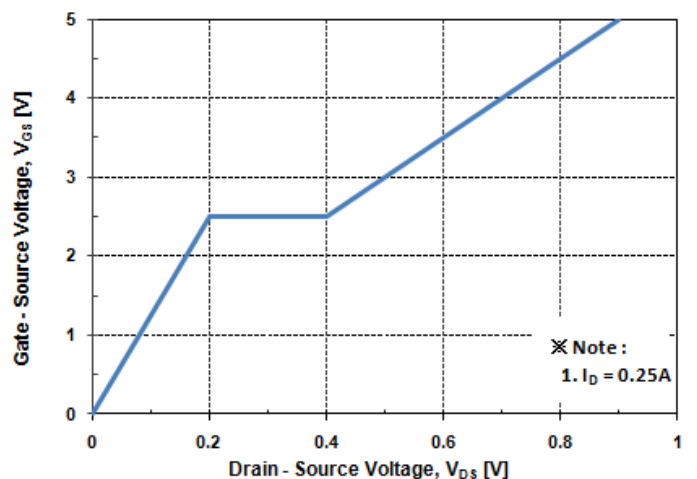

Fig. 7 $V_{DSS} - T_J$

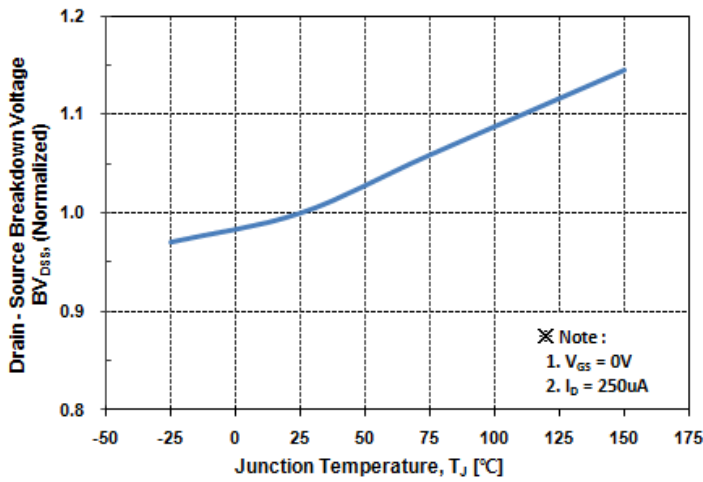

Fig. 8 $R_{DS(on)} - T_J$

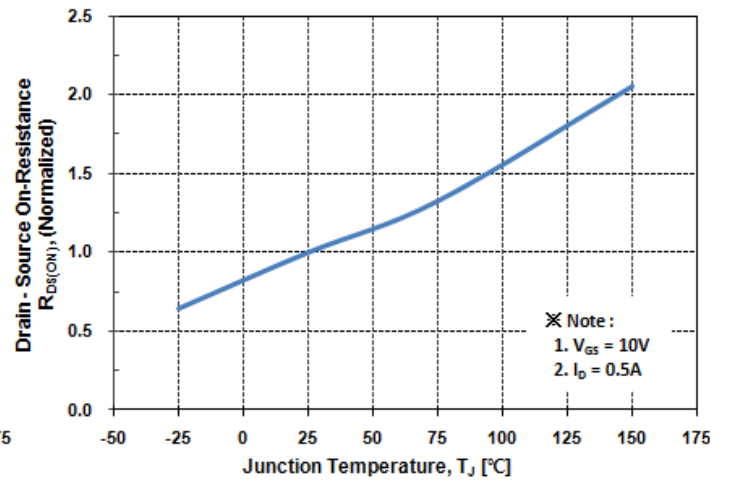

Fig. 9 $I_D - T_C$

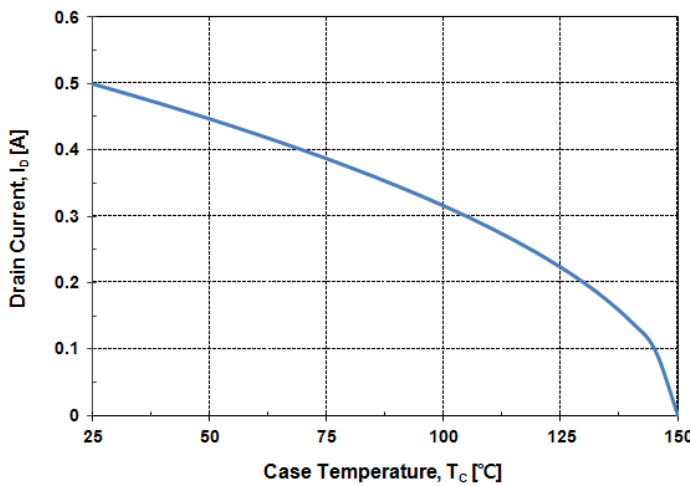
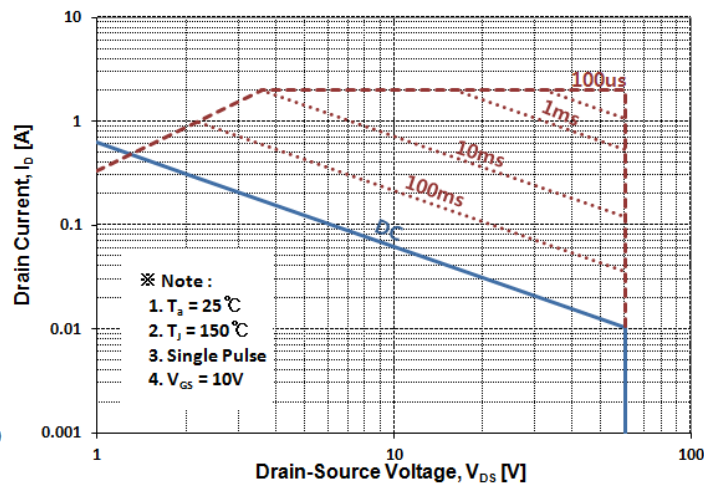
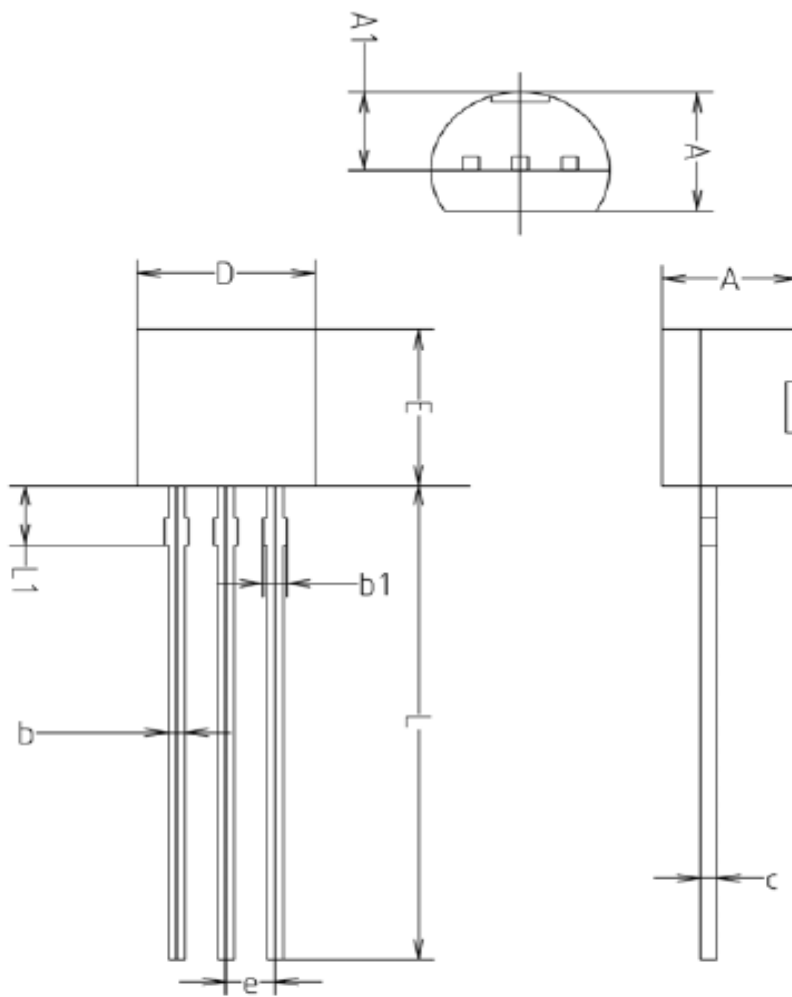

Fig. 10 Safe Operating Area



Package Outline Dimensions



SYMBOL	MILLIMETERS(mm)		
	MINIMUM	NOMINAL	MAXIMUM
A	3.40	3.50	3.66
A1	2.46	2.51	2.59
b	0.39	0.44	0.53
b1	0.39	—	0.63
c	0.35	0.42	0.47
D	4.48	4.60	4.70
E	4.48	4.60	4.70
e	1.17	1.27	1.37
L	13.70	14.00	14.77
L1	1.55	1.70	2.15

The AUK Corp. products are intended for the use as components in general electronic equipment (Office and communication equipment, measuring equipment, home appliance, etc.).

Please make sure that you consult with us before you use these AUK Corp. products in equipments which require high quality and / or reliability, and in equipments which could have major impact to the welfare of human life(atomic energy control, airplane, spaceship, transportation, combustion control, all types of safety device, etc.). AUK Corp. cannot accept liability to any damage which may occur in case these AUK Corp. products were used in the mentioned equipments without prior consultation with AUK Corp..

Specifications mentioned in this publication are subject to change without notice.