

SWITCHING REGULATOR APPLICATION

Features

- Drain-Source breakdown voltage: $BV_{DSS}=700V$ (Min.)
- Low gate charge: $Q_g=13nC$ (Typ.)
- Low drain-source On resistance: $R_{DS(on)}=2.36\Omega$ (Max.)
- 100% avalanche tested
- RoHS compliant device

Ordering Information

| Part Number | Marking | Package |
|-------------|---------|------------|
| SMN0470F | SMN0470 | TO-220F-3L |

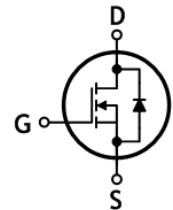

TO-220F-3L

Marking Information

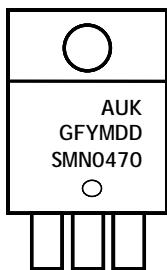

Column 1: Manufacturer
 Column 2: Production Information
 e.g.) GFYMDD
 -. G: Option Code (H: Halogen Free)
 -. F: Factory Management Code
 -. YMDD: Date Code (Year, Month, Date)
 Column 3: Device Code

Absolute maximum ratings ($T_C=25^\circ C$ unless otherwise noted)

| Characteristic | Symbol | Rating | Unit | |
|--|-----------|-------------------|------------|---|
| Drain-source voltage | V_{DSS} | 700 | V | |
| Gate-source voltage | V_{GSS} | ± 30 | V | |
| Drain current (DC) * | I_D | $T_C=25^\circ C$ | 4 | A |
| | | $T_C=100^\circ C$ | 2.53 | A |
| Drain current (Pulsed) * | I_{DM} | 16 | A | |
| Single avalanche current ^(Note 2) | I_{AS} | 4 | A | |
| Single pulsed avalanche energy ^(Note 2) | E_{AS} | 344 | mJ | |
| Repetitive avalanche current ^(Note 1) | I_{AR} | 4 | A | |
| Repetitive avalanche energy ^(Note 1) | E_{AR} | 2.9 | mJ | |
| Power dissipation | P_D | 29 | W | |
| Junction temperature | T_J | 150 | $^\circ C$ | |
| Storage temperature range | T_{stg} | -55-150 | $^\circ C$ | |

* Limited only maximum junction temperature

Thermal Characteristics

| Characteristic | Symbol | Rating | Unit |
|---|---------------|-----------|------|
| Thermal resistance, junction to case | $R_{th(j-c)}$ | Max. 4.27 | °C/W |
| Thermal resistance, junction to ambient | $R_{th(j-a)}$ | Max. 62.5 | |

Electrical Characteristics ($T_C=25^\circ\text{C}$ unless otherwise noted)

| Characteristic | Symbol | Test Condition | Min. | Typ. | Max. | Unit |
|---------------------------------------|--------------|---|------|------|-----------|---------------|
| Drain-source breakdown voltage | BV_{DSS} | $I_D=250\mu\text{A}$, $V_{GS}=0$ | 700 | - | - | V |
| Gate threshold voltage | $V_{GS(th)}$ | $I_D=250\mu\text{A}$, $V_{DS}=V_{GS}$ | 3 | 4 | 5 | V |
| Drain-source cut-off current | I_{DSS} | $V_{DS}=700\text{V}$, $V_{GS}=0\text{V}$ | - | - | 1 | μA |
| Gate leakage current | I_{GSS} | $V_{DS}=0\text{V}$, $V_{GS}=\pm 30\text{V}$ | - | - | ± 100 | nA |
| Drain-source on-resistance | $R_{DS(on)}$ | $V_{GS}=10\text{V}$, $I_D=2\text{A}$ | - | 2 | 2.36 | Ω |
| Forward transfer conductance (Note 3) | g_{fs} | $V_{DS}=10\text{V}$, $I_D=2\text{A}$ | - | 4 | - | S |
| Input capacitance | C_{iss} | $V_{DS}=25\text{V}$, $V_{GS}=0\text{V}$, $f=1.0\text{MHz}$ | - | 736 | 1046 | pF |
| Output capacitance | C_{oss} | | - | 65 | 92 | |
| Reverse transfer capacitance | C_{rss} | | - | 8.2 | 12 | |
| Turn-on delay time (Note 3,4) | $t_{d(on)}$ | $V_{DD}=350\text{V}$, $I_D=4\text{A}$, $R_G=25\Omega$ | - | 60 | 139 | ns |
| Rise time (Note 3,4) | t_r | | - | 73 | 161 | |
| Turn-off delay time (Note 3,4) | $t_{d(off)}$ | | - | 98 | 216 | |
| Fall time (Note 3,4) | t_f | | - | 32 | 73 | |
| Total gate charge (Note 3,4) | Q_g | $V_{DS}=560\text{V}$, $V_{GS}=10\text{V}$, $I_D=4\text{A}$ | - | 13 | 18 | nC |
| Gate-source charge (Note 3,4) | Q_{gs} | | - | 5 | - | |
| Gate-drain charge (Note 3,4) | Q_{gd} | | - | 3 | - | |

Source-Drain Diode Ratings and Characteristics ($T_C=25^\circ\text{C}$ unless otherwise noted)

| Characteristic | Symbol | Test Condition | Min. | Typ. | Max. | Unit |
|------------------------------------|----------|---|------|------|------|---------------|
| Source current (DC) | I_S | Integral reverse diode in the MOSFET | - | - | 4 | A |
| Source current (Pulsed) | I_{SM} | | - | - | 16 | A |
| Forward voltage | V_{SD} | $V_{GS}=0\text{V}$, $I_S=4\text{A}$ | - | - | 1.4 | V |
| Reverse recovery time (Note 3,4) | t_{rr} | $I_S=4\text{A}$, $V_{GS}=0\text{V}$ $di_F/dt=100\text{A}/\mu\text{s}$ | - | 481 | - | ns |
| Reverse recovery charge (Note 3,4) | Q_{rr} | | - | 2.1 | - | μC |

Note:

1. Repeated rating: Pulse width limited by safe operating area
2. $L=40\text{mH}$, $I_{AS}=4\text{A}$, $V_{DD}=50\text{V}$, $R_G=25\Omega$, Starting $T_J=25^\circ\text{C}$
3. Pulse test: Pulse width $\leq 300\mu\text{s}$, Duty cycle $\leq 2\%$
4. Essentially independent of operating temperature typical characteristics

Electrical Characteristics Curves

Fig. 1 $I_D - V_{DS}$

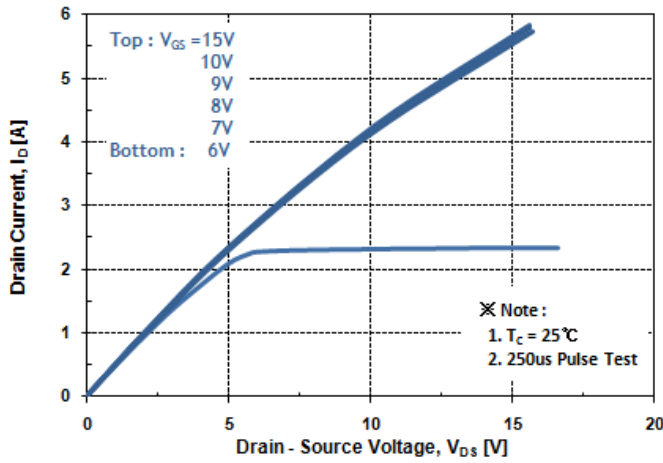

Fig. 2 $I_D - V_{GS}$

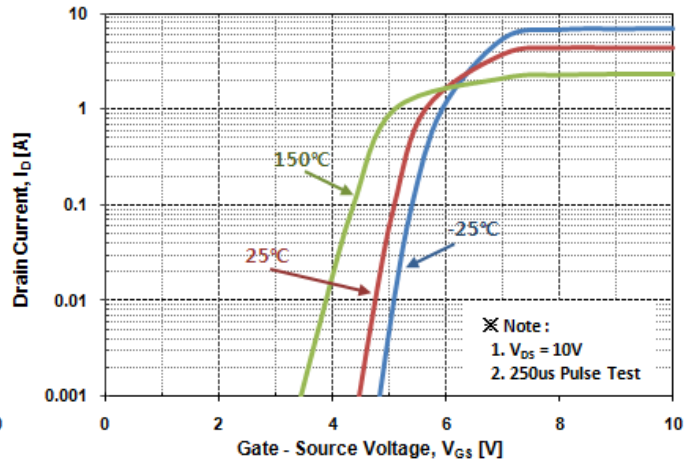

Fig. 3 $R_{DS(ON)} - I_D$

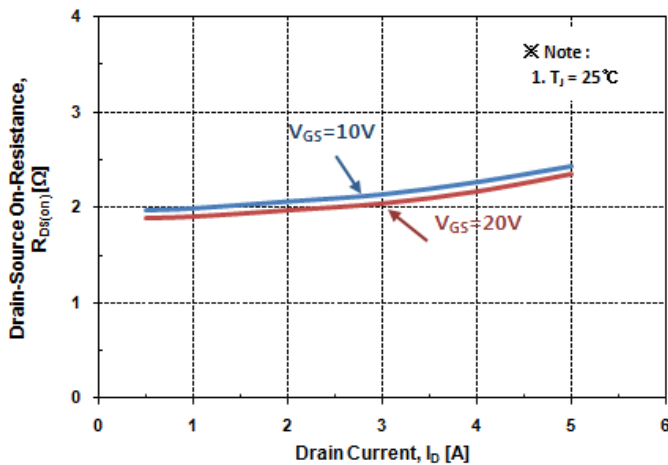

Fig. 4 $I_S - V_{SD}$

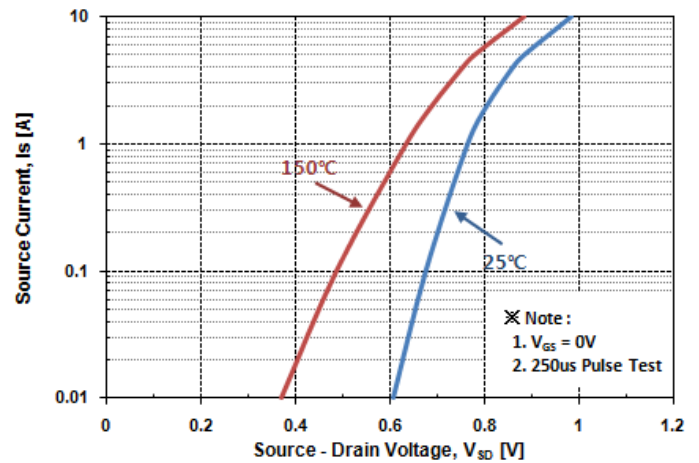

Fig. 5 Capacitance - V_{DS}

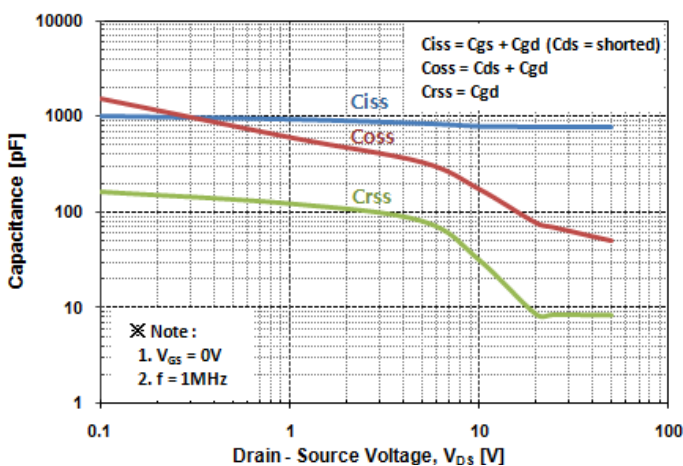

Fig. 6 $V_{GS} - Q_G$

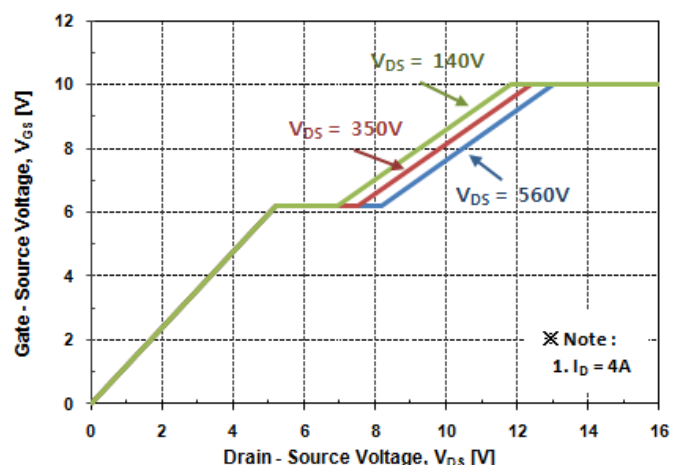

Fig. 7 $V_{DSS} - T_J$

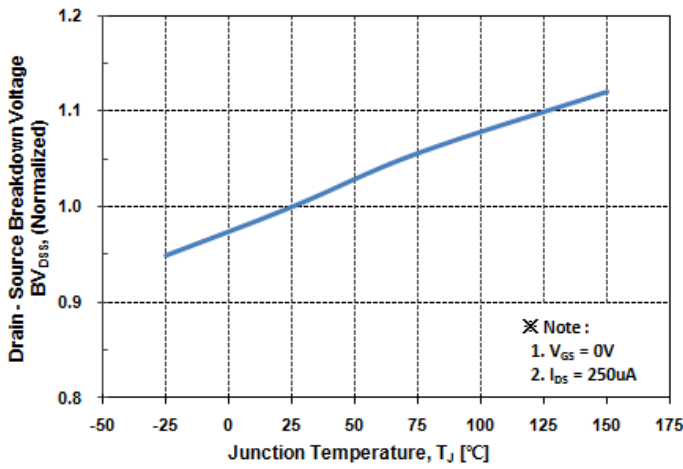

Fig. 8 $R_{DS(on)} - T_J$

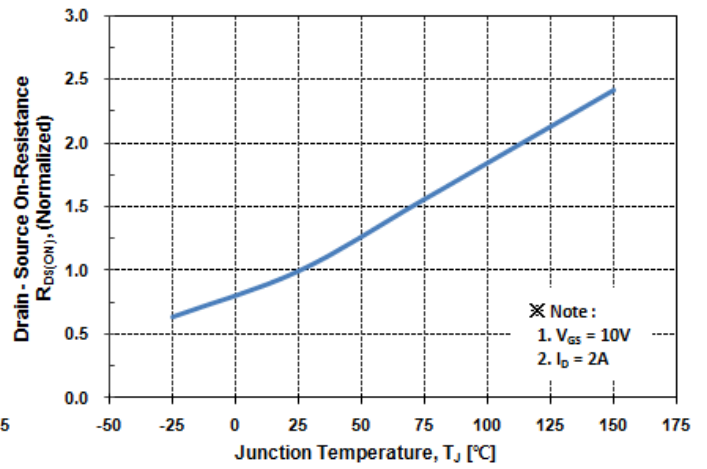

Fig. 9 $I_D - T_C$

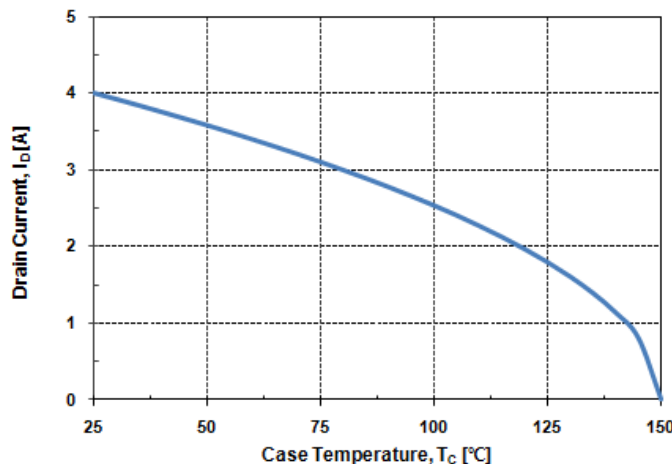

Fig. 10 Safe Operating Area

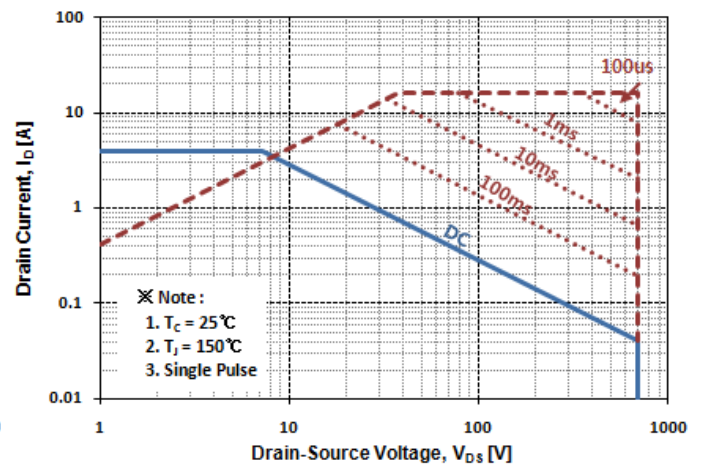

Fig. 11 Transient Thermal Impedance

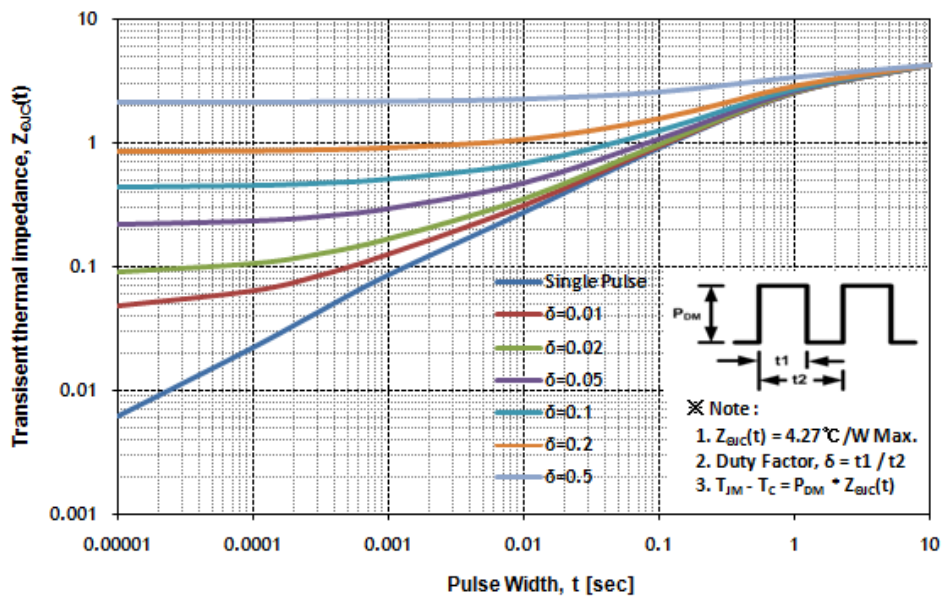

Fig. 12 Gate Charge Test Circuit & Waveform

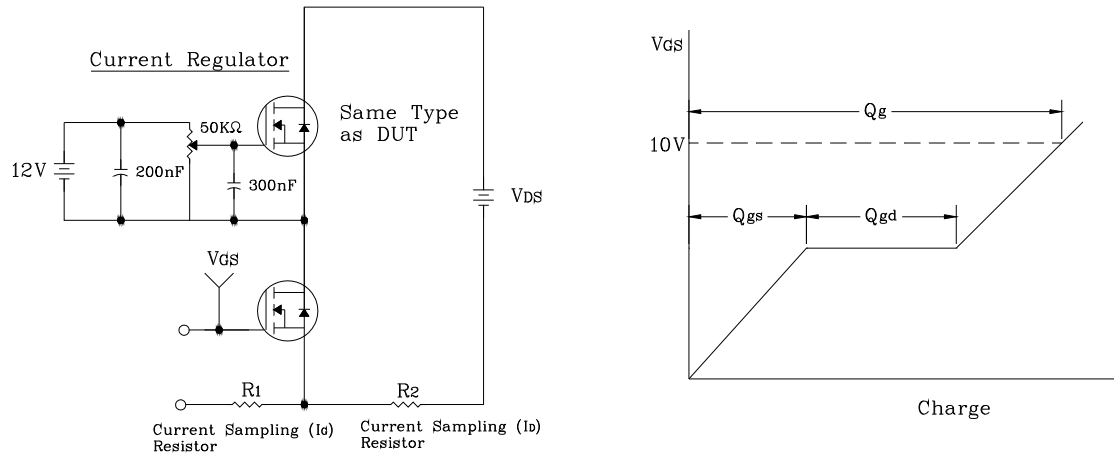

Fig. 13 Resistive Switching Test Circuit & Waveform

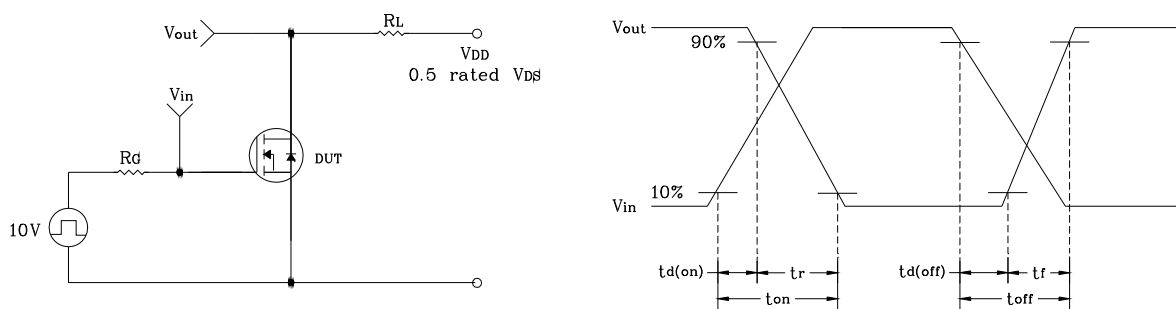

Fig. 14 E_{AS} Test Circuit & Waveform

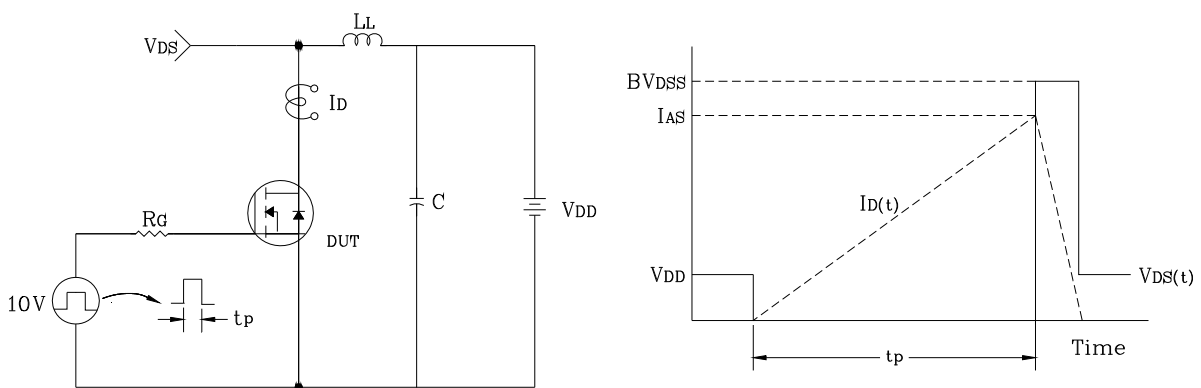
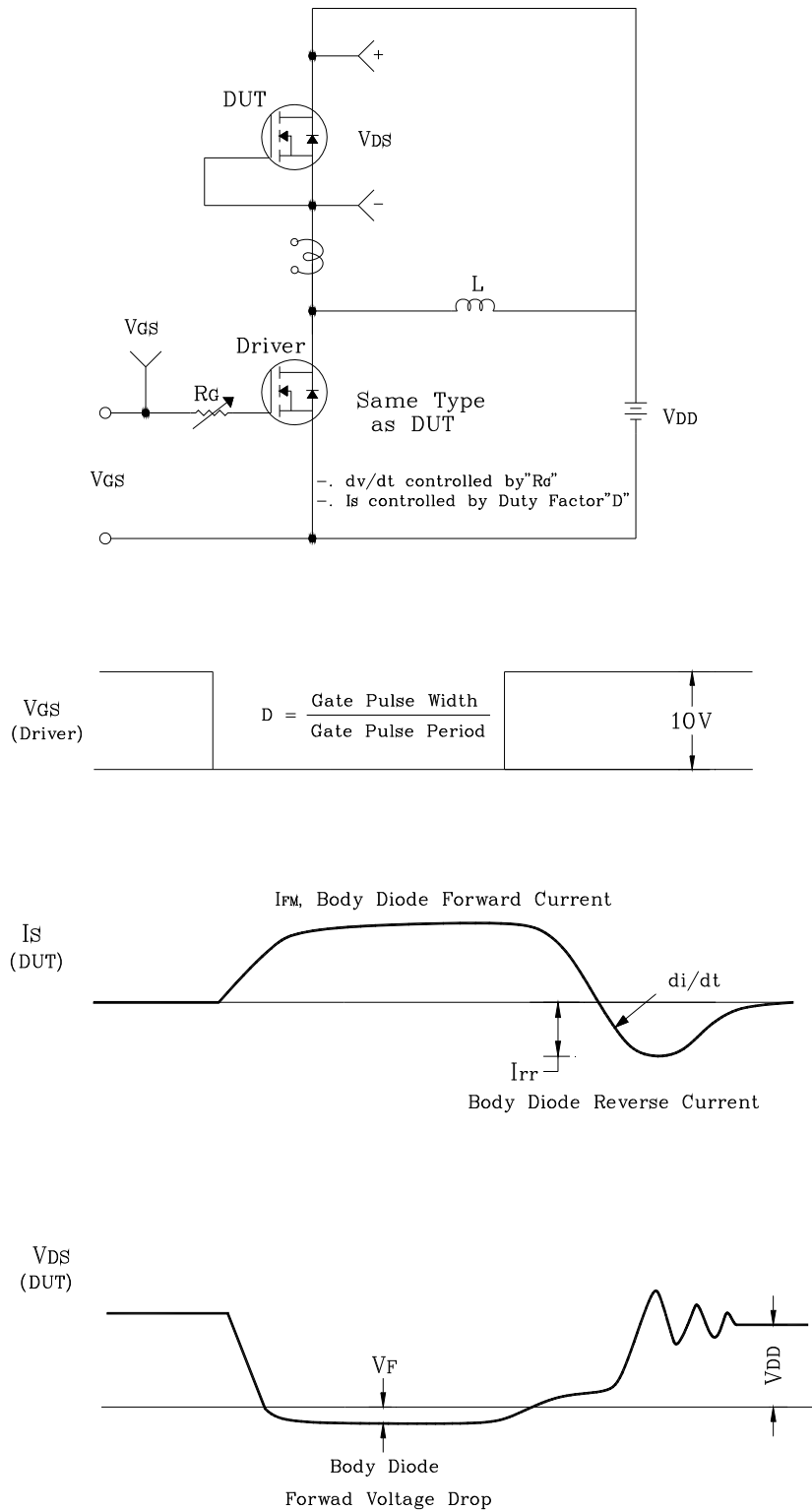
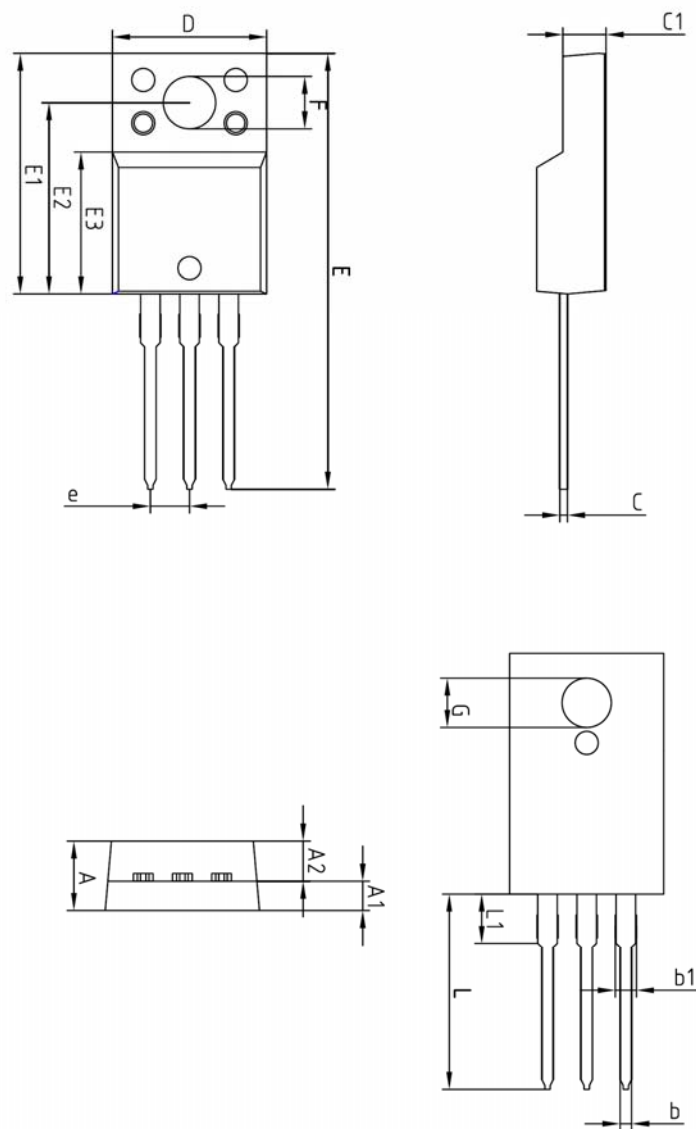

Fig. 15 Diode Reverse Recovery Time Test Circuit & Waveform



Package Outline Dimensions



| SYMBOL | MILLIMETERS | | | NOTE |
|--------|-------------|---------|---------|------|
| | MINIMUM | NOMINAL | MAXIMUM | |
| A | - | - | 4.60 | |
| A1 | 2.45 | 2.50 | 2.55 | |
| A2 | 1.95 | 2.00 | 2.05 | |
| b | 0.65 | 0.75 | 0.85 | |
| b1 | 1.07 | 1.27 | 1.47 | |
| C | 0.40 | 0.50 | 0.60 | |
| C1 | 2.70 | 2.80 | 2.90 | |
| D | 9.90 | 10.00 | 10.10 | |
| E | 28.00 | - | 28.60 | |
| E1 | 15.50 | 15.60 | 15.70 | |
| E2 | 12.30 | 12.40 | 12.50 | |
| E3 | 9.15 | 9.20 | 9.25 | |
| F | 3.30 | 3.40 | 3.50 | |
| G | 3.10 | 3.20 | 3.30 | |
| e | 2.54 BSC | | | |
| L | 12.40 | - | 13.00 | |
| L1 | 3.46 BSC | | | |

The AUK Corp. products are intended for the use as components in general electronic equipment (Office and communication equipment, measuring equipment, home appliance, etc.).

Please make sure that you consult with us before you use these AUK Corp. products in equipments which require high quality and / or reliability, and in equipments which could have major impact to the welfare of human life(atomic energy control, airplane, spaceship, transportation, combustion control, all types of safety device, etc.). AUK Corp. cannot accept liability to any damage which may occur in case these AUK Corp. products were used in the mentioned equipments without prior consultation with AUK Corp..

Specifications mentioned in this publication are subject to change without notice.