

200V LOGIC N-Channel MOSFET

Features

- 0.85A, 200V, $R_{DS(on)}=1.35\Omega$ @ $V_{GS}=10V$
- Low gate charge: $Q_g=4nC$ (Typ.)
- Fast switching
- 100% avalanche tested
- RoHS compliant device

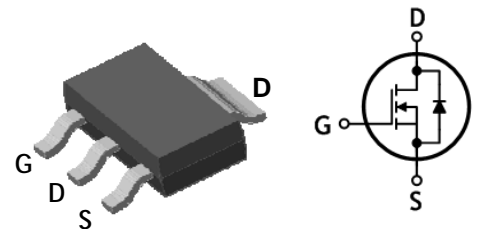

Ordering Information

Part Number	Marking	Package
SMN01L20Q	SMN01L20	SOT-223

SOT-223

Marking Information

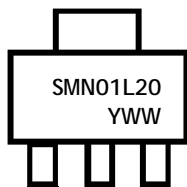

Column 1: Device Code
 Column 2: Production Information
 e.g.) YWW
 -. Y: Year Code
 -. WW: Week Code

Absolute maximum ratings ($T_c=25^\circ C$ unless otherwise noted)

Characteristic	Symbol	Rating	Unit	
Drain-source voltage	V_{DSS}	200	V	
Gate-source voltage	V_{GSS}	± 20	V	
Drain current (DC) *	I_D	$T_c=25^\circ C$	0.85	A
		$T_c=70^\circ C$	0.68	A
Drain current (Pulsed) *	I_{DM}	3.4	A	
Single avalanche current ^(Note 2)	I_{AS}	0.85	A	
Single pulsed avalanche energy ^(Note 2)	E_{AS}	52	mJ	
Repetitive avalanche current ^(Note 1)	I_{AR}	0.85	A	
Repetitive avalanche energy ^(Note 1)	E_{AR}	0.2	mJ	
Power dissipation	P_D	2	W	
Junction temperature	T_J	150	$^\circ C$	
Storage temperature range	T_{stg}	-55-150	$^\circ C$	

* Limited only maximum junction temperature

Thermal Characteristics

Characteristic	Symbol	Rating	Unit
Thermal resistance, junction to ambient	$R_{th(j-a)}$	Max. 62.5	°C/W

Electrical Characteristics ($T_C=25^\circ\text{C}$ unless otherwise noted)

Characteristic	Symbol	Test Condition	Min.	Typ.	Max.	Unit
Drain-source breakdown voltage	BV_{DSS}	$I_D=250\mu\text{A}$, $V_{GS}=0$	200	-	-	V
Gate threshold voltage	$V_{GS(th)}$	$I_D=250\mu\text{A}$, $V_{DS}=V_{GS}$	1	1.75	2.25	V
Drain-source cut-off current	I_{DSS}	$V_{DS}=200\text{V}$, $V_{GS}=0\text{V}$	-	-	1	uA
		$V_{DS}=160\text{V}$, $T_C=25^\circ\text{C}$	-	-	10	
Gate leakage current	I_{GSS}	$V_{DS}=0\text{V}$, $V_{GS}=\pm 20\text{V}$	-	-	± 100	nA
Drain-source on-resistance	$R_{DS(ON)}$	$V_{GS}=10\text{V}$, $I_D=0.425\text{A}$	-	1.1	1.35	Ω
		$V_{GS}=5\text{V}$, $I_D=0.425\text{A}$	-	1.13	1.4	Ω
Forward transfer conductance (Note 3)	g_{fs}	$V_{DS}=10\text{V}$, $I_D=0.425\text{A}$	-	1.42	-	S
Input capacitance	C_{iss}	$V_{DS}=25\text{V}$, $V_{GS}=0\text{V}$, $f=1\text{MHz}$	-	224	302	pF
Output capacitance	C_{oss}		-	38	51	
Reverse transfer capacitance	C_{rss}		-	6.2	10	
Turn-on delay time (Note 3,4)	$t_{d(on)}$	$V_{DD}=100\text{V}$, $I_D=3.2\text{A}$, $R_G=25\Omega$	-	23	51	ns
Rise time (Note 3,4)	t_r		-	85	177	
Turn-off delay time (Note 3,4)	$t_{d(off)}$		-	80	169	
Fall time (Note 3,4)	t_f		-	32	68	
Total gate charge (Note 3,4)	Q_g	$V_{DS}=160\text{V}$, $V_{GS}=5\text{V}$, $I_D=3.2\text{A}$	-	4	5	nC
Gate-source charge (Note 3,4)	Q_{gs}		-	1.4	-	
Gate-drain charge (Note 3,4)	Q_{gd}		-	0.6	-	

Source-Drain Diode Ratings and Characteristics ($T_C=25^\circ\text{C}$ unless otherwise noted)

Characteristic	Symbol	Test Condition	Min.	Typ.	Max.	Unit
Source current (DC)	I_S	Integral reverse diode in the MOSFET	-	-	0.85	A
Source current (Pulsed)	I_{SM}		-	-	3.4	A
Forward voltage	V_{SD}	$V_{GS}=0\text{V}$, $I_S=0.85\text{A}$	-	-	1.5	V
Reverse recovery time (Note 3,4)	t_{rr}	$I_S=3.2\text{A}$, $V_{GS}=0\text{V}$ $di_f/dt=100\text{A}/\mu\text{s}$	-	90	-	ns
Reverse recovery charge (Note 3,4)	Q_{rr}		-	0.29	-	uC

Note:

1. Repeated rating: Pulse width limited by safe operating area
2. $L=108\text{mH}$, $I_{AS}=0.85\text{A}$, $V_{DD}=50\text{V}$, $R_G=25\Omega$, Starting $T_J=25^\circ\text{C}$
3. Pulse test: Pulse width $\leq 300\mu\text{s}$, Duty cycles $\leq 2\%$
4. Essentially independent of operating temperature typical characteristics

Electrical Characteristics Curves

Fig. 1 $I_D - V_{DS}$

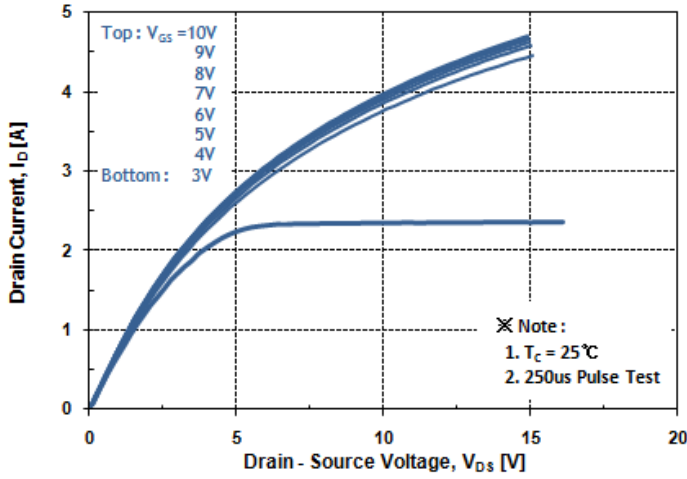

Fig. 2 $I_D - V_{GS}$

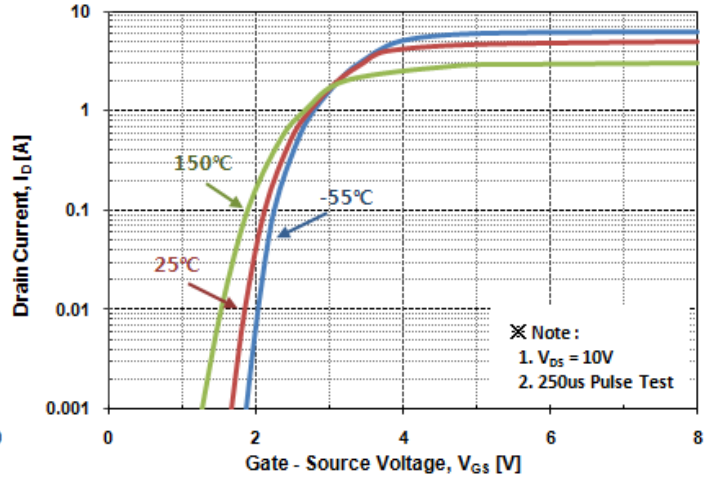

Fig. 3 $R_{DS(ON)} - I_D$

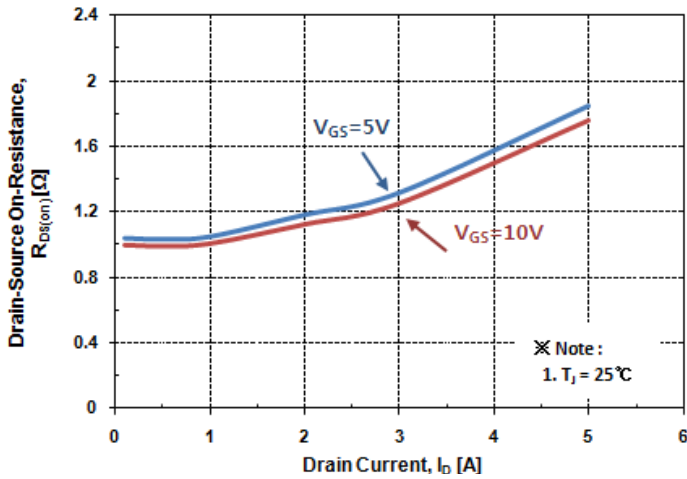

Fig. 4 $I_S - V_{SD}$

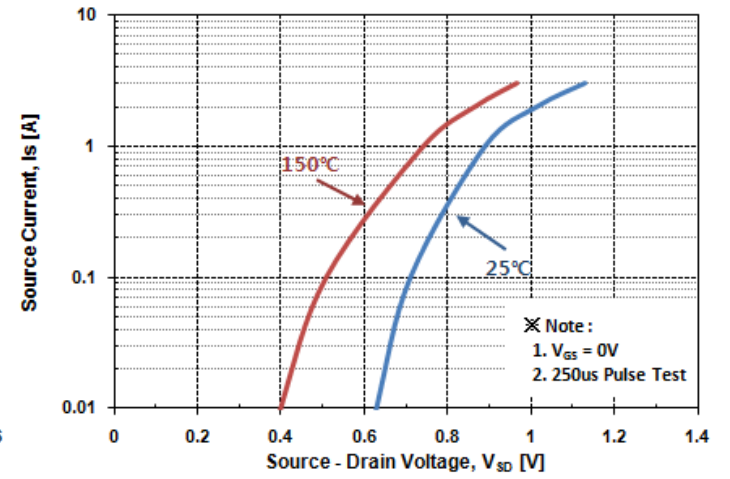

Fig. 5 Capacitance - V_{DS}

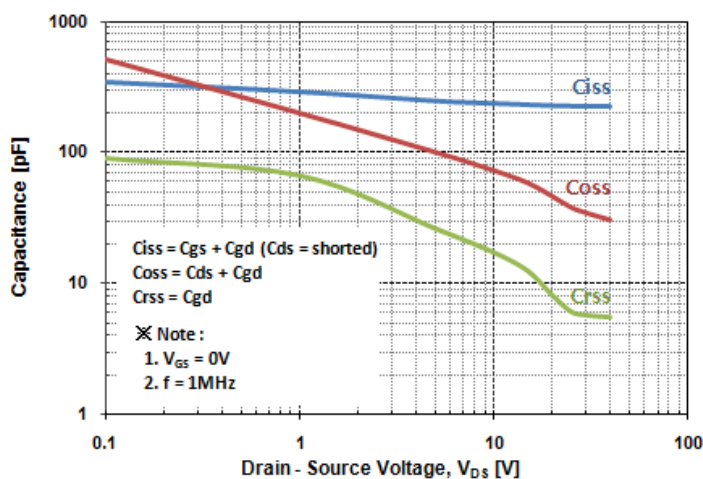

Fig. 6 $V_{GS} - Q_G$

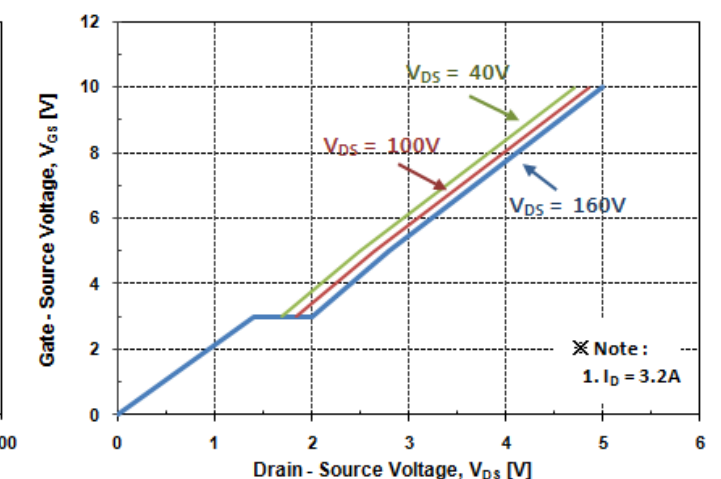

Fig. 7 $BV_{DSS} - T_J$

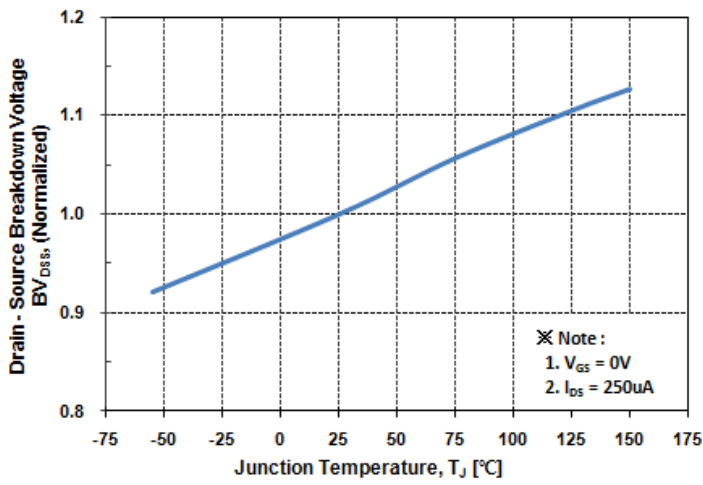

Fig. 8 $R_{DS(on)} - T_J$

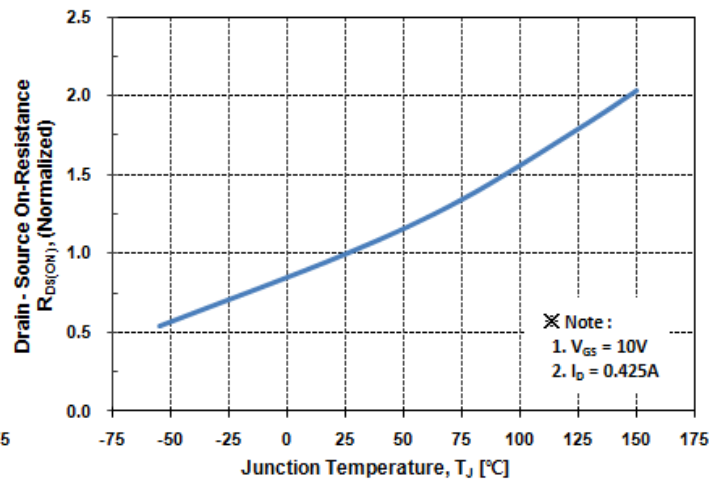

Fig. 9 $I_D - T_C$

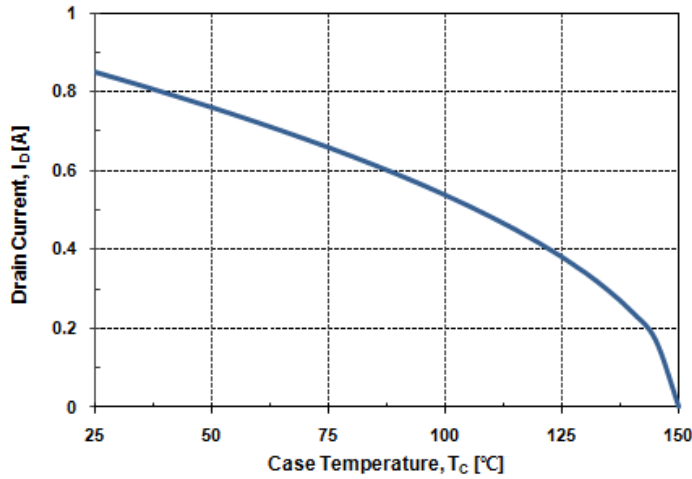

Fig. 10 Safe Operating Area

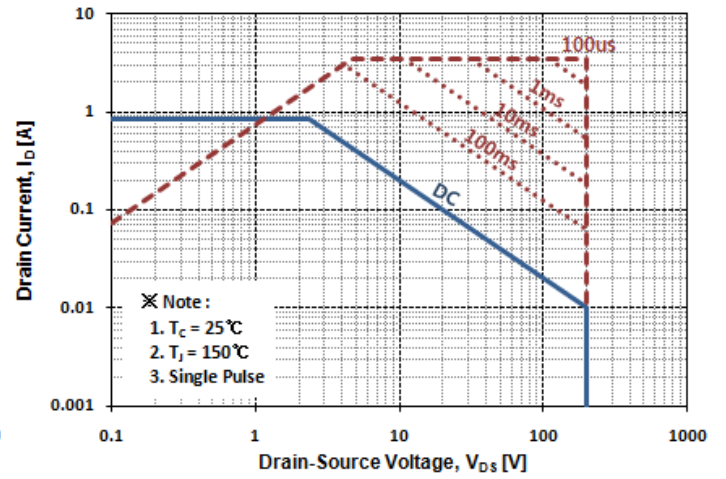

Fig. 11 Transient Thermal Impedance

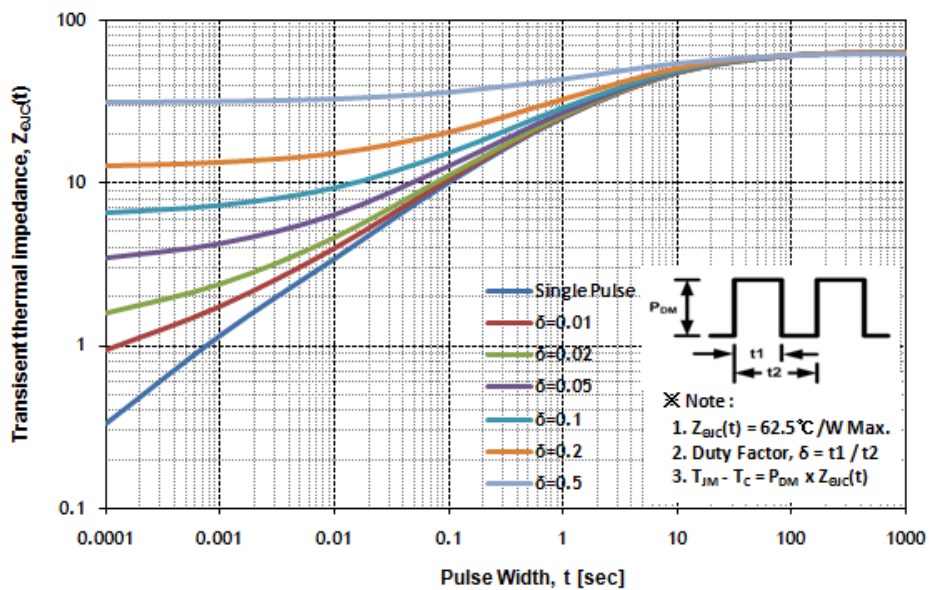

Fig. 12 Gate Charge Test Circuit & Waveform

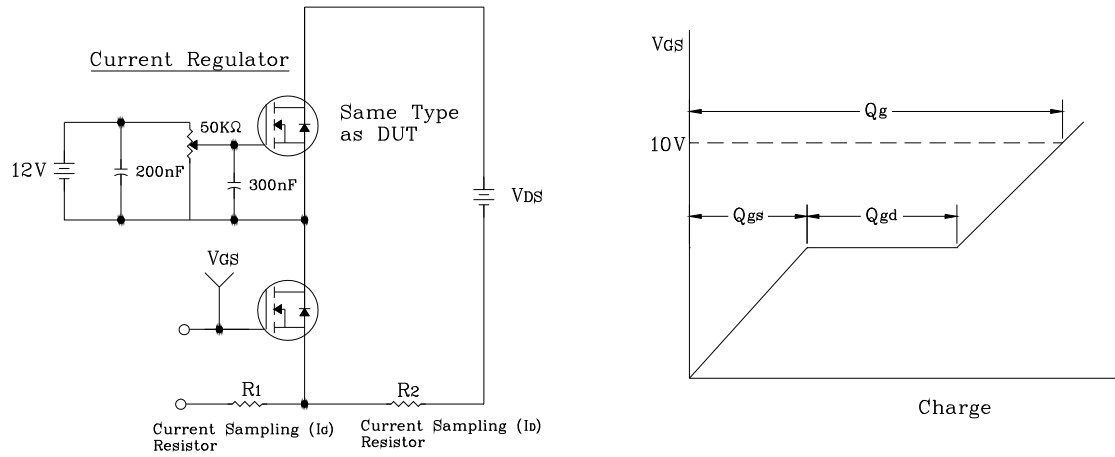

Fig. 13 Resistive Switching Test Circuit & Waveform

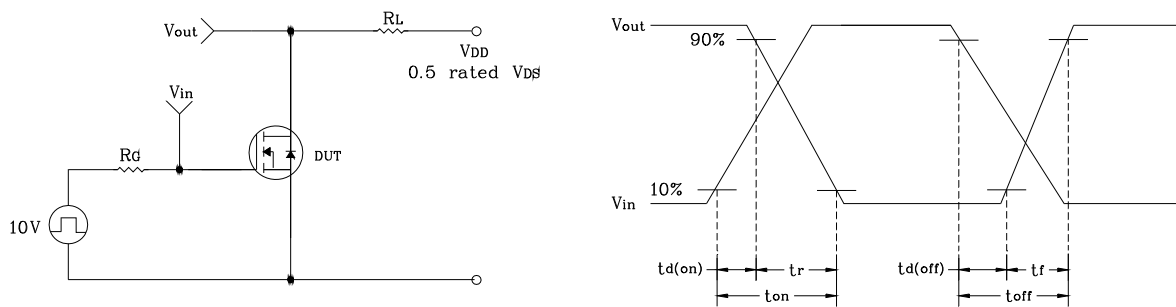

Fig. 14 E_{AS} Test Circuit & Waveform

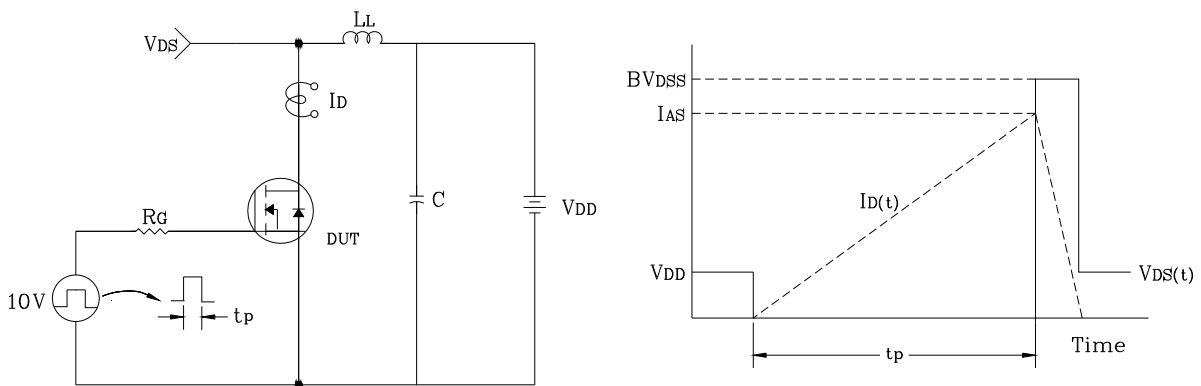
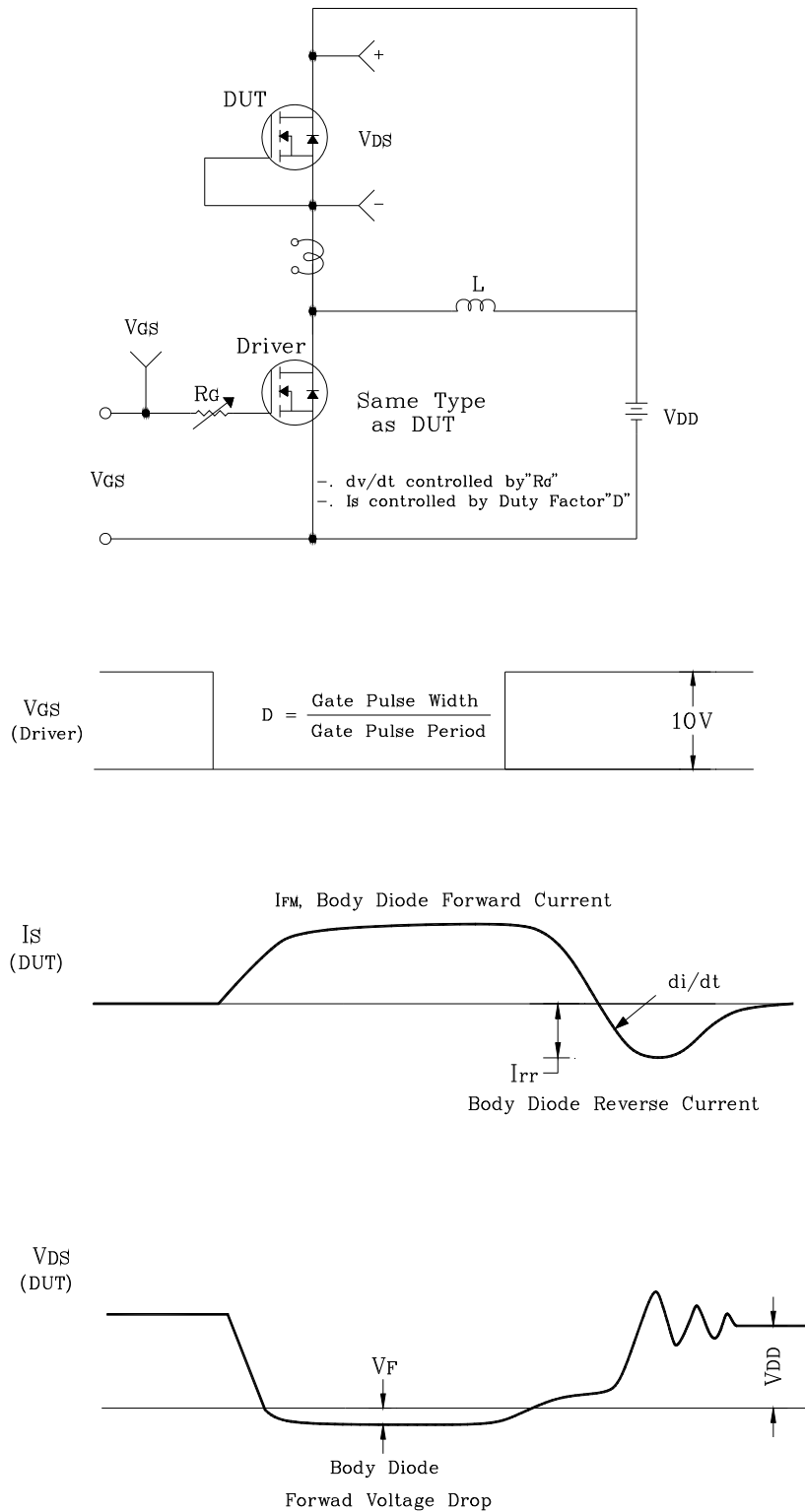
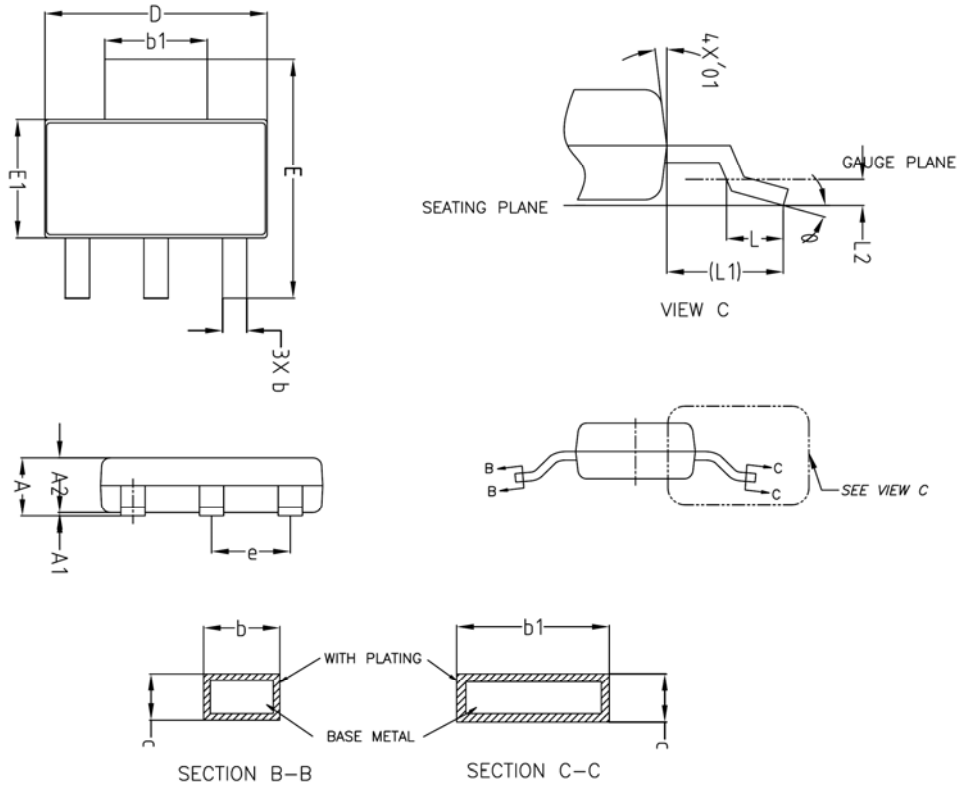

Fig. 15 Diode Reverse Recovery Time Test Circuit & Waveform



Package Outline Dimensions



SYMBOL	MILLIMETERS			NOTE
	MINIMUM	NOMINAL	MAXIMUM	
A	—	—	1.80	
A1	0.00	—	0.10	
A2	1.60	1.65	1.70	
b	0.68	—	0.76	
b1	2.95	—	3.07	
c	0.23	—	0.28	
D	6.40	6.50	6.60	
E	6.80	7.00	7.20	
E1	3.40	3.50	3.60	
e	2.30 BSC			
L	0.45	—	0.65	
L1	1.75 REF			
L2	0.10 BSC			
theta	0°	—	10°	
theta1	5°	—	10°	

※ Recommended Land Pattern (unit: mm)

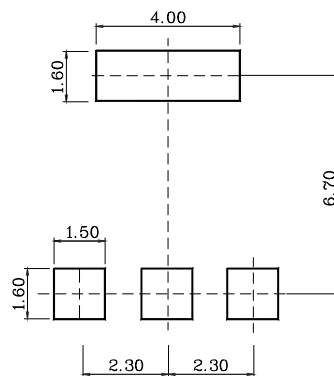

The AUK Corp. products are intended for the use as components in general electronic equipment (Office and communication equipment, measuring equipment, home appliance, etc.).

Please make sure that you consult with us before you use these AUK Corp. products in equipments which require high quality and / or reliability, and in equipments which could have major impact to the welfare of human life(atomic energy control, airplane, spaceship, transportation, combustion control, all types of safety device, etc.). AUK Corp. cannot accept liability to any damage which may occur in case these AUK Corp. products were used in the mentioned equipments without prior consultation with AUK Corp..

Specifications mentioned in this publication are subject to change without notice.