

SWITCHING REGULATOR APPLICATIONS

Features

- High Voltage : $BV_{DSS}=650V(\text{Min.})$
- Low C_{RSS} : $C_{RSS}=5.6pF(\text{Typ.})$
- Low gate charge : $Qg=11.2nC(\text{Typ.})$
- Low $R_{DS(on)}$: $R_{DS(on)}=3.0\Omega(\text{Max.})$

Ordering Information

| Type No. | Marking | Package Code |
|-----------|---------|---------------------------|
| SMK0465FJ | SMK0465 | TO-220F-3L (J Forming) |

PIN Connection

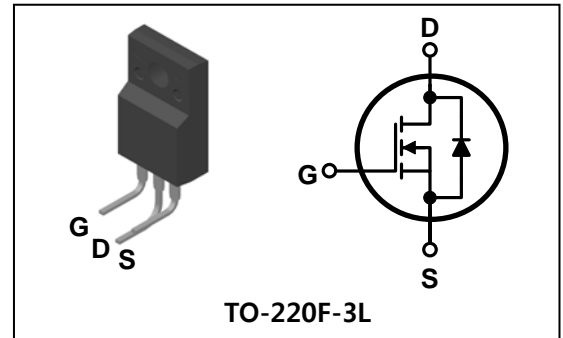

Marking Diagram

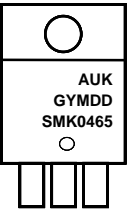
| | |
|--|---|
|  | Column 1 : Manufacturer |
| | Column 2 : Production Information e.g.) GYMDD |
| | - G : Factory management code - YMDD : Date Code (year, month, date) |
| | Column 3 : Device Code |

Absolute maximum ratings ($T_C=25^\circ\text{C}$ unless otherwise noted)

| Characteristic | Symbol | Rating | Unit | |
|----------------------------------|-----------|-------------------------|------------------|---|
| Drain-source voltage | V_{DSS} | 650 | V | |
| Gate-source voltage | V_{GSS} | ± 30 | V | |
| Drain current (DC) * | I_D | $T_C=25^\circ\text{C}$ | 4 | A |
| | | $T_C=100^\circ\text{C}$ | 2.0 | A |
| Drain current (Pulsed) * | I_{DM} | 16 | A | |
| Power dissipation | P_D | 30 | W | |
| Avalanche current (Single) ② | I_{AS} | 4 | A | |
| Single pulsed avalanche energy ② | E_{AS} | 81.5 | mJ | |
| Avalanche current (Repetitive) ① | I_{AR} | 4 | A | |
| Repetitive avalanche energy ① | E_{AR} | 3.4 | mJ | |
| Junction temperature | T_J | 150 | $^\circ\text{C}$ | |
| Storage temperature range | T_{stg} | -55~150 | | |

* Limited by maximum junction temperature

| Characteristic | Symbol | Typ. | Max. | Unit |
|--------------------|------------------|------|------|--------------------|
| Thermal resistance | Junction-case | - | 4.16 | $^\circ\text{C/W}$ |
| | Junction-ambient | - | 62.5 | |

Electrical Characteristics (T_C=25°C unless otherwise noted)

| Characteristic | Symbol | Test Condition | Min. | Typ. | Max. | Unit | |
|--------------------------------|---------------------|---|------|------|------|------|---|
| Drain-source breakdown voltage | BV _{DSS} | I _D =250μA, V _{GS} =0 | 650 | - | - | V | |
| Gate threshold voltage | V _{GS(th)} | I _D =250μA, V _{DS} =V _{GS} | 2.0 | - | 4.0 | V | |
| Drain-source cut-off current | I _{DSS} | V _{DS} =650V, V _{GS} =0V | - | - | 1 | μA | |
| Gate leakage current | I _{GSS} | V _{DS} =0V, V _{GS} =±30V | - | - | ±100 | nA | |
| Drain-source on-resistance ④ | R _{DS(ON)} | V _{GS} =10V, I _D =2.0A | - | 2.4 | 3.0 | Ω | |
| Forward transfer conductance ④ | g _{fs} | V _{DS} =10V, I _D =2.0A | - | 4.0 | - | S | |
| Input capacitance | C _{iss} | V _{GS} =0V, V _{DS} =25V, f=1MHz | - | 703 | 878 | pF | |
| Output capacitance | C _{oss} | | - | 54.6 | 68.2 | | |
| Reverse transfer capacitance | C _{rss} | | - | 5.6 | 7.0 | | |
| Turn-on delay time | t _{d(on)} | V _{DD} =300V, I _D =4.0A R _G =25Ω | - | 10 | - | ns | |
| Rise time | t _r | | - | 42 | - | | |
| Turn-off delay time | t _{d(off)} | | ③④ | - | 38 | | - |
| Fall time | t _f | | - | 46 | - | | |
| Total gate charge | Q _g | V _{DS} =520V, V _{GS} =10V I _D =4.0A | - | 11.2 | 14.0 | nC | |
| Gate-source charge | Q _{gs} | | - | 3.9 | - | | |
| Gate-drain charge | Q _{gd} | | ③④ | - | 2.5 | | - |

Source-Drain Diode Ratings and Characteristics (T_C=25°C unless otherwise noted)

| Characteristic | Symbol | Test Condition | Min. | Typ. | Max. | Unit |
|---------------------------|-----------------|--|------|------|------|------|
| Source current (DC) | I _S | Integral reverse diode in the MOSFET | - | - | 4 | A |
| Source current (Pulsed) ① | I _{SM} | | - | - | 16 | |
| Forward voltage ④ | V _{SD} | V _{GS} =0V, I _S =4.0A | - | - | 1.4 | V |
| Reverse recovery time | t _{rr} | I _S =4.0A, V _{GS} =0V dI _F /dt=100A/μs | - | 300 | - | ns |
| Reverse recovery charge | Q _{rr} | | - | 2.2 | - | μC |

Note ;

- ① Repetitive rating : Pulse width limited by maximum junction temperature
- ② L=9.4mH, I_{AS}=4.0A, V_{DD}=50V, R_G=25Ω, Starting T_J=25°C
- ③ Pulse Test : Pulse width≤300μs, Duty cycle≤2%
- ④ Essentially independent of operating temperature

Electrical Characteristic Curves

Fig. 1 $I_D - V_{DS}$

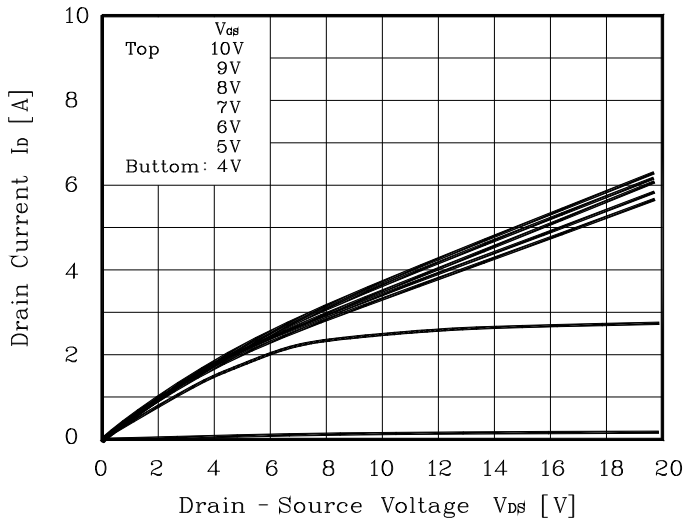

Fig. 2 $I_D - V_{GS}$

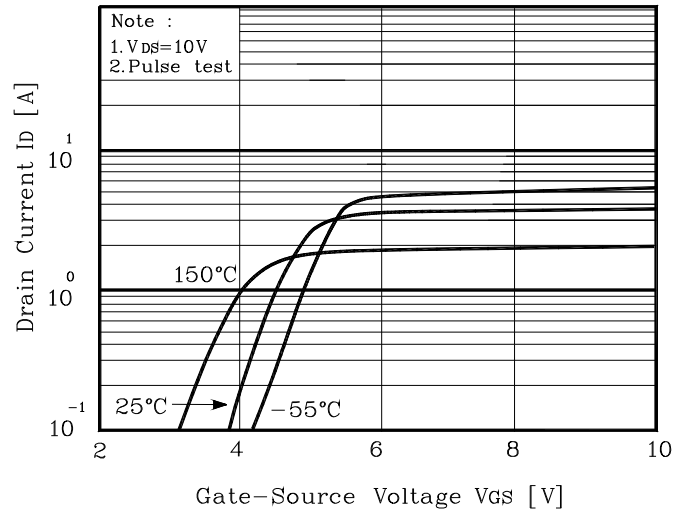

Fig. 3 $R_{DS(on)} - I_D$

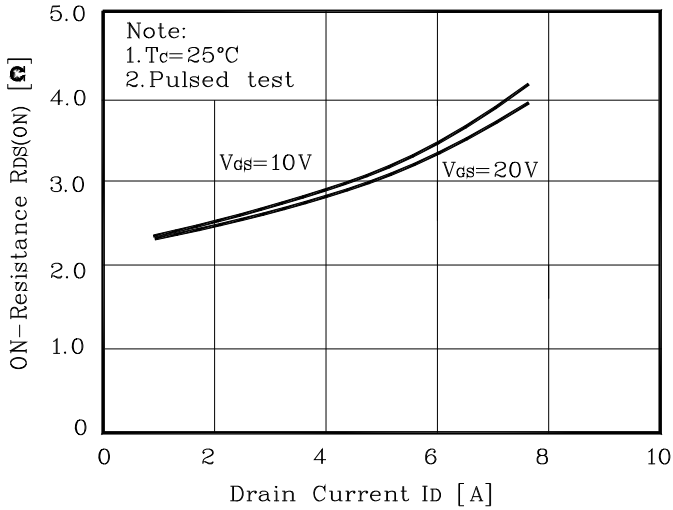

Fig. 4 $I_S - V_{SD}$

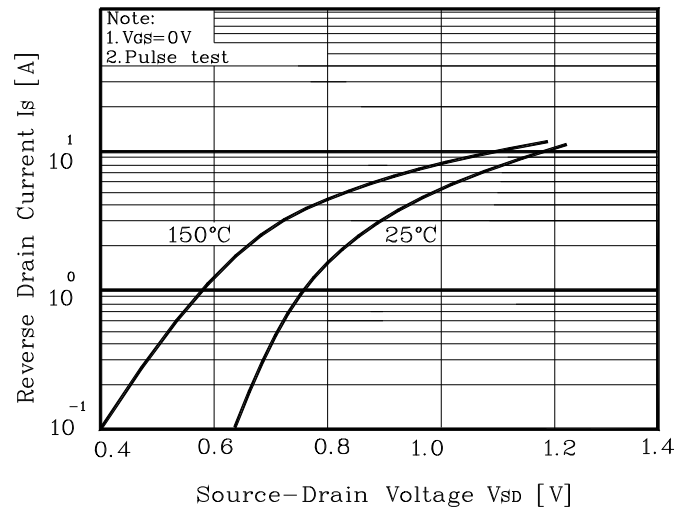

Fig. 5 Capacitance - V_{DS}

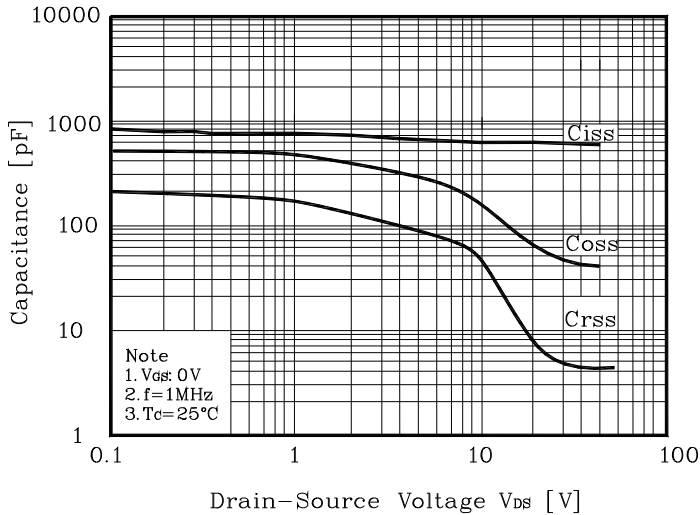
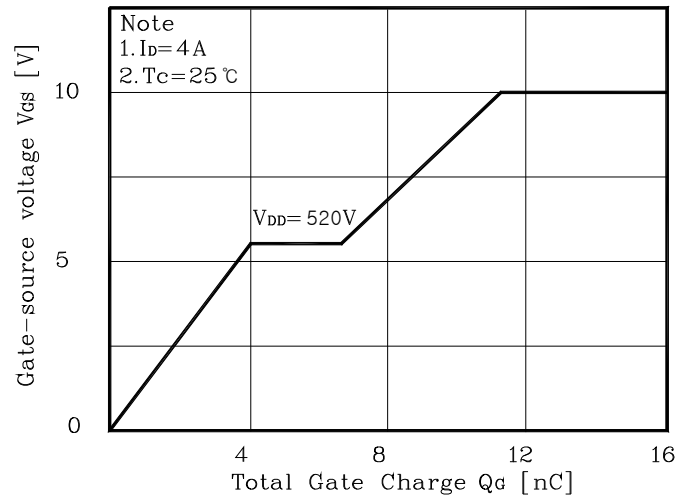

Fig. 6 $V_{GS} - Q_G$



Electrical Characteristic Curves

Fig. 7 $V_{DSS} - T_J$

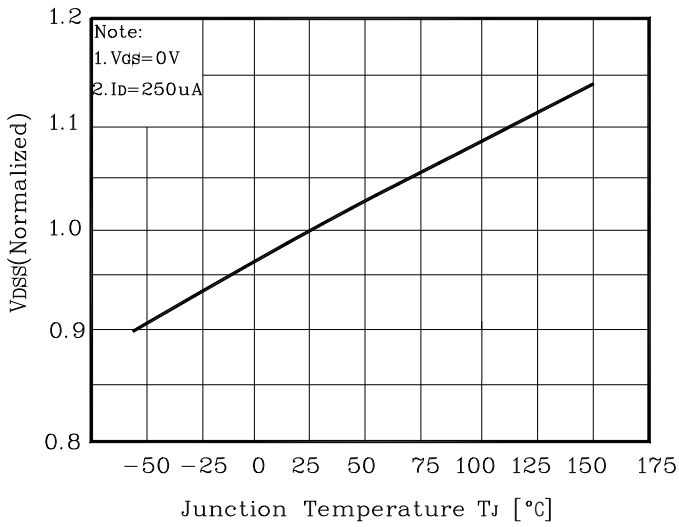

Fig. 8 $R_{DS(on)} - T_J$

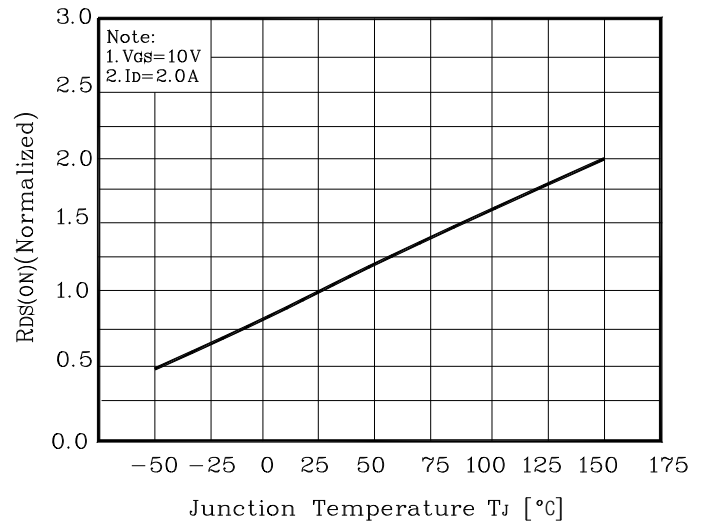

Fig. 9 $I_D - T_C$

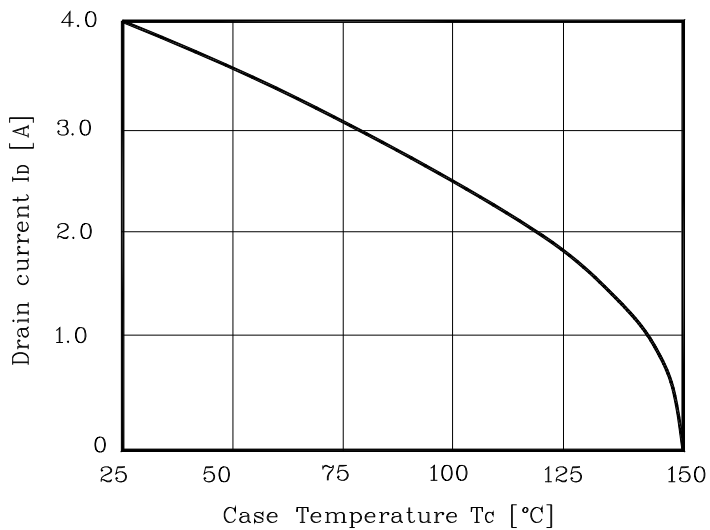

Fig. 10 Safe Operating Area

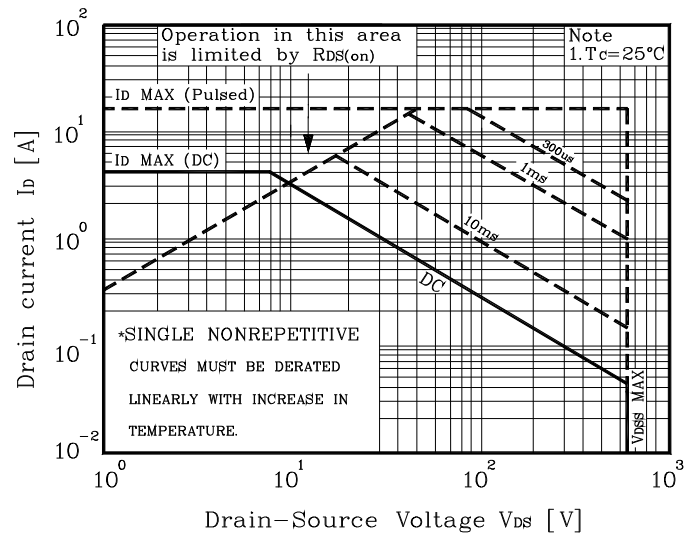

Fig. 11 Gate Charge Test Circuit & Waveform

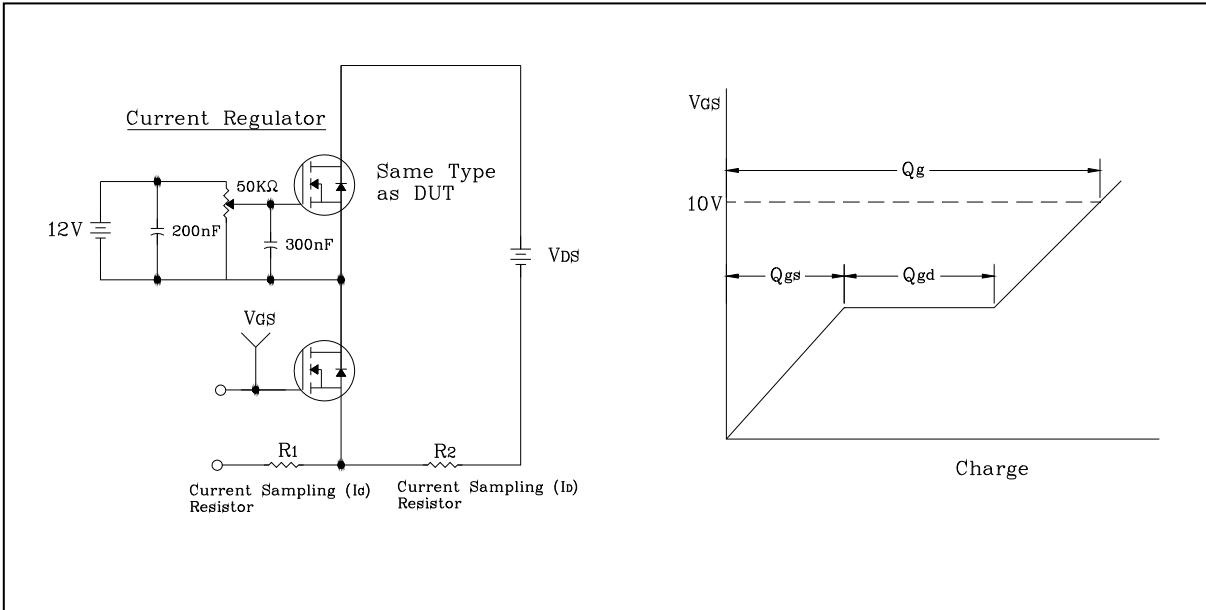

Fig. 12 Resistive Switching Test Circuit & Waveform

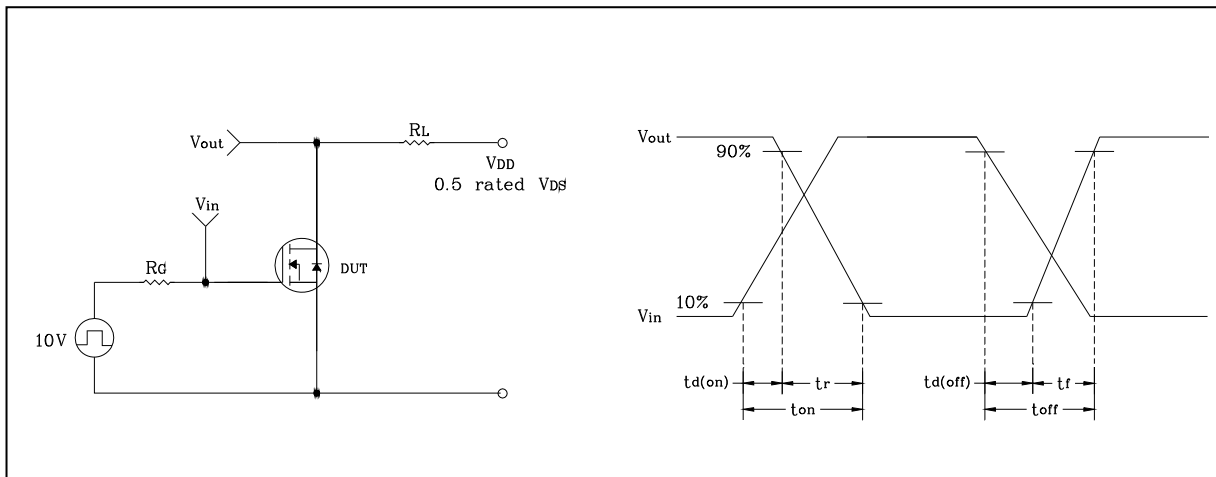

Fig. 13 EAS Test Circuit & Waveform

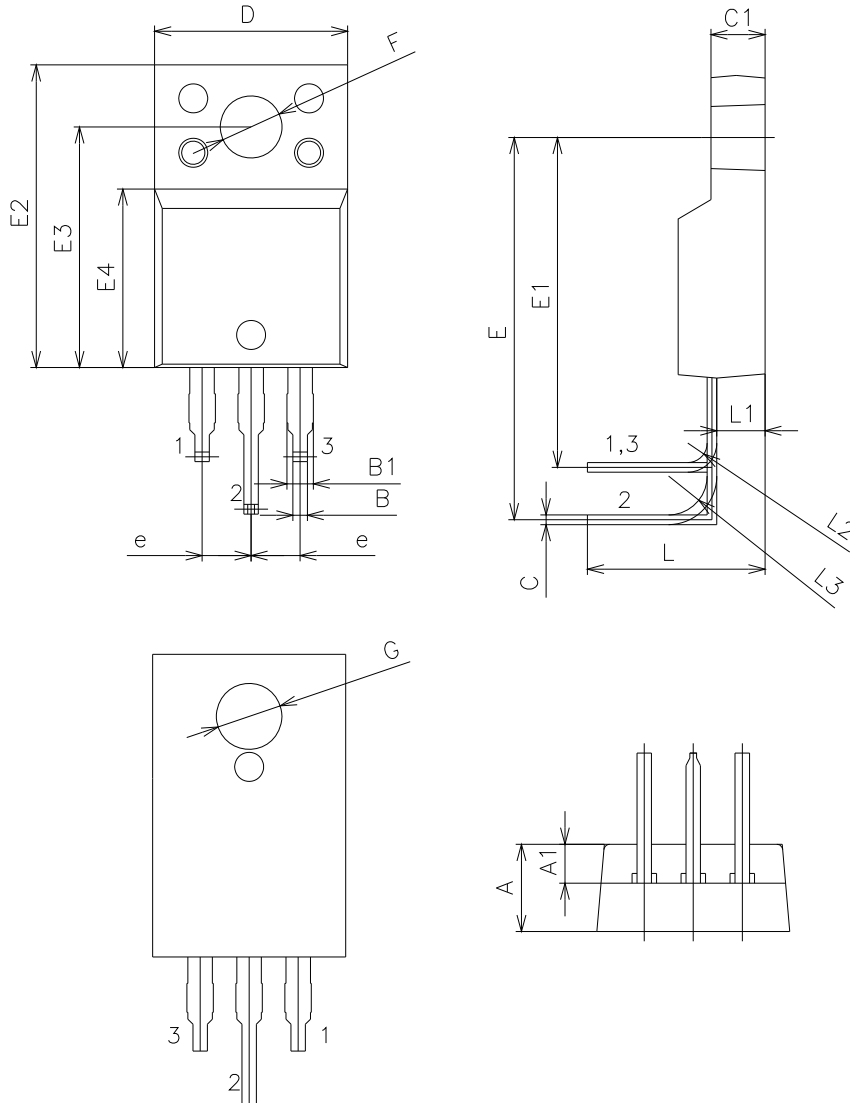

Fig. 14 Diode Reverse Recovery Time Test Circuit & Waveform



Outline Dimension

unit: mm



| SYMBOL | MILLIMETERS | | | NOTE |
|--------|-------------|---------|---------|------|
| | MINIMUM | NOMINAL | MAXIMUM | |
| A | 4.40 | 4.50 | 4.60 | |
| A1 | 1.90 | 2.00 | 2.10 | |
| B | 0.65 | 0.75 | 0.85 | |
| B1 | 1.07 | 1.27 | 1.47 | |
| C | 0.40 | 0.50 | 0.60 | |
| C1 | 2.70 | 2.80 | 2.90 | |
| D | 9.80 | 10.00 | 10.20 | |
| E | 19.20 | 19.70 | 20.20 | |
| E1 | 16.50 | 17.00 | 17.50 | |
| E2 | 15.40 | 15.60 | 15.80 | |
| E3 | 12.20 | 12.40 | 12.60 | |
| E4 | 9.00 | 9.20 | 9.40 | |
| F | 3.10 | 3.20 | 3.30 | |
| G | 3.30 | 3.40 | 3.50 | |
| e | 2.54 BSC | | | |
| L | 9.00 | 9.20 | 9.40 | |
| L1 | - | 2.50 | - | |
| L2 | - | 1.00 | - | |
| L3 | - | 2.00 | - | |

The AUK Corp. products are intended for the use as components in general electronic equipment (Office and communication equipment, measuring equipment, home appliance, etc.).

Please make sure that you consult with us before you use these AUK Corp. products in equipments which require high quality and / or reliability, and in equipments which could have major impact to the welfare of human life(atomic energy control, airplane, spaceship, transportation, combustion control, all types of safety device, etc.). AUK Corp. cannot accept liability to any damage which may occur in case these AUK Corp. products were used in the mentioned equipments without prior consultation with AUK Corp..

Specifications mentioned in this publication are subject to change without notice.