

SWITCHING REGULATOR APPLICATIONS

Features

- High Voltage : $BV_{DSS}=600V(\text{Min.})$
- Low C_{rss} : $C_{rss}=3.4pF(\text{Typ.})$
- Low gate charge : $Qg=3.9nC(\text{Typ.})$
- Low $R_{DS(on)}$: $R_{DS(on)}=11.5\Omega(\text{Max.})$

Ordering Information

Type No.	Marking	Package Code
SMK0160D	SMK0160	TO-252

PIN Connection

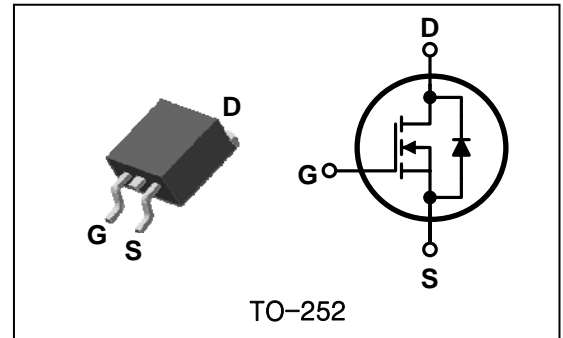

Marking Diagram

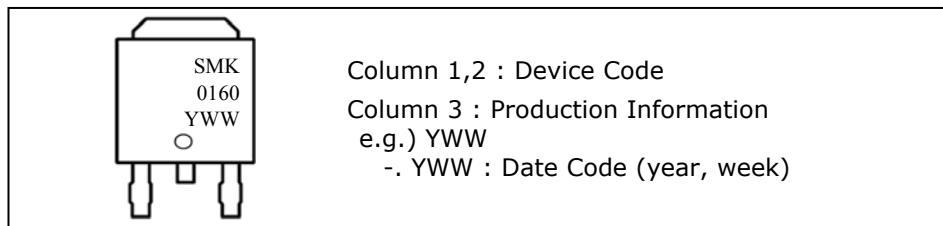

Absolute maximum ratings ($T_C=25^\circ\text{C}$ unless otherwise noted)

Characteristic	Symbol	Rating	Unit
Drain-source voltage	V_{DSS}	600	V
Gate-source voltage	V_{GSS}	± 30	V
Drain current (DC) *	I_D	($T_C=25^\circ\text{C}$)	1.0
		($T_C=100^\circ\text{C}$)	0.77
Drain current (Pulsed) *	I_{DM}	4.0	A
Power dissipation	P_D	28	W
Avalanche current (Single) ②	I_{AS}	1.0	A
Single pulsed avalanche energy ②	E_{AS}	22	mJ
Avalanche current (Repetitive) ①	I_{AR}	1.0	A
Repetitive avalanche energy ①	E_{AR}	2.5	mJ
Junction temperature	T_J	150	$^\circ\text{C}$
Storage temperature range	T_{stg}	-55~150	

* Limited by maximum junction temperature

Characteristic	Symbol	Typ.	Max.	Unit
Thermal resistance	Junction-case	$R_{th(J-C)}$	-	4.46
	Junction-ambient	$R_{th(J-A)}$	-	62.5

Electrical Characteristics (T_C=25°C unless otherwise noted)

Characteristic	Symbol	Test Condition	Min.	Typ.	Max.	Unit	
Drain-source breakdown voltage	BV _{DSS}	I _D =250μA, V _{GS} =0	600	-	-	V	
Gate threshold voltage	V _{GS(th)}	I _D =250μA, V _{DS} =V _{GS}	2.0	-	4.0	V	
Drain-source cut-off current	I _{DSS}	V _{DS} =600V, V _{GS} =0V	-	-	1	μA	
Gate leakage current	I _{GSS}	V _{DS} =0V, V _{GS} =±30V	-	-	±100	nA	
Drain-source on-resistance ④	R _{DS(ON)}	V _{GS} =10V, I _D =0.5A	-	9.3	11.5	Ω	
Forward transfer conductance ④	g _{fs}	V _{DS} =10V, I _D =0.5A	-	0.32	-	S	
Input capacitance	C _{iss}	V _{GS} =0V, V _{DS} =25V, f=1MHz	-	131	164	pF	
Output capacitance	C _{oss}		-	19.4	24.3		
Reverse transfer capacitance	C _{rss}		-	3.4	4.3		
Turn-on delay time	t _{d(on)}	V _{DD} =300V, I _D =1.0A R _G =25Ω	-	5.5	-	ns	
Rise time	t _r		-	5	-		
Turn-off delay time	t _{d(off)}		③④	-	13		-
Fall time	t _f		-	-	28		-
Total gate charge	Q _g	V _{DS} =480V, V _{GS} =10V I _D =1.0A	-	3.9	4.9	nC	
Gate-source charge	Q _{gs}		-	1.7	-		
Gate-drain charge	Q _{gd}		③④	-	0.85		-

Source-Drain Diode Ratings and Characteristics (T_C=25°C unless otherwise noted)

Characteristic	Symbol	Test Condition	Min.	Typ.	Max.	Unit
Source current (DC)	I _S	Integral reverse diode in the MOSFET	-	-	1.0	A
Source current (Pulsed) ①	I _{SM}		-	-	4.0	
Forward voltage ④	V _{SD}	V _{GS} =0V, I _S =1.0A	-	-	1.4	V
Reverse recovery time	t _{rr}	I _S =1.0A, V _{GS} =0V dI _F /dt=100A/μs	-	190	-	ns
Reverse recovery charge	Q _{rr}		-	0.53	-	μC

Note ;

- ① Repetitive rating : Pulse width limited by maximum junction temperature
- ② L=1080mH, I_{AS}=0.3A, V_{DD}=50V, R_G=25Ω, Starting T_J=25°C
- ③ Pulse Test : Pulse width≤300μs, Duty cycle≤2%
- ④ Essentially independent of operating temperature

Electrical Characteristic Curves

Fig. 1 $I_D - V_{DS}$

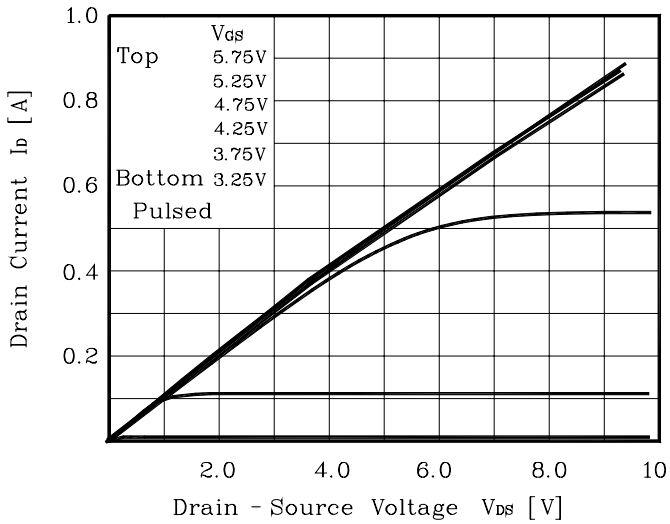

Fig. 2 $I_D - V_{GS}$

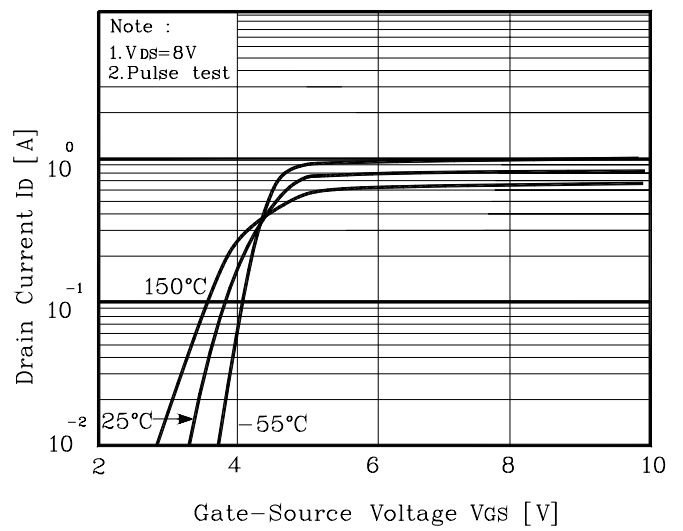

Fig. 3 $R_{DS(on)} - I_D$

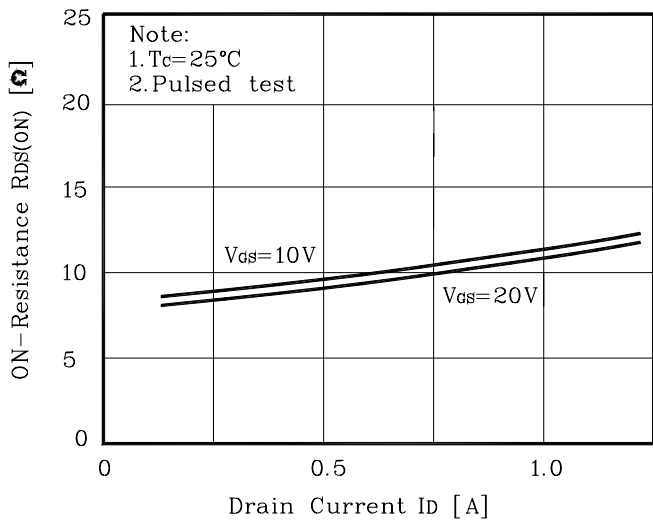

Fig. 4 $I_S - V_{SD}$

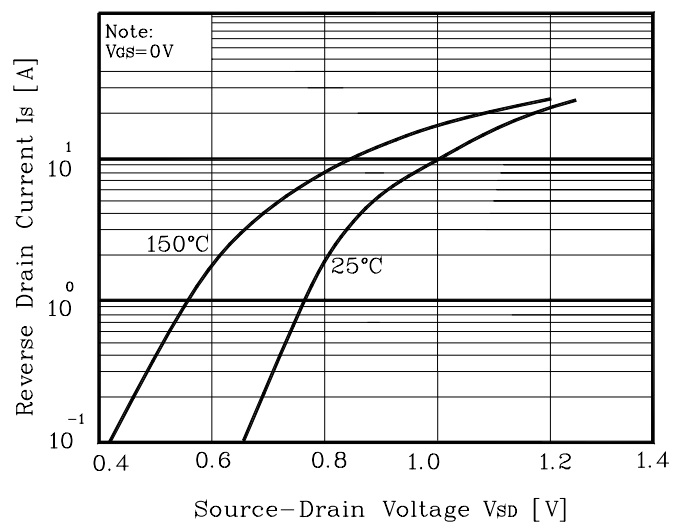

Fig. 5 Capacitance - V_{DS}

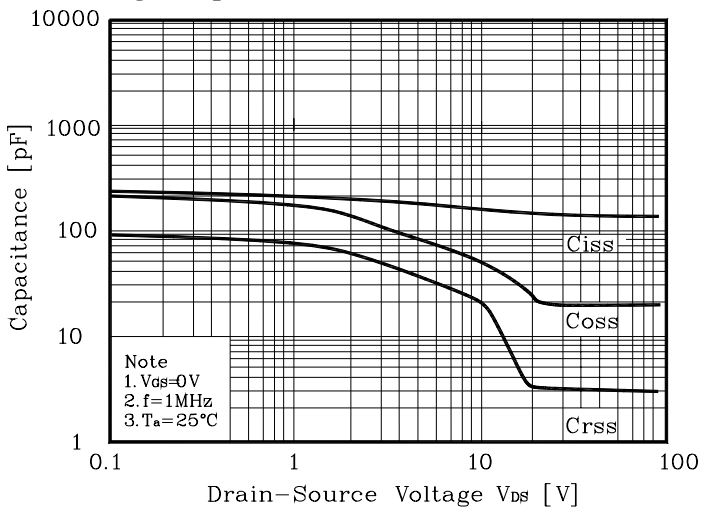

Fig. 6 $V_{GS} - Q_G$

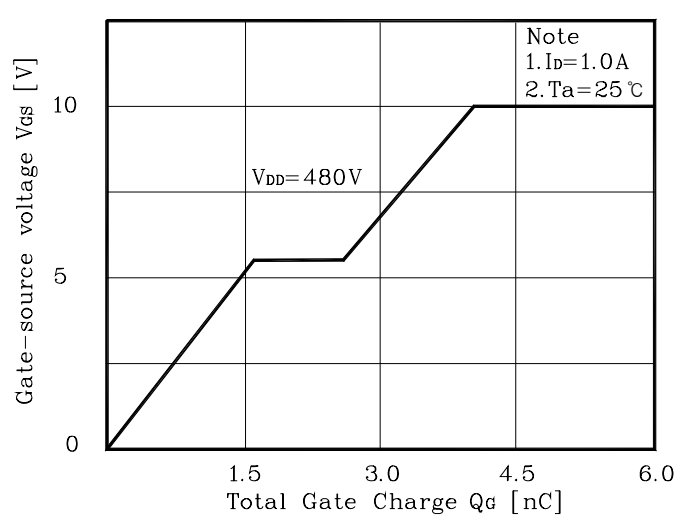

Fig. 7 $V_{DSS} - T_J$

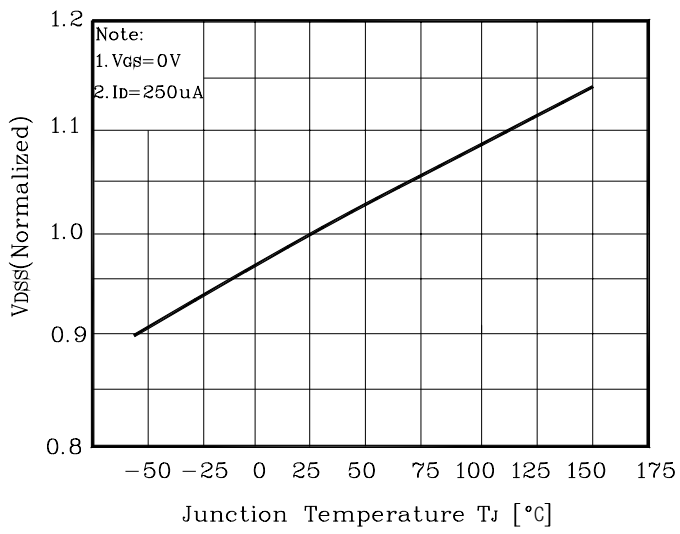

Fig. 8 $R_{DS(on)} - T_J$

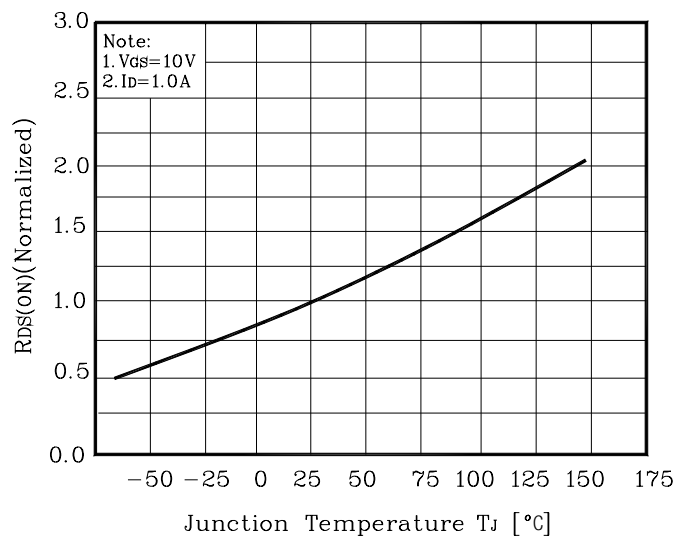

Fig. 9 $I_D - T_c$

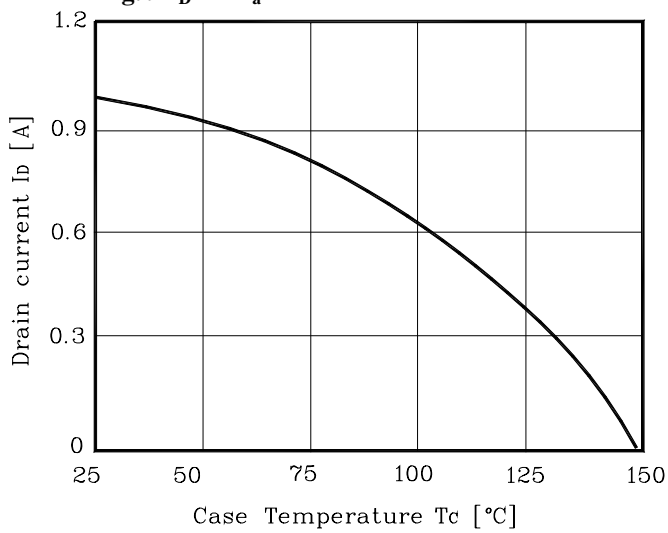

Fig. 10 Safe Operating Area

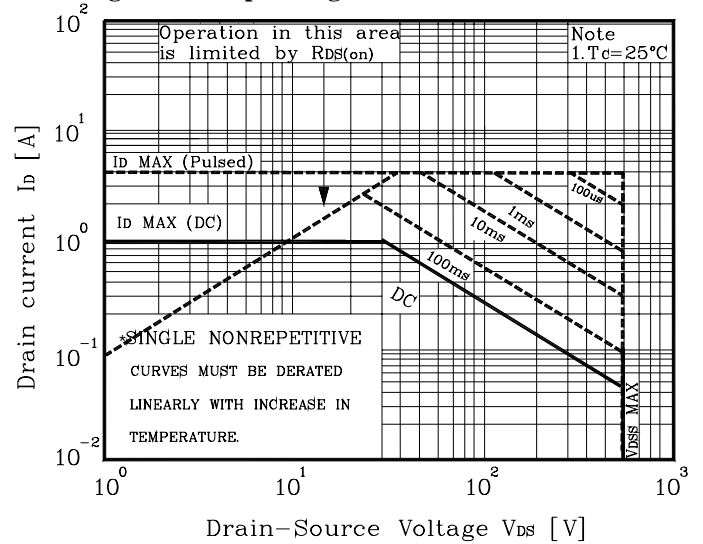

Fig. 11 Gate Charge Test Circuit & Waveform

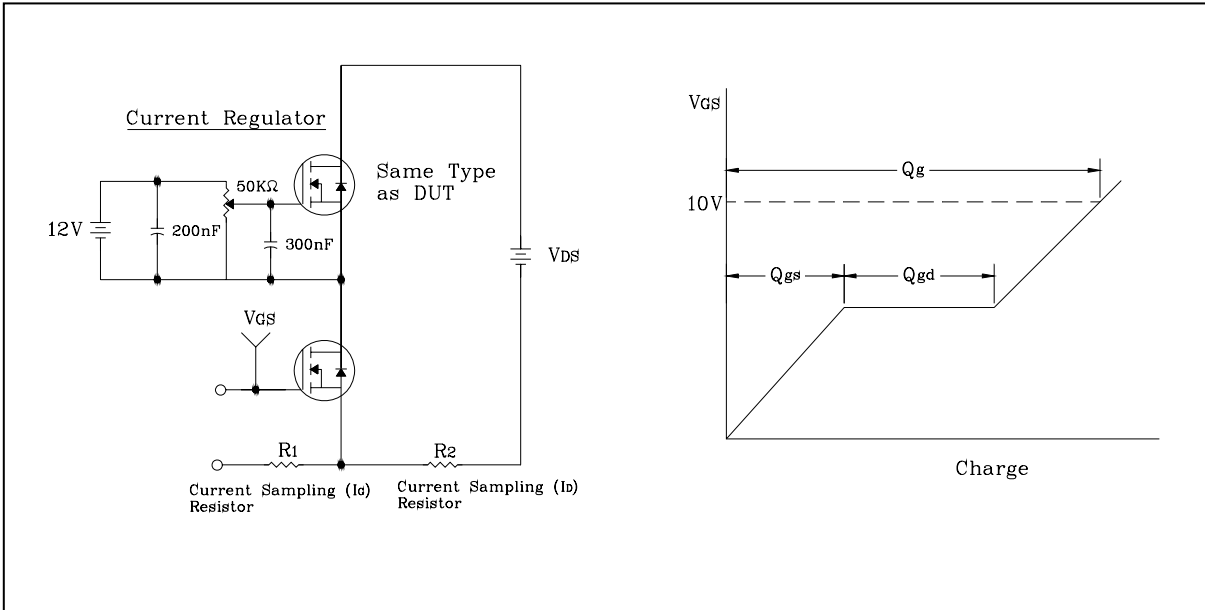

Fig. 12 Resistive Switching Test Circuit & Waveform

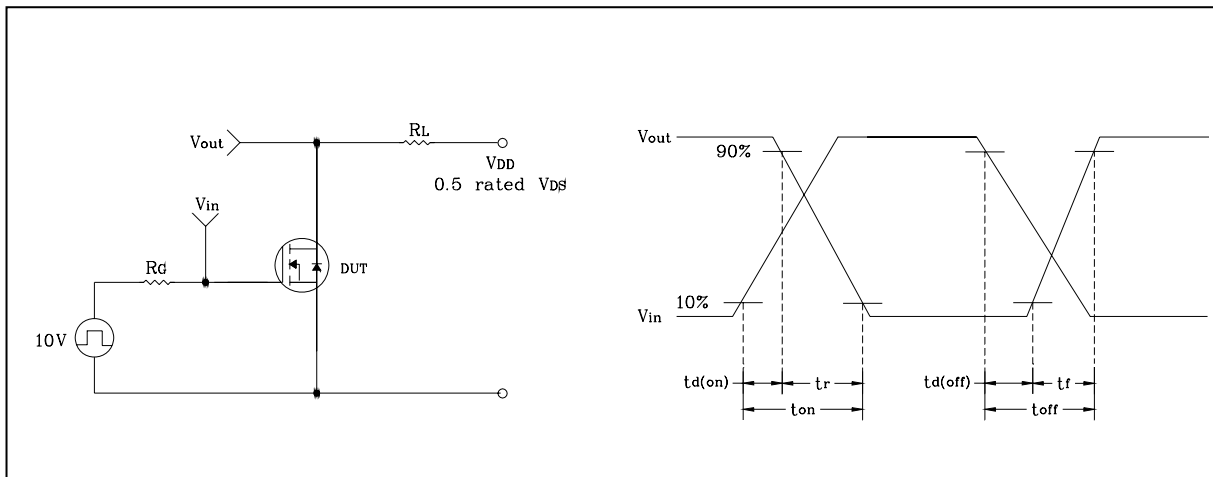

Fig. 13 E_{AS} Test Circuit & Waveform

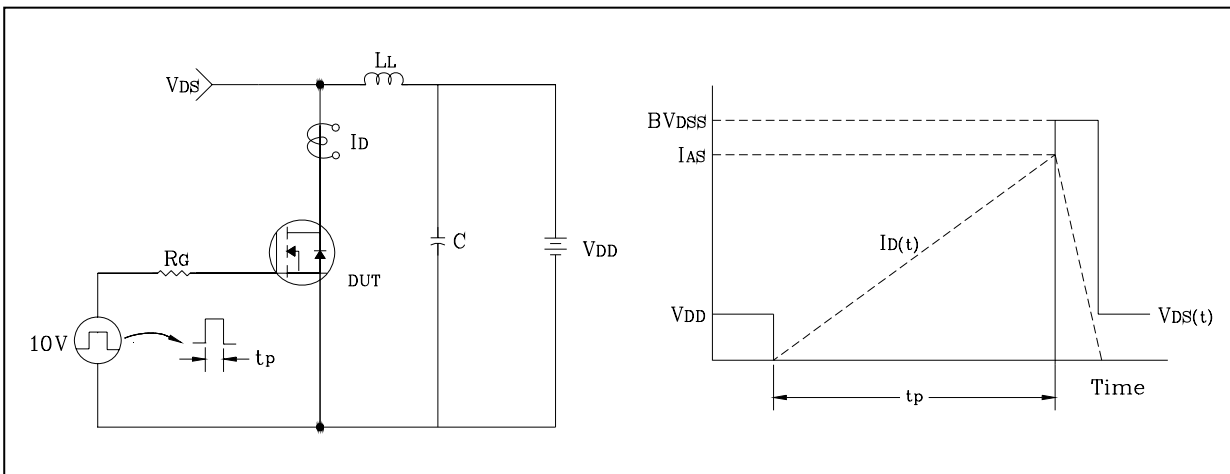
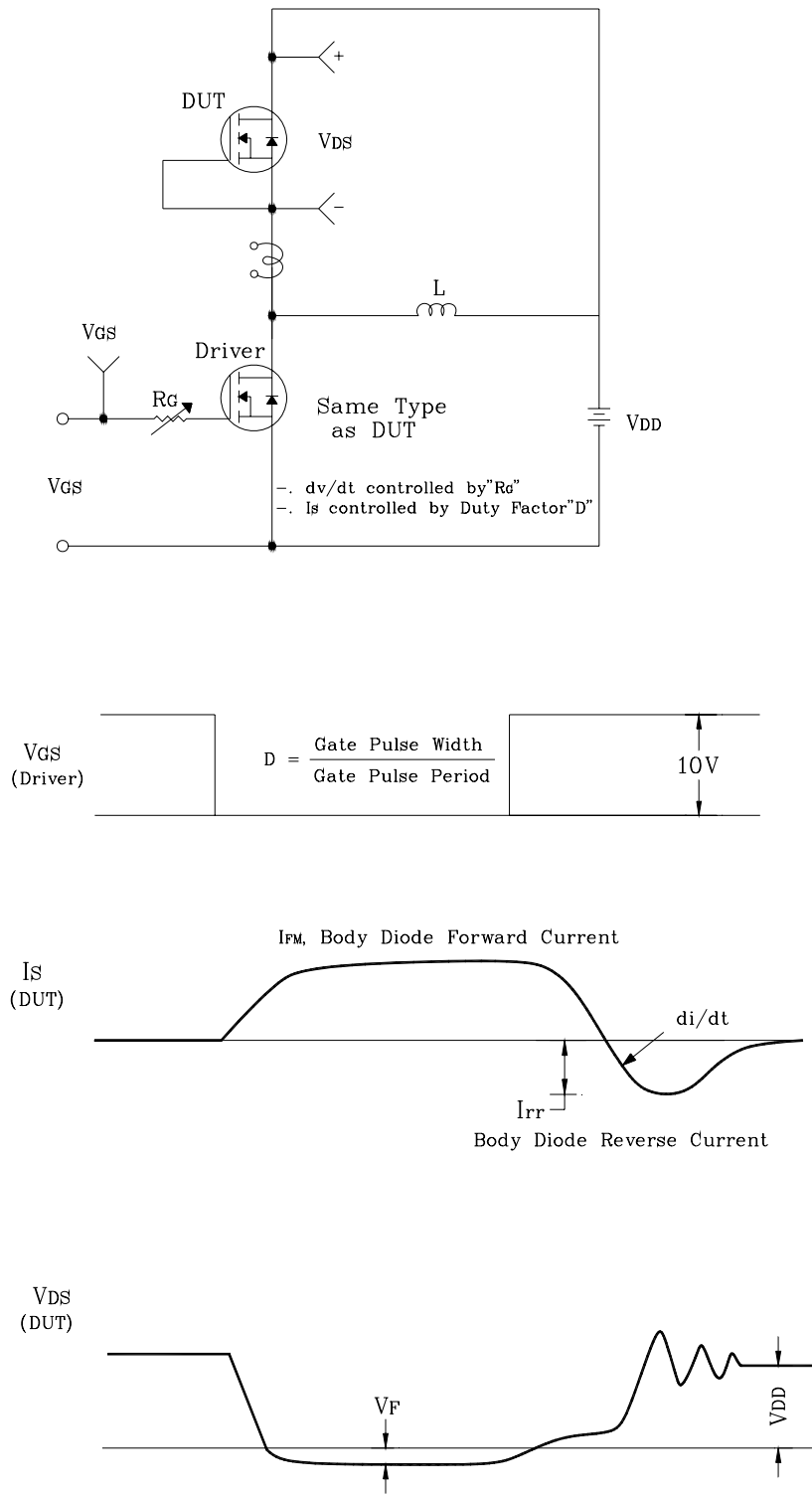
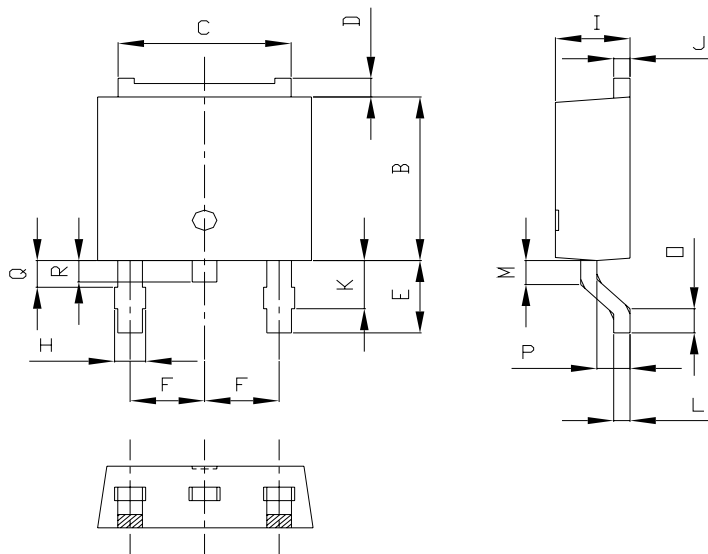

Fig. 14 Diode Reverse Recovery Time Test Circuit & Waveform



Outline Dimension

unit: mm



SYMBOL	MILLIMETERS			NOTE
	MINIMUM	NOMINAL	MAXIMUM	
A	6.40	6.60	6.80	
B	5.90	6.10	6.30	
C	5.04	5.34	5.64	
D	0.50	0.70	0.90	
E	2.50	2.70	2.90	
F	2.10	2.30	2.50	
H	0.96 MAX			
I	2.20	2.30	2.40	
J	0.40	0.50	0.60	
K	1.60	1.80	2.00	
L	0.40	0.50	0.60	
M	0.81	0.91	1.01	
O	0.80	0.90	1.00	
P	0.90	1.00	1.10	
Q	0.95 MAX			
R	0.60	0.80	1.00	

Recommended Land Pattern [unit: mm]

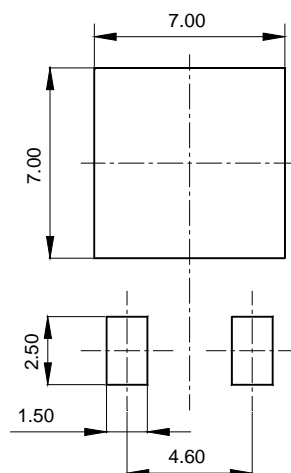

The AUK Corp. products are intended for the use as components in general electronic equipment (Office and communication equipment, measuring equipment, home appliance, etc.).

Please make sure that you consult with us before you use these AUK Corp. products in equipments which require high quality and / or reliability, and in equipments which could have major impact to the welfare of human life(atomic energy control, airplane, spaceship, transportation, combustion control, all types of safety device, etc.). AUK Corp. cannot accept liability to any damage which may occur in case these AUK Corp. products were used in the mentioned equipments without prior consultation with AUK Corp..

Specifications mentioned in this publication are subject to change without notice.