

N-Channel Enhancement Mode Field Effect Transistor

FEATURES

- 650V, 0.3A, $R_{DS(ON)} = 15 \Omega$ @ $V_{GS} = 10V$.
- High dense cell design for extremely low $R_{DS(ON)}$.
- Rugged and reliable.
- Lead free product is acquired.
- TO-92(Bulk) & TO-92(Ammopack) package.

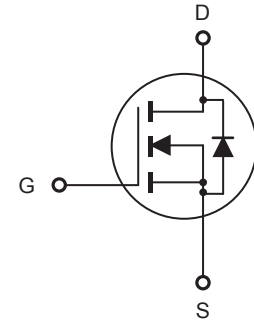
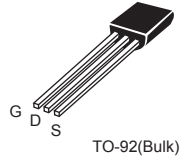
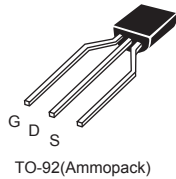

ABSOLUTE MAXIMUM RATINGS $T_A = 25^\circ\text{C}$ unless otherwise noted

Parameter	Symbol	Limit	Units
Drain-Source Voltage	V_{DS}	650	V
Gate-Source Voltage	V_{GS}	± 30	V
Drain Current-Continuous	I_D	0.3	A
Drain Current-Pulsed ^a	I_{DM}	1.2	A
Maximum Power Dissipation	P_D	3.1	W
Operating and Store Temperature Range	T_J, T_{stg}	-55 to 150	$^\circ\text{C}$

Thermal Characteristics

Parameter	Symbol	Limit	Units
Thermal Resistance, Junction-to-Lead ^b	$R_{\theta JL}$	40	$^\circ\text{C/W}$



CEK01N65A

Electrical Characteristics $T_C = 25^\circ\text{C}$ unless otherwise noted

Parameter	Symbol	Test Condition	Min	Typ	Max	Units
Off Characteristics						
Drain-Source Breakdown Voltage	BV_{DSS}	$V_{GS} = 0V, I_D = 250\mu A$	650			V
Zero Gate Voltage Drain Current	I_{DSS}	$V_{DS} = 650V, V_{GS} = 0V$			1	μA
Gate Body Leakage Current, Forward	I_{GSSF}	$V_{GS} = 30V, V_{DS} = 0V$			100	nA
Gate Body Leakage Current, Reverse	I_{GSSR}	$V_{GS} = -30V, V_{DS} = 0V$			-100	nA
On Characteristics						
Gate Threshold Voltage	$V_{GS(th)}$	$V_{GS} = V_{DS}, I_D = 250\mu A$	2		4	V
Static Drain-Source On-Resistance	$R_{DS(on)}$	$V_{GS} = 10V, I_D = 0.2A$		12	15	Ω
Dynamic Characteristics ^c						
Forward Transconductance	g_{FS}^b	$V_{DS} = 20V, I_D = 0.3A$		0.5		S
Input Capacitance	C_{iss}	$V_{DS} = 25V, V_{GS} = 0V, f = 1.0\text{ MHz}$		170		pF
Output Capacitance	C_{oss}			60		pF
Reverse Transfer Capacitance	C_{rss}			30		pF
Switching Characteristics ^c						
Turn-On Delay Time	$t_{d(on)}$	$V_{DD} = 300V, I_D = 0.3A, V_{GS} = 10V, R_{GEN} = 4.7\Omega$		10	20	ns
Turn-On Rise Time	t_r			11	22	ns
Turn-Off Delay Time	$t_{d(off)}$			24	48	ns
Turn-Off Fall Time	t_f			62	124	ns
Total Gate Charge	Q_g	$V_{DS} = 480V, I_D = 0.3A, V_{GS} = 10V$		10	12.8	nC
Gate-Source Charge	Q_{gs}			0.6		nC
Gate-Drain Charge	Q_{gd}			7.5		nC
Drain-Source Diode Characteristics and Maximum Ratings						
Drain-Source Diode Forward Current	I_S				0.3	A
Drain-Source Diode Forward Voltage ^b	V_{SD}	$V_{GS} = 0V, I_S = 0.2A$			1.6	V
Notes : □ a.Repetitive Rating : Pulse width limited by maximum junction temperature. b.Pulse Test : Pulse Width $\leq 300\mu s$, Duty Cycle $\leq 2\%$. □ c.Guaranteed by design, not subject to production testing. □						



CEK01N65A

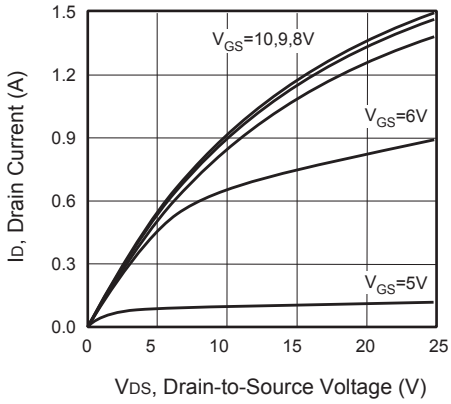

Figure 1. Output Characteristics

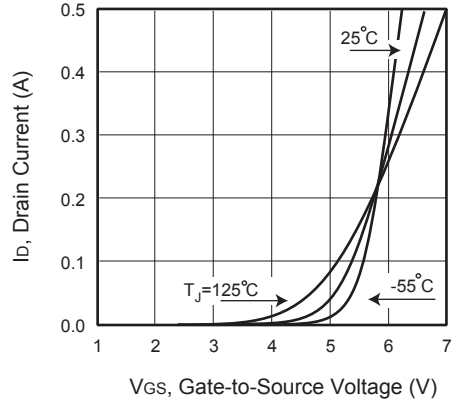

Figure 2. Transfer Characteristics

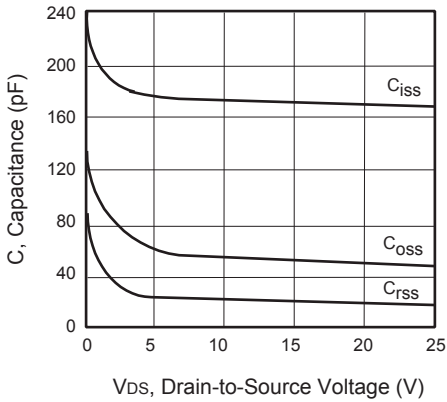

Figure 3. Capacitance

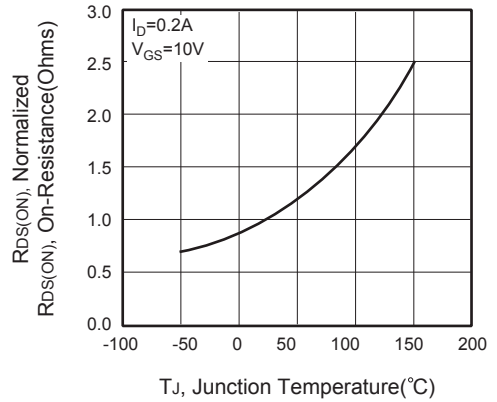

Figure 4. On-Resistance Variation with Temperature



Figure 5. Gate Threshold Variation with Temperature

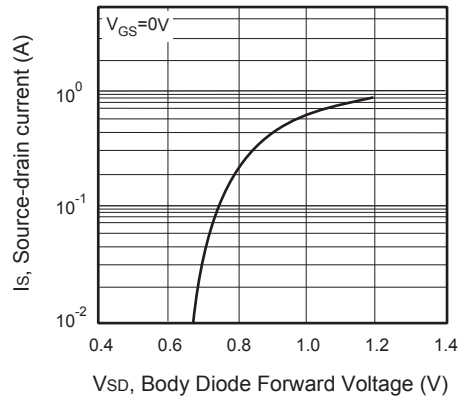

Figure 6. Body Diode Forward Voltage Variation with Source Current



CEK01N65A

6

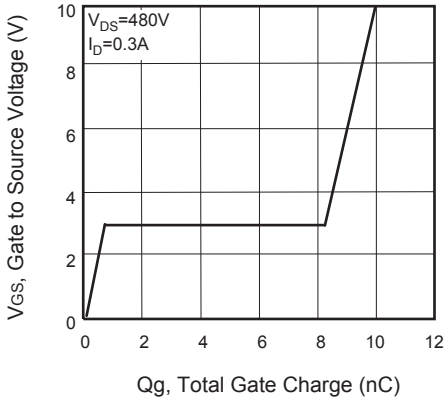

Figure 7. Gate Charge

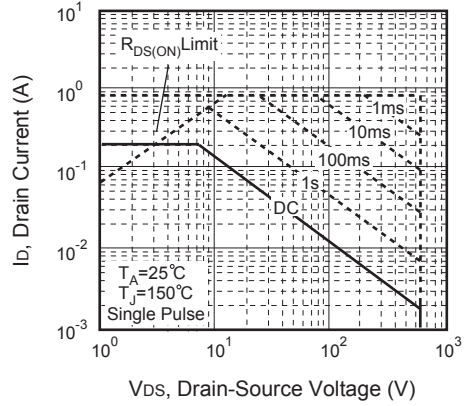

Figure 8. Maximum Safe Operating Area

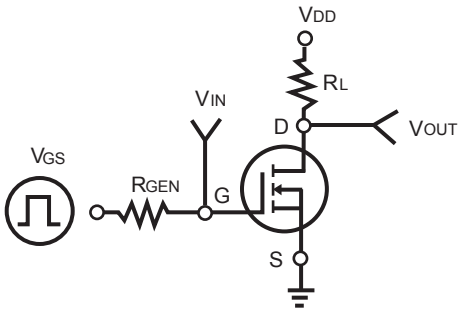

Figure 9. Switching Test Circuit

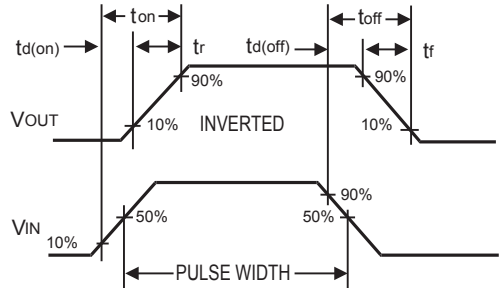

Figure 10. Switching Waveforms

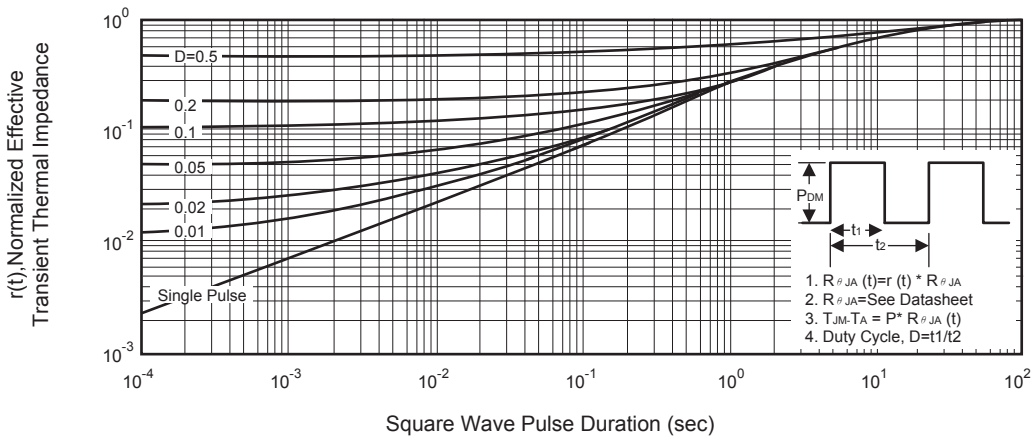

Figure 11. Normalized Thermal Transient Impedance Curve