



### General Description

AFP9577, P-Channel enhancement mode MOSFET, uses Advanced Trench Technology to provide excellent  $R_{DS(ON)}$ , low gate charge.

These devices are particularly suited for low voltage power management, and low in-line power loss are needed in commercial industrial surface mount applications.

### Features

- -60V/-4A,  $R_{DS(ON)} = 305m\Omega @ V_{GS} = -10V$
- -60V/-3A,  $R_{DS(ON)} = 330m\Omega @ V_{GS} = -4.5V$
- Super high density cell design for extremely low  $R_{DS(ON)}$
- TO-252-2L package design

### Pin Description ( TO-252-2L )

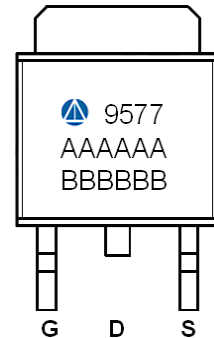
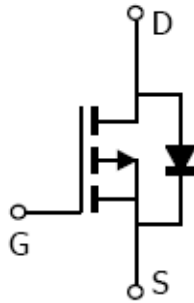
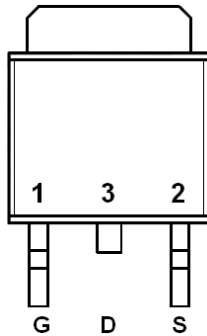

### Application

- Backlight Inverter for LCD Display
- Full Bridge DC/DC Converter
- LED Display
- Load Switch
- CCFL Inverter

### Pin Define

Pin	Symbol	Description
1	G	Gate
2	S	Source
3	D	Drain

### Ordering Information

Part Ordering No.	Part Marking	Package	Unit	Quantity
AFP9577T252RG	9577	TO-252-2L	Tape & Reel	2500 EA

※ A Lot code

※ B Date code

※ AFP9577T252RG : 13" Tape & Reel ; Pb- Free ; Halogen- Free



**Absolute Maximum Ratings**

(T<sub>A</sub>=25°C Unless otherwise noted)

Parameter	Symbol	Typical	Unit
Drain-Source Voltage	V <sub>DSS</sub>	-60	V
Gate –Source Voltage	V <sub>GSS</sub>	±20	V
Continuous Drain Current(T <sub>J</sub> =150°C)	I <sub>D</sub>	T <sub>A</sub> =25°C	-7
		T <sub>A</sub> =70°C	-5
Pulsed Drain Current	I <sub>DM</sub>	-8	A
Continuous Source-Drain Diode Current	I <sub>S</sub>	-5	A
Single Pulse Avalanche Current	I <sub>AS</sub>	-6	A
Avalanche Energy	E <sub>AS</sub>	11	mJ
Power Dissipation	P <sub>D</sub>	T <sub>A</sub> =25°C	40
		T <sub>A</sub> =70°C	15
Operating Junction Temperature	T <sub>J</sub>	150	°C
Storage Temperature Range	T <sub>STG</sub>	-55/150	°C
Thermal Resistance-Junction to Ambient	R <sub>θJA</sub>	62.5	°C/W

**Electrical Characteristics**

(T<sub>A</sub>=25°C Unless otherwise noted)

Parameter	Symbol	Conditions	Min.	Typ	Max.	Unit
<b>Static</b>						
Drain-Source Breakdown Voltage	V <sub>(BR)DSS</sub>	V <sub>GS</sub> =0V, I <sub>D</sub> =-250uA	-60			V
Gate Threshold Voltage	V <sub>GS(th)</sub>	V <sub>DS</sub> =V <sub>GS</sub> , I <sub>D</sub> =-250uA	-1.0		-2.0	
Gate Leakage Current	I <sub>GSS</sub>	V <sub>DS</sub> =0V, V <sub>GS</sub> =±12V			±100	nA
Zero Gate Voltage Drain Current	I <sub>DSS</sub>	V <sub>DS</sub> =-48V, V <sub>GS</sub> =0V			-1	uA
		V <sub>DS</sub> =-48V, V <sub>GS</sub> =0V T <sub>J</sub> =85°C			-30	
On-State Drain Current	I <sub>D(on)</sub>	V <sub>DS</sub> ≤ -5V, V <sub>GS</sub> =-10V	-8			A
Drain-Source On-Resistance	R <sub>Ds(on)</sub>	V <sub>GS</sub> =-10V, I <sub>D</sub> =-4A		295	305	mΩ
		V <sub>GS</sub> =-4.5V, I <sub>D</sub> =-3A		310	330	
Forward Transconductance	g <sub>FS</sub>	V <sub>DS</sub> =-10V, I <sub>D</sub> =-3.0A		2.8		S
Diode Forward Voltage	V <sub>SD</sub>	I <sub>S</sub> =-2.0A, V <sub>GS</sub> =0V		-0.75	-1.5	V
<b>Dynamic</b>						
Total Gate Charge	Q <sub>g</sub>	V <sub>DS</sub> =-30V, V <sub>GS</sub> =-4.5V I <sub>D</sub> ≡-2.5A		2.7	4.5	nC
Gate-Source Charge	Q <sub>gs</sub>			0.7		
Gate-Drain Charge	Q <sub>gd</sub>			1.2		
Input Capacitance	C <sub>iss</sub>	V <sub>DS</sub> =-30V, V <sub>GS</sub> =0V f=1MHz		210		pF
Output Capacitance	C <sub>oss</sub>			25		
Reverse Transfer Capacitance	C <sub>rss</sub>			18		
Turn-On Time	t <sub>d(on)</sub>	V <sub>DD</sub> =-30V, R <sub>L</sub> =30Ω I <sub>D</sub> ≡-3.0A, V <sub>GEN</sub> =-10V R <sub>G</sub> =1.0Ω		5	10	ns
	t <sub>r</sub>			10	20	
Turn-Off Time	t <sub>d(off)</sub>			15	30	
	t <sub>f</sub>			10	20	



## Typical Characteristics

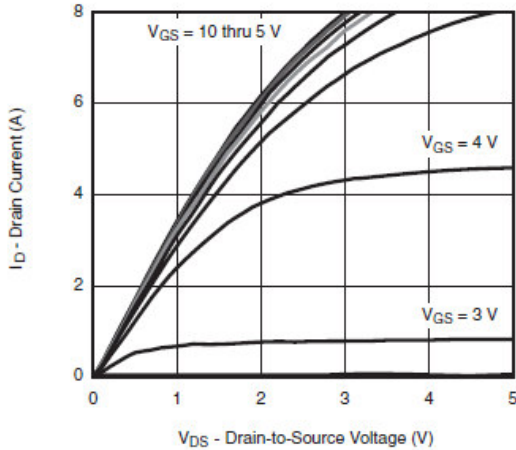

Output Characteristics

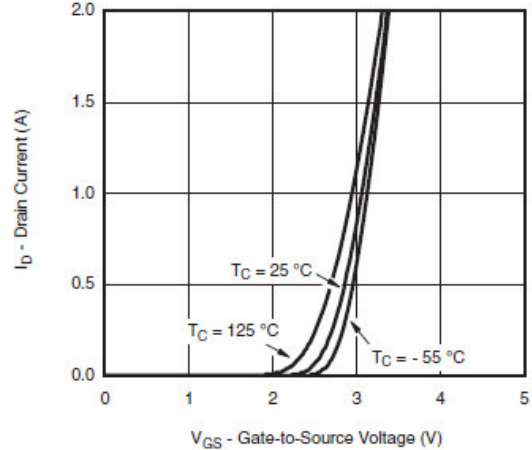

Transfer Characteristics

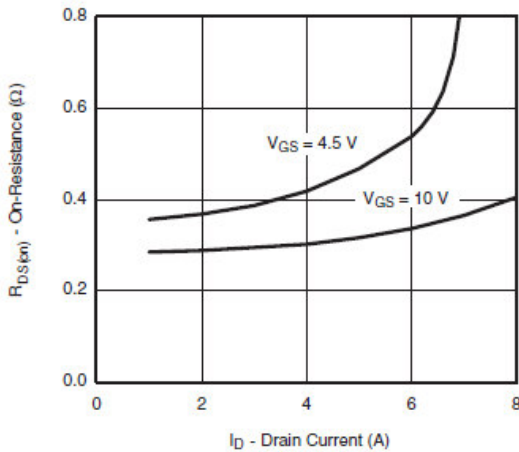

On-Resistance vs. Drain Current and Gate Voltage

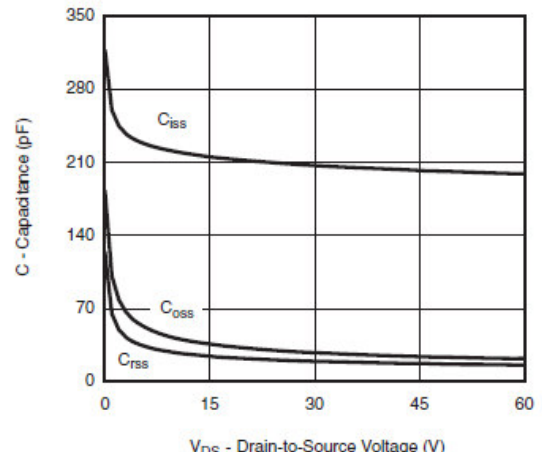

Capacitance

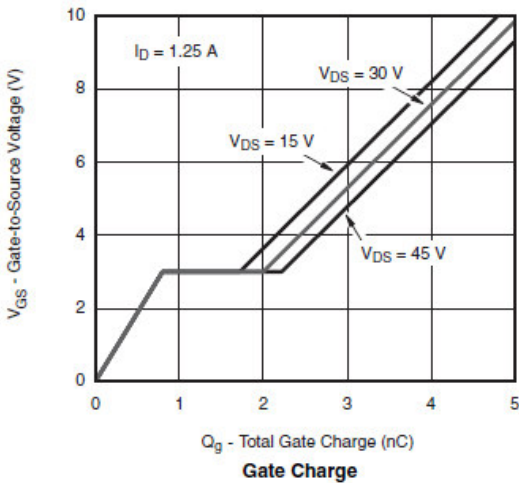

Gate Charge

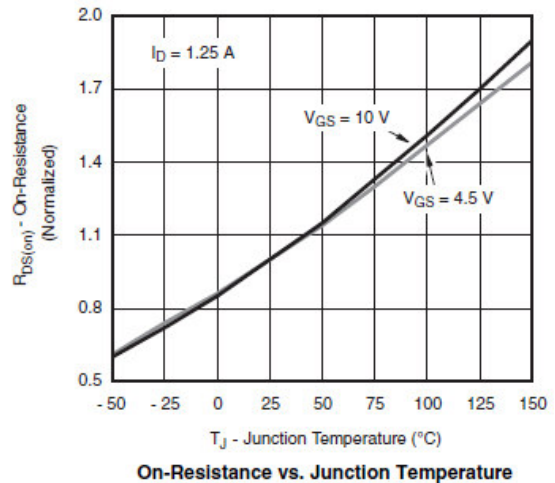

On-Resistance vs. Junction Temperature



## Typical Characteristics

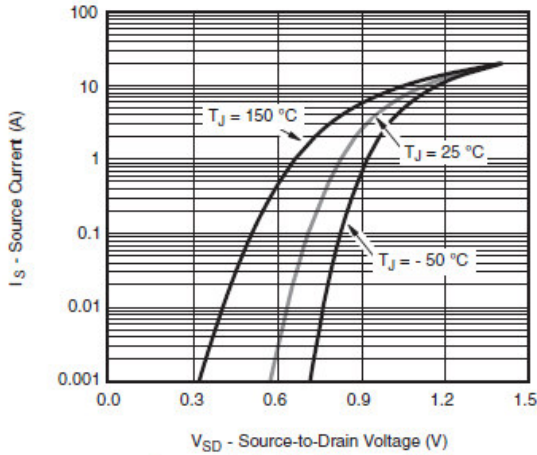

Source-Drain Diode Forward Voltage

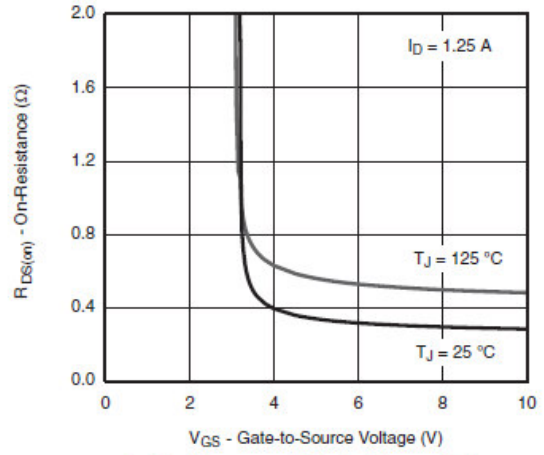

On-Resistance vs. Gate-to-Source Voltage

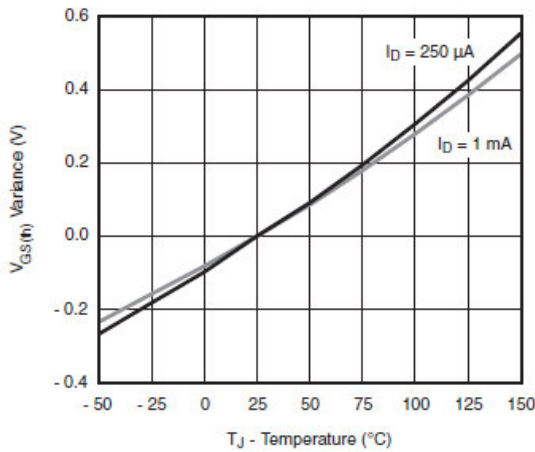

Threshold Voltage

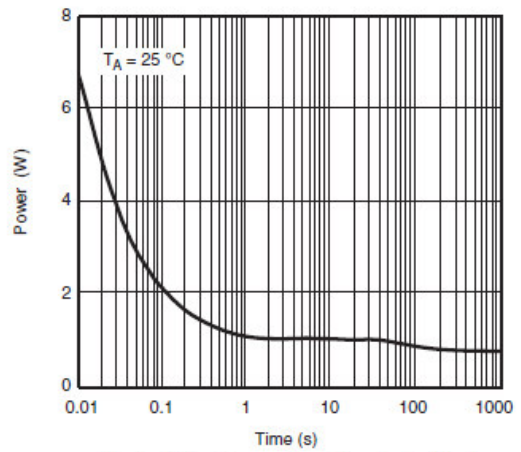

Single Pulse Power, Junction-to-Ambient

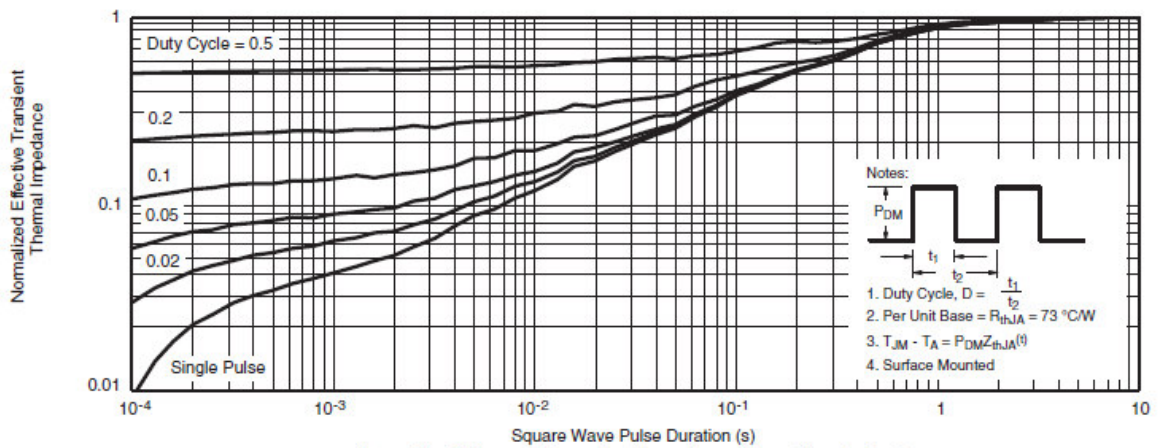

Normalized Thermal Transient Impedance, Junction-to-Foot



## Typical Characteristics

### Gate Charge Test Circuit & Waveform

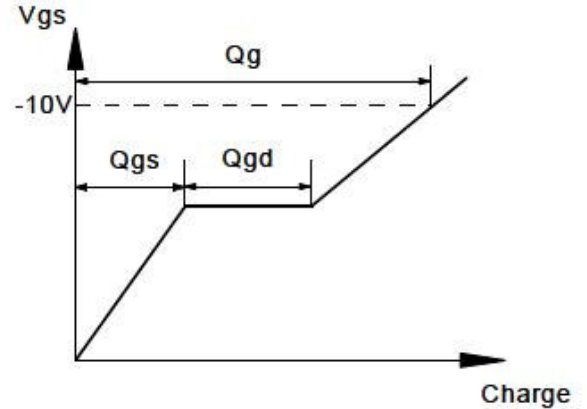
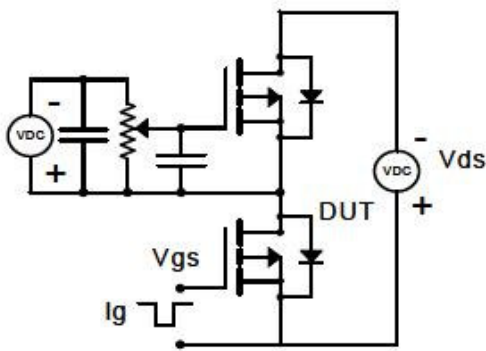

### Resistive Switching Test Circuit & Waveforms

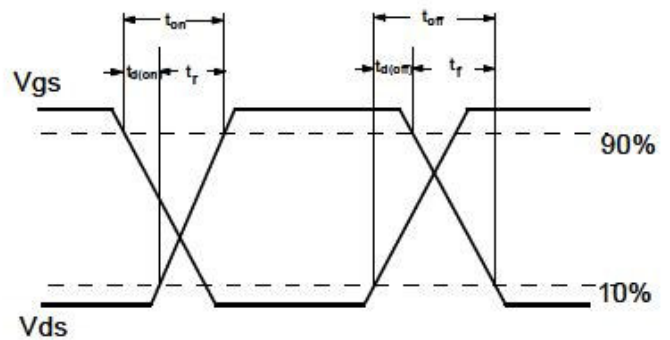
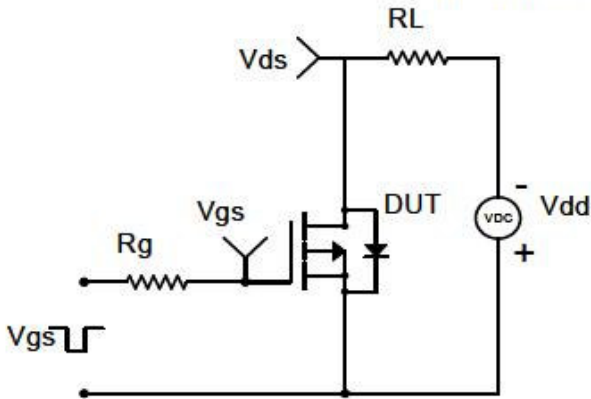

### Diode Recovery Test Circuit & Waveforms

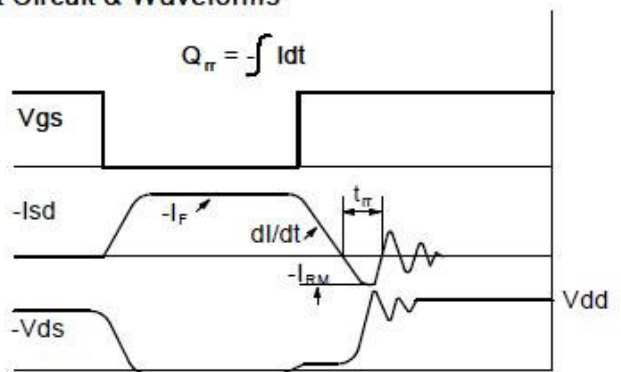
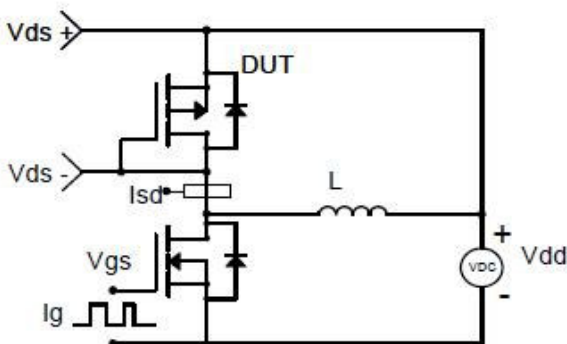



**Package Information ( TO-252-2L )**

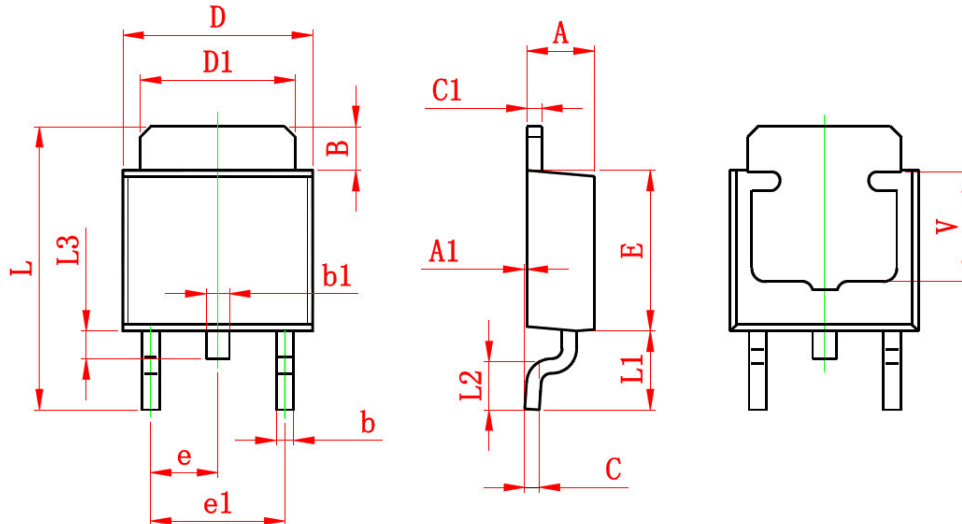

Symbol	Dimensions In Millimeters		Dimensions In Inches	
	Min.	Max.	Min.	Max.
A	2.200	2.400	0.087	0.094
A1	0.000	0.127	0.000	0.005
B	1.350	1.650	0.053	0.065
b	0.500	0.700	0.020	0.028
b1	0.700	0.900	0.028	0.035
c	0.430	0.580	0.017	0.023
c1	0.430	0.580	0.017	0.023
D	6.350	6.650	0.250	0.262
D1	5.200	5.400	0.205	0.213
E	5.400	5.700	0.213	0.224
e	2.300 TYP.		0.091 TYP.	
e1	4.500	4.700	0.177	0.185
L	9.500	9.900	0.374	0.390
L1	2.550	2.900	0.100	0.114
L2	1.400	1.780	0.055	0.070
L3	0.600	0.900	0.024	0.035
V	3.800 REF.		0.150 REF.	

©2010 Alfa-MOS Technology Corp.  
 2F, No.80, Sec.1, Cheng Kung Rd., Nan Kang Dist., Taipei City 115, Taiwan (R.O.C.)  
 Tel : 886 2) 2651 3928  
 Fax : 886 2) 2786 8483  
 ©http://www.alfa-mos.com