



General Description

AFP9575S, P-Channel enhancement mode MOSFET, uses Advanced Trench Technology to provide excellent $R_{DS(ON)}$, low gate charge.

These devices are particularly suited for low voltage power management, and low in-line power loss are needed in commercial industrial surface mount applications.

Features

- -60V/-18A, $R_{DS(ON)} = 68m\Omega @ V_{GS} = -10V$
- -60V/-12A, $R_{DS(ON)} = 78m\Omega @ V_{GS} = -4.5V$
- Super high density cell design for extremely low $R_{DS(ON)}$
- TO-252-2L package design

Pin Description (TO-252-2L)

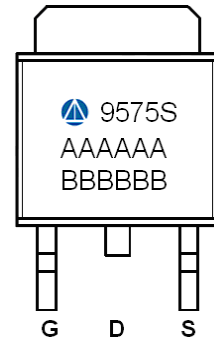
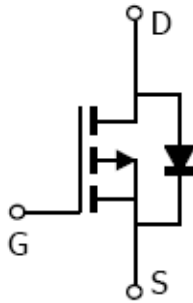
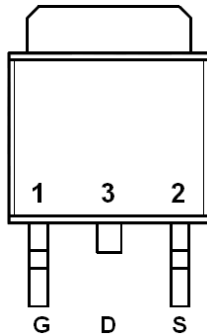

Application

- Backlight Inverter for LCD Display
- Full Bridge DC/DC Converter
- LED Display
- Load Switch
- CCFL Inverter

Pin Define

Pin	Symbol	Description
1	G	Gate
2	S	Source
3	D	Drain

Ordering Information

Part Ordering No.	Part Marking	Package	Unit	Quantity
AFP9575ST252RG	9575S	TO-252-2L	Tape & Reel	2500 EA

※ A Lot code

※ B Date code

※ AFP9575ST252RG : 13" Tape & Reel ; Pb- Free ; Halogen- Free



Absolute Maximum Ratings

(T_A=25°C Unless otherwise noted)

Parameter	Symbol	Typical	Unit
Drain-Source Voltage	V _{DSS}	-60	V
Gate –Source Voltage	V _{GSS}	±20	V
Continuous Drain Current(T _J =150°C)	I _D	T _A =25°C	-18
		T _A =70°C	-12
Pulsed Drain Current	I _{DM}	-50	A
Continuous Source-Drain Diode Current	I _S	-10	A
Single Pulse Avalanche Current	I _{AS}	-12	A
Avalanche Energy	E _{AS}	23	mJ
Power Dissipation	P _D	T _A =25°C	40
		T _A =70°C	15
Operating Junction Temperature	T _J	150	°C
Storage Temperature Range	T _{STG}	-55/150	°C
Thermal Resistance-Junction to Ambient	R _{θJA}	62.5	°C/W

Electrical Characteristics

(T_A=25°C Unless otherwise noted)

Parameter	Symbol	Conditions	Min.	Typ	Max.	Unit
Static						
Drain-Source Breakdown Voltage	V _{(BR)DSS}	V _{GS} =0V, I _D = -250uA	-60			V
Gate Threshold Voltage	V _{GS(th)}	V _{DS} =V _{GS} , I _D = -250uA	-1.0		-2.5	
Gate Leakage Current	I _{GSS}	V _{DS} =0V, V _{GS} = ±20V			±100	nA
Zero Gate Voltage Drain Current	I _{DSS}	V _{DS} = -48V, V _{GS} =0V			-1	uA
		V _{DS} = -48V, V _{GS} =0V T _J =85°C			-20	
On-State Drain Current	I _{D(on)}	V _{DS} ≥ -5V, V _{GS} = -10V	-20			A
Drain-Source On-Resistance	R _{DS(on)}	V _{GS} = -10V, I _D =-18A		55	68	mΩ
		V _{GS} = -4.5V, I _D =-12A		65	78	
Forward Transconductance	g _{FS}	V _{DS} = -15V, I _D = -3.2A		12		S
Diode Forward Voltage	V _{SD}	I _S = -3A, V _{GS} =0V		-0.8	-1.3	V
Dynamic						
Total Gate Charge	Q _g	V _{DS} =-30V, V _{GS} =-10V I _D = -10.0A		25	40	nC
Gate-Source Charge	Q _{gs}			5		
Gate-Drain Charge	Q _{gd}			8		
Input Capacitance	C _{iss}	V _{DS} =-25V, V _{GS} =0V f=1MHz		1200	2000	pF
Output Capacitance	C _{oss}			140		
Reverse Transfer Capacitance	C _{rss}			90		
Turn-On Time	t _{d(on)}	V _{DD} =-30V, R _L =3.0Ω I _D =-18A, V _{GEN} =-10V R _G =2.5Ω		10	20	ns
	t _r			10	20	
Turn-Off Time	t _{d(off)}			45	80	
	t _f			25	40	



Typical Characteristics

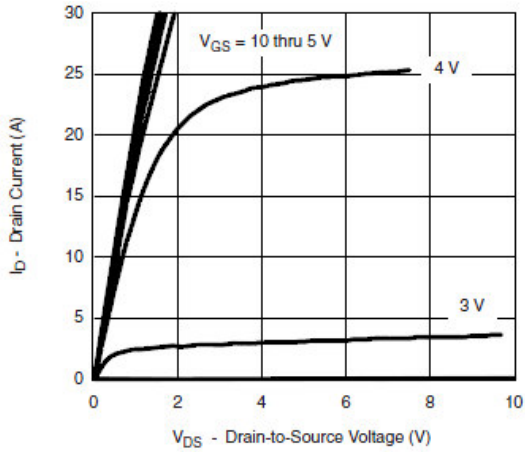

Output Characteristics

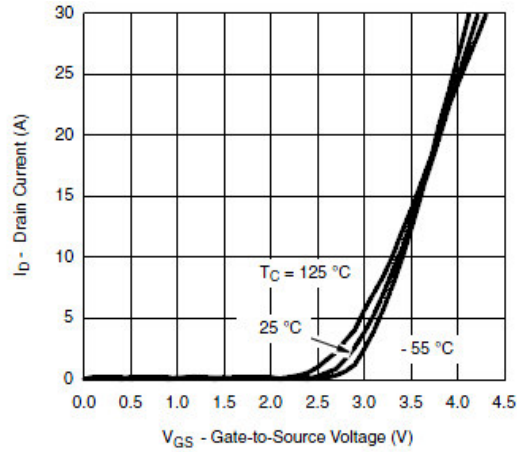

Transfer Characteristics

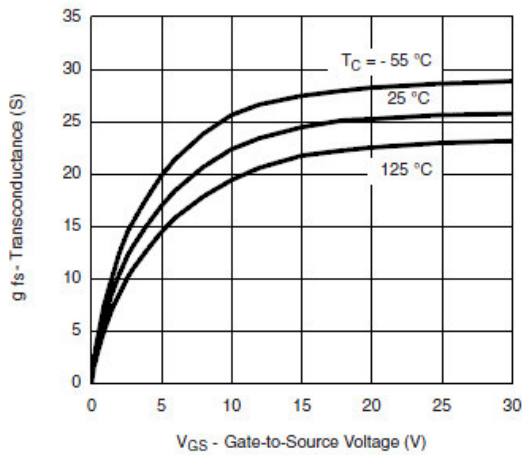

Transconductance

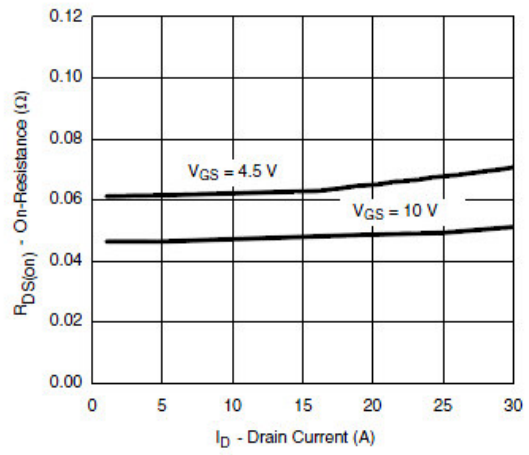

On-Resistance vs. Drain Current

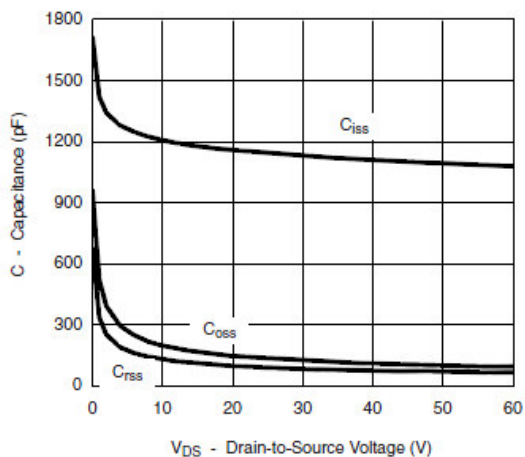

Capacitance

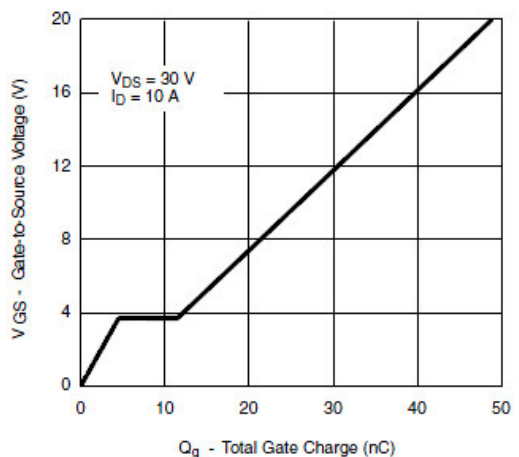

Gate Charge



Typical Characteristics

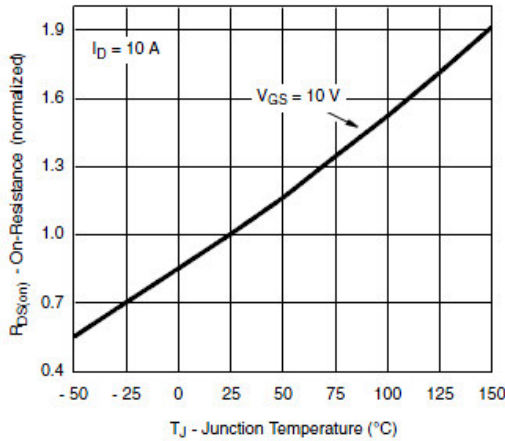

On-Resistance vs. Junction Temperature

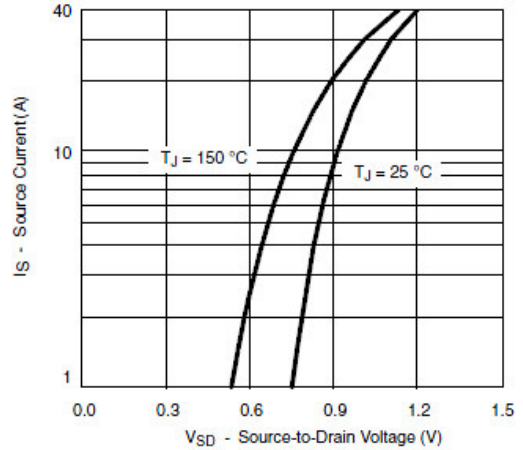

Source-Drain Diode Forward Voltage

THERMAL RATINGS

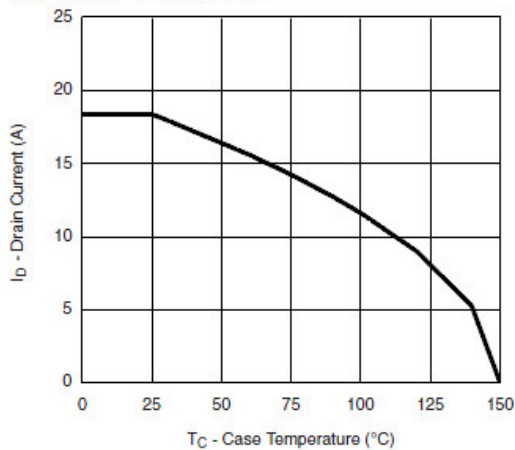

Maximum Drain Current vs. Case Temperature

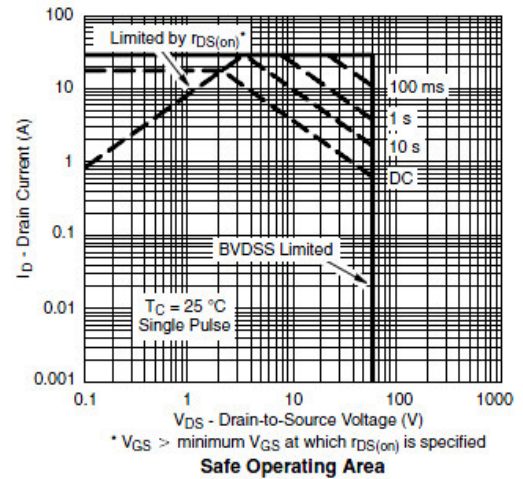

Safe Operating Area

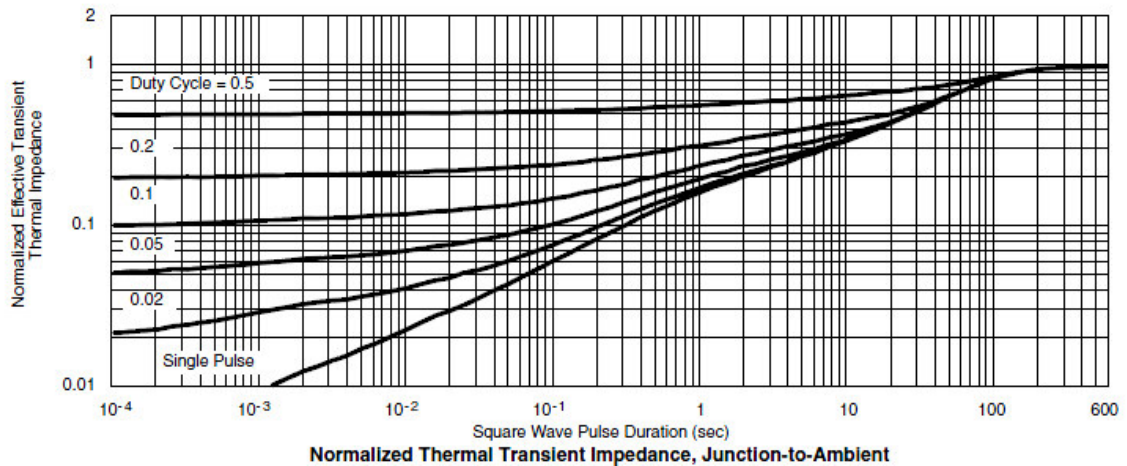

Normalized Thermal Transient Impedance, Junction-to-Ambient



Typical Characteristics

Gate Charge Test Circuit & Waveform

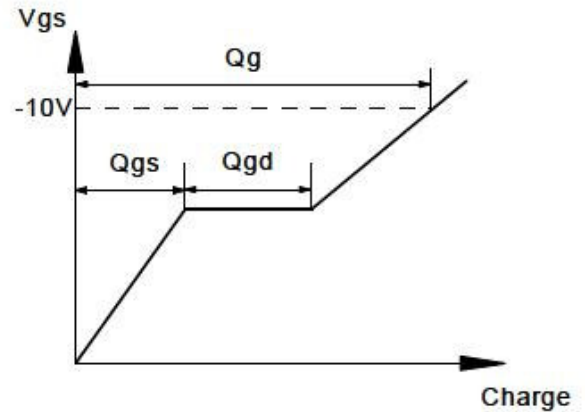
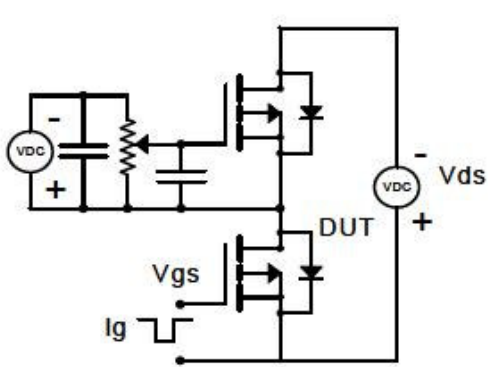

Resistive Switching Test Circuit & Waveforms

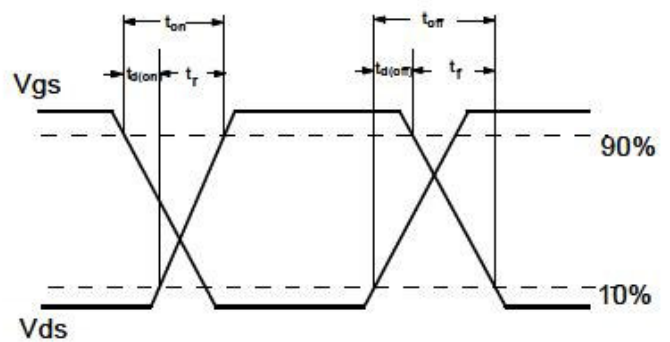
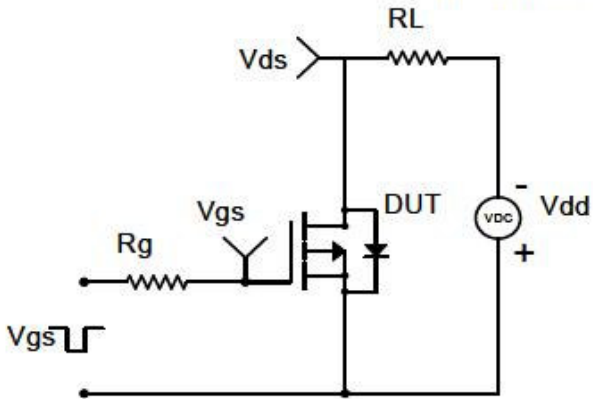

Diode Recovery Test Circuit & Waveforms

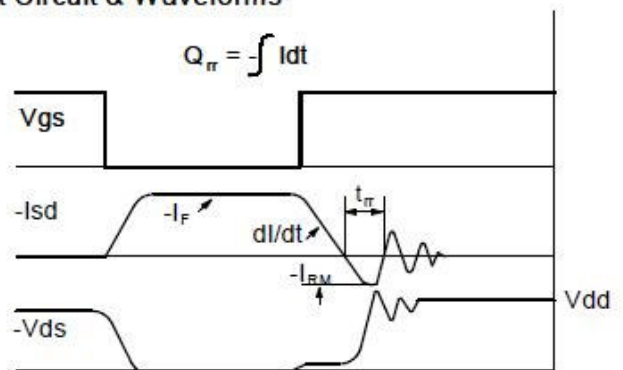
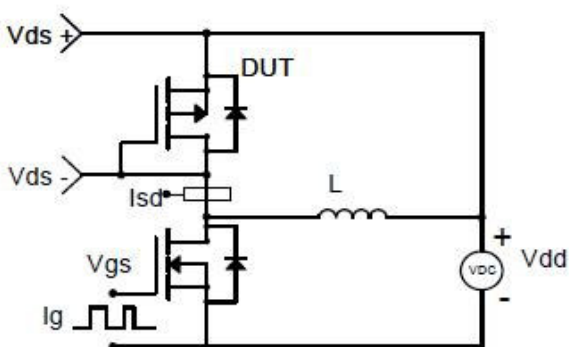



Package Information (TO-252-2L)

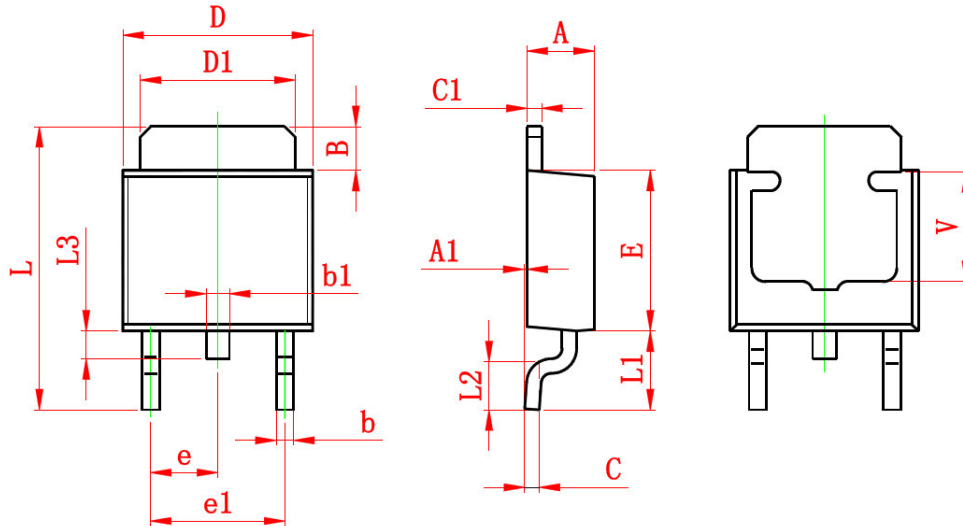

Symbol	Dimensions In Millimeters		Dimensions In Inches	
	Min.	Max.	Min.	Max.
A	2.200	2.400	0.087	0.094
A1	0.000	0.127	0.000	0.005
B	1.350	1.650	0.053	0.065
b	0.500	0.700	0.020	0.028
b1	0.700	0.900	0.028	0.035
c	0.430	0.580	0.017	0.023
c1	0.430	0.580	0.017	0.023
D	6.350	6.650	0.250	0.262
D1	5.200	5.400	0.205	0.213
E	5.400	5.700	0.213	0.224
e	2.300 TYP.		0.091 TYP.	
e1	4.500	4.700	0.177	0.185
L	9.500	9.900	0.374	0.390
L1	2.550	2.900	0.100	0.114
L2	1.400	1.780	0.055	0.070
L3	0.600	0.900	0.024	0.035
V	3.800 REF.		0.150 REF.	

©2010 Alfa-MOS Technology Corp.
 2F, No.80, Sec.1, Cheng Kung Rd., Nan Kang Dist., Taipei City 115, Taiwan (R.O.C.)
 Tel : 886 2) 2651 3928
 Fax : 886 2) 2786 8483
 ©http://www.alfa-mos.com