



General Description

AFP9435S, P-Channel enhancement mode MOSFET, uses Advanced Trench Technology to provide excellent $R_{DS(ON)}$, low gate charge.

These devices are particularly suited for low voltage power management, and low in-line power loss are needed in commercial industrial surface mount applications.

Features

- -30V/-5.3A, $R_{DS(ON)}=52m\Omega@V_{GS}=-10V$
- -30V/-4.2A, $R_{DS(ON)}=76m\Omega@V_{GS}=-4.5V$
- Super high density cell design for extremely low $R_{DS(ON)}$
- SOP-8P package design

Pin Description (SOP-8P)

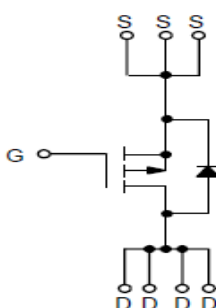
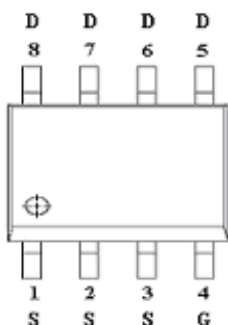

Application

- LED Display
- Load Switch
- CCFL Inverter
- Power Management in Notebook Computer,

Pin Define

Pin	Symbol	Description
1	S	Source
2	S	Source
3	S	Source
4	G	Gate
5	D	Drain
6	D	Drain
7	D	Drain
8	D	Drain

Ordering Information

Part Ordering No.	Part Marking	Package	Unit	Quantity
AFP9435SS8RG	9435S	SOP-8P	Tape & Reel	3000 EA

- ※ A Lot code
- ※ B Date code
- ※ AFP9435SS8RG : 13" Tape & Reel ; Pb- Free ; Halogen -Free



Absolute Maximum Ratings

($T_A=25^{\circ}\text{C}$ Unless otherwise noted)

Parameter	Symbol	Typical	Unit
Drain-Source Voltage	V_{DSS}	-30	V
Gate -Source Voltage	V_{GSS}	± 20	V
Continuous Drain Current($T_J=150^{\circ}\text{C}$)	I_D	$T_A=25^{\circ}\text{C}$	-6.0
		$T_A=70^{\circ}\text{C}$	-4.6
Pulsed Drain Current	I_{DM}	-20	A
Continuous Source Current(Diode Conduction)	I_S	-2	A
Power Dissipation	P_D	$T_A=25^{\circ}\text{C}$	2.8
		$T_A=70^{\circ}\text{C}$	1.8
Operating Junction Temperature	T_J	150	$^{\circ}\text{C}$
Storage Temperature Range	T_{STG}	-55/150	$^{\circ}\text{C}$
Thermal Resistance-Junction to Ambient	$R_{\theta JA}$	62.5	$^{\circ}\text{C/W}$

Electrical Characteristics

($T_A=25^{\circ}\text{C}$ Unless otherwise noted)

Parameter	Symbol	Conditions	Min.	Typ	Max.	Unit
Static						
Drain-Source Breakdown Voltage	$V_{(BR)DSS}$	$V_{GS}=0V, I_D=-250\mu A$	-30			V
Gate Threshold Voltage	$V_{GS(th)}$	$V_{DS}=V_{GS}, I_D=-250\mu A$	-1.0		-2.5	V
Gate Leakage Current	I_{GSS}	$V_{DS}=0V, V_{GS}=\pm 25V$			± 100	nA
Zero Gate Voltage Drain Current	I_{DSS}	$V_{DS}=-24V, V_{GS}=0V$			-1	uA
		$V_{DS}=-24V, V_{GS}=0V$ $T_J=85^{\circ}\text{C}$			-30	
On-State Drain Current	$I_{D(on)}$	$V_{DS} \leq -10V, V_{GS}=-10V$	-20			A
		$V_{DS} \leq -5V, V_{GS}=-4.5V$	-5			
Drain-Source On-Resistance	$R_{DS(on)}$	$V_{GS}=-10V, I_D=-5.3A$		35	52	m Ω
		$V_{GS}=-4.5V, I_D=-4.2A$		55	76	
Forward Transconductance	g_{FS}	$V_{DS}=-15V, I_D=-4.6A$		10		S
Diode Forward Voltage	V_{SD}	$I_S=-1.7A, V_{GS}=0V$		-0.7	-1.3	V
Dynamic						
Total Gate Charge	Q_g	$V_{DS}=-15V, V_{GS}=-10V$ $I_D \equiv -5.0A$		10	18	nC
Gate-Source Charge	Q_{gs}			1.6		
Gate-Drain Charge	Q_{gd}			3.0		
Input Capacitance	C_{iss}	$V_{DS}=-15V, V_{GS}=0V$ $f=1\text{MHz}$		500		pF
Output Capacitance	C_{oss}			100		
Reverse Transfer Capacitance	C_{rss}			55		
Turn-On Time	$t_{d(on)}$	$V_{DD}=-15V, R_L=15\Omega$ $I_D \equiv -1.0A, V_{GEN}=10V$ $R_G=6\Omega$		8	18	ns
	t_r			8	18	
Turn-Off Time	$t_{d(off)}$			25	50	
	t_f			25	35	



Typical Characteristics

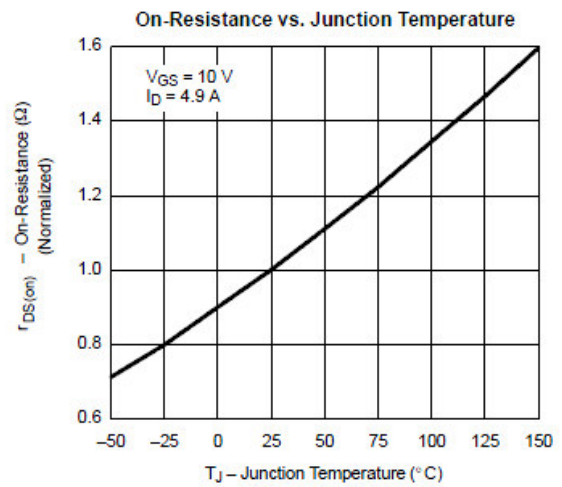
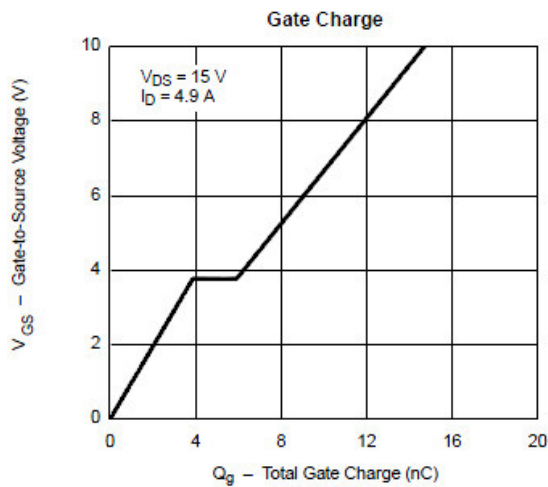
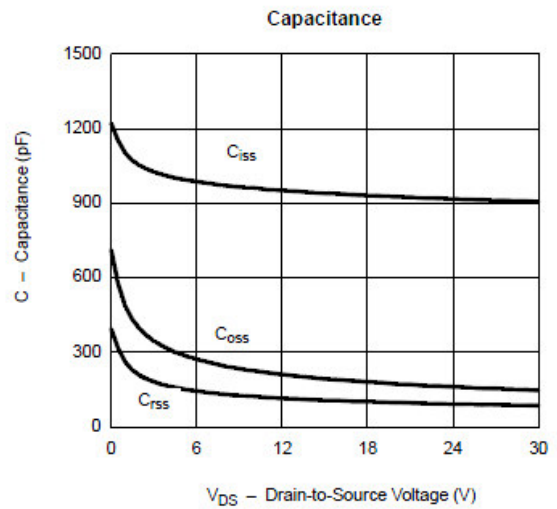
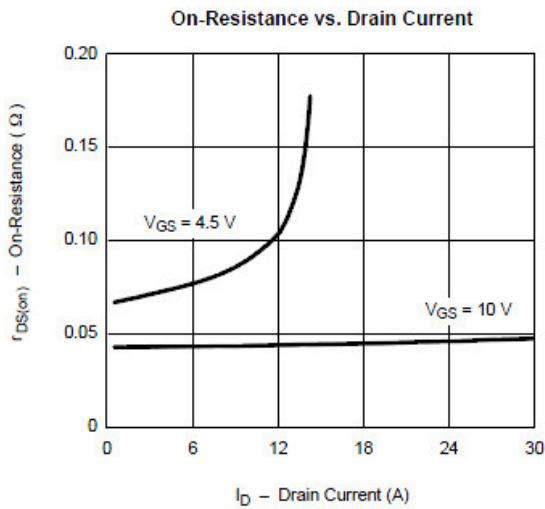
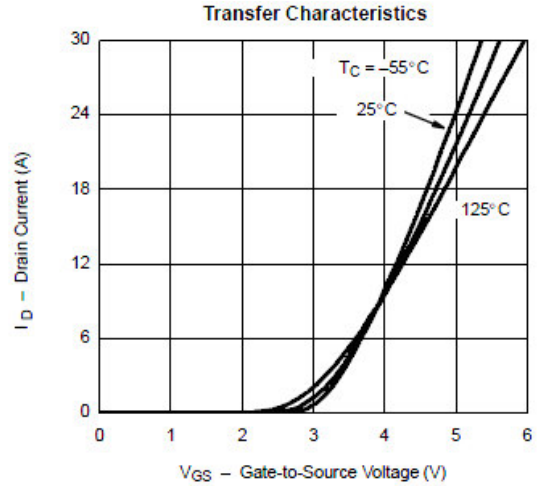
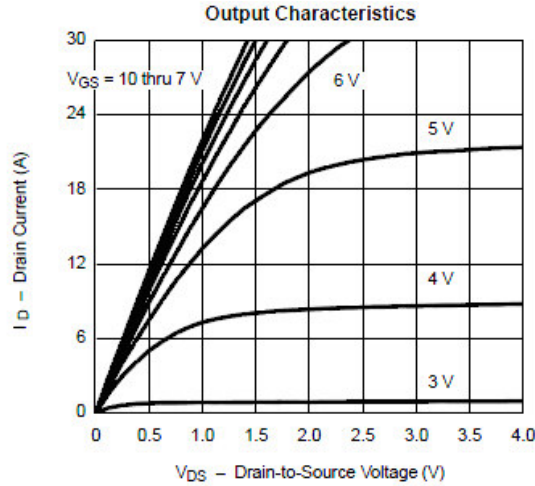



Typical Characteristics

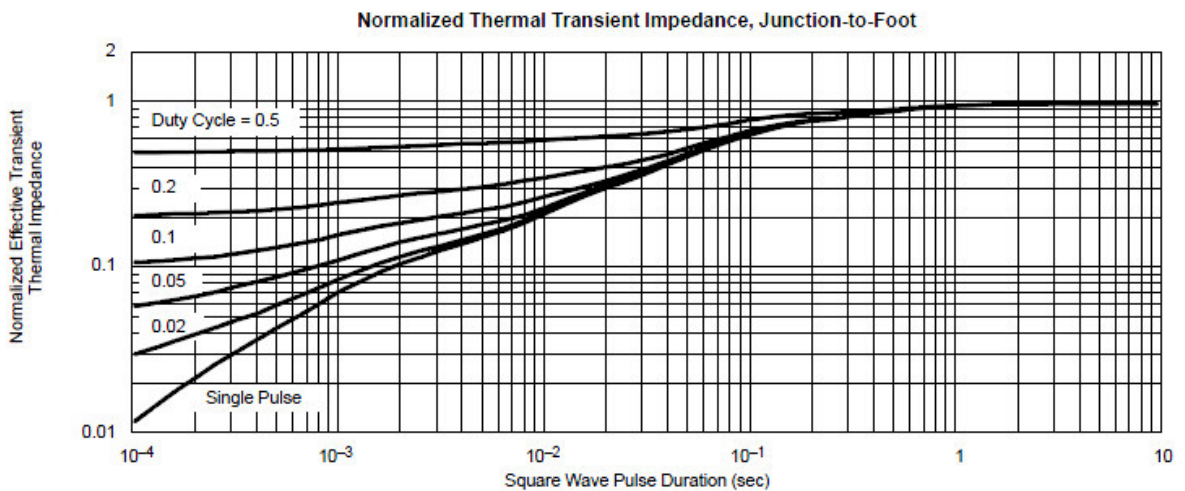
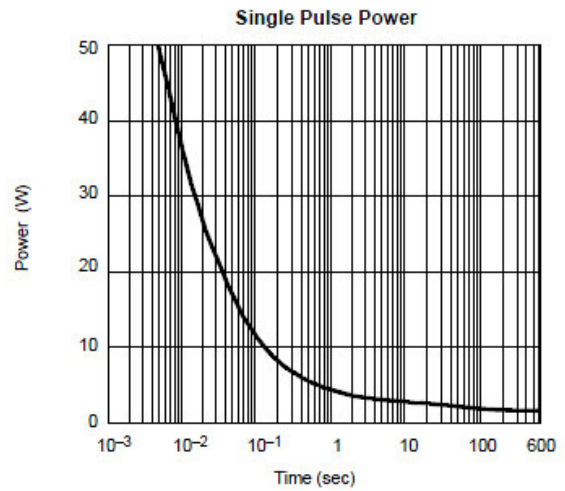
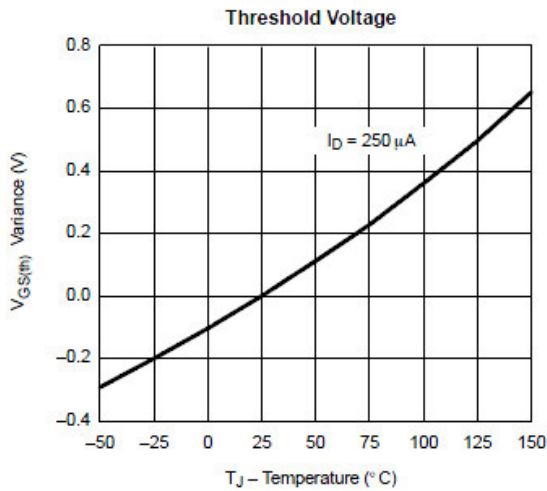
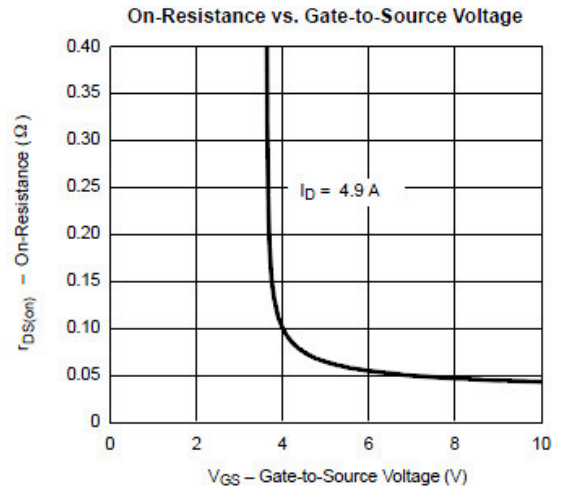
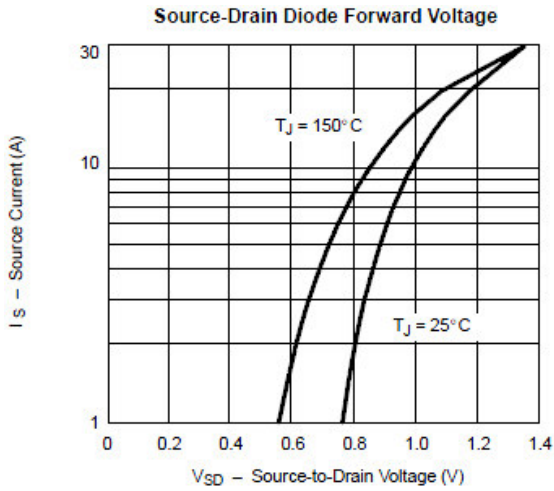



Typical Characteristics

Gate Charge Test Circuit & Waveform

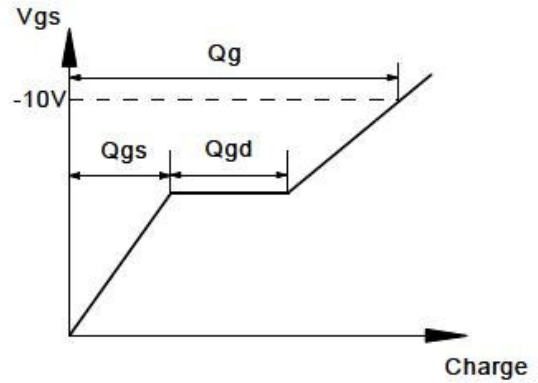
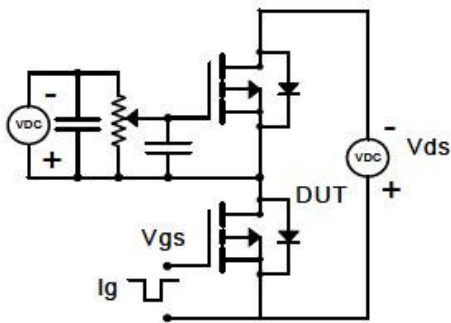

Resistive Switching Test Circuit & Waveforms

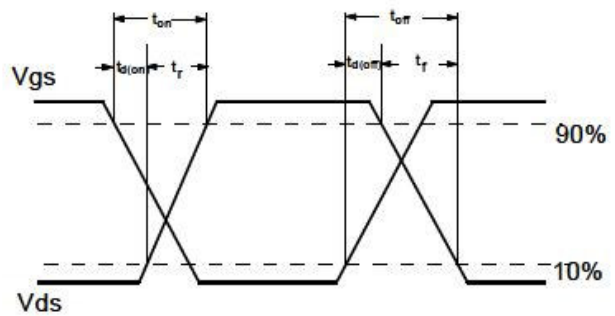
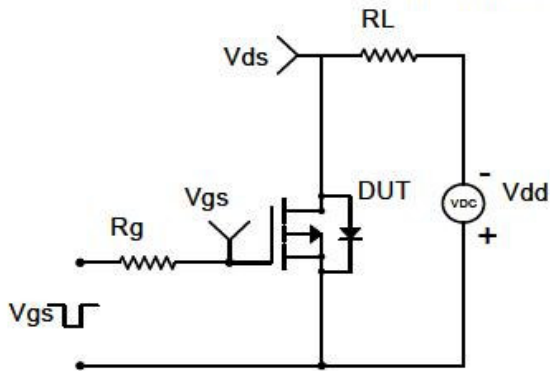

Diode Recovery Test Circuit & Waveforms

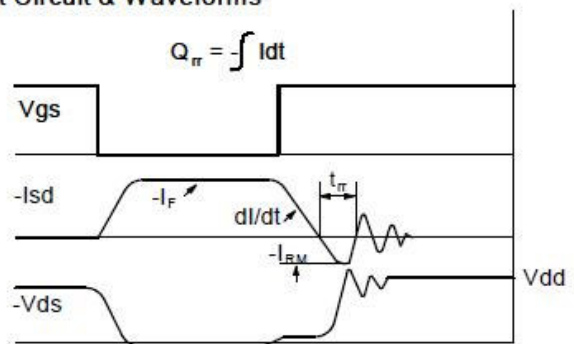
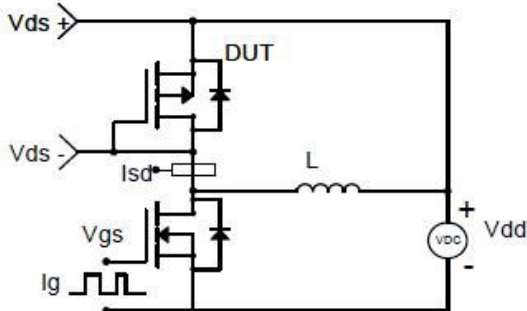



Package Information (SOP-8P)

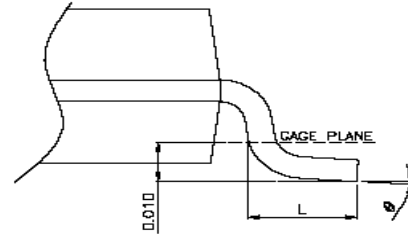
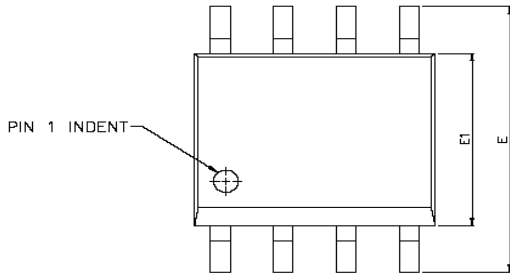

DETAIL A

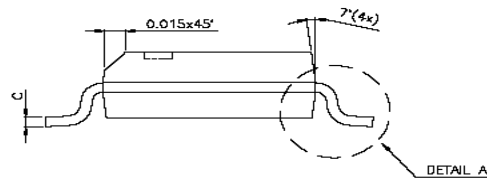
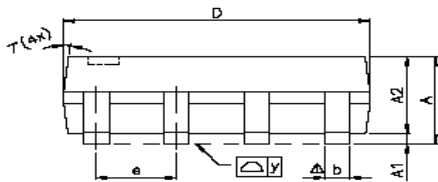

DETAIL A

SYMBOLS	DIMENSIONS IN MILLIMETERS			DIMENSIONS IN INCHES		
	MIN	NOM	MAX	MIN	NOM	MAX
A	1.47	1.60	1.73	0.058	0.063	0.068
A1	0.10	—	0.25	0.004	—	0.010
A2	—	1.45	—	—	0.057	—
b	0.33	0.41	0.51	0.013	0.016	0.020
C	0.19	0.20	0.25	0.0075	0.008	0.0098
D	4.80	4.85	4.95	0.189	0.191	0.195
E	5.80	6.00	6.20	0.228	0.236	0.244
E1	3.80	3.90	4.00	0.150	0.154	0.157
e	—	1.27	—	—	0.050	—
L	0.38	0.71	1.27	0.015	0.028	0.050
Δ y	—	—	0.076	—	—	0.003
θ	0°	—	8°	0°	—	8°

©2010 Alfa-MOS Technology Corp.
 2F, No.80, Sec.1, Cheng Kung Rd., Nan Kang Dist., Taipei City 115, Taiwan (R.O.C.)
 Tel : 886 2) 2651 3928
 Fax : 886 2) 2786 8483
 ©http://www.alfa-mos.com