

NEC
ELECTRON DEVICE

MOS FIELD EFFECT TRANSISTOR

2SJ140

FAST SWITCHING P-CHANNEL SILICON POWER MOS FET

PACKAGE DIMENSIONS

(Unit: mm)

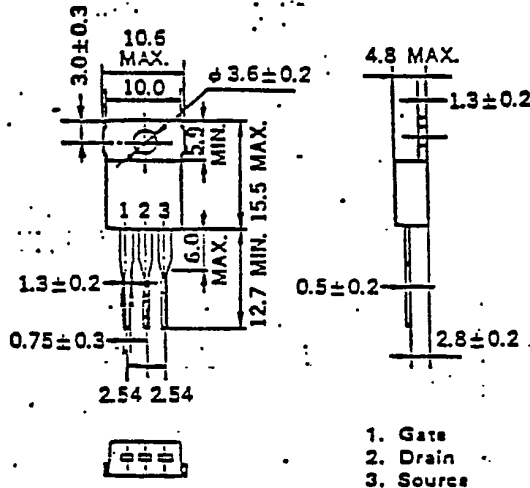

Features

Suitable for switching power supplies,
actuator controls and pulse circuits

4V Gate Drive — Logic Level —

Large current switching : $I_D(DC)=19A$

Low $R_{DS(on)}$

No Secondary Breakdown

Absolute Maximum Ratings($T_a=25^\circ C$)

Drain to Source Voltage	V_{DS}	- 60V
Gate to Source Voltage	V_{GS}	$\pm 20V$
Continuous Drain Current	$I_D(DC)$	$\pm 19A$
Pulse Drain Current	$I_D(pulse)$	$* \pm 76A$
Total Power Dissipation	P_T	1.5W
Total Power Dissipation	P_{T*}	60W
Channel Temperature	T_{ch}	150 °C
Storage Temperature	T_{stg}	-55to+150 °C

* $T_{ch} \leq 150^\circ C$

** $T_c=25^\circ C$

Electrical Characteristics ($T_a=25^\circ C$)

Characteristics	Symbol	Min.	Typ.	Max.	Unit	Test Conditions
Drain Leakage Current	I_{DSS}			- 10	μA	$V_{DS}=-60V, V_{GS}=0$
Gate to Source Leakage Current	I_{GSS}			100	nA	$V_{GS}=20V, V_{DS}=0$
Gate to Source Cutoff Voltage	$V_{GS(off)}$	-1.0		-3.0	V	$V_{DS}=-10V, I_D=-1.0mA$
Forward Transfer Admittance	$ y_{fs} $	5.0			S	$V_{DS}=-10V, I_D=-10mA$
Drain to Source On-State Resistance	$R_{DS(on)}$			0.2	Ω	$V_{GS}=-10V, I_D=-10mA$
Drain to Source On-State Resistance	$R_{DS(on)}$			0.4	Ω	$V_{GS}=-4.0V, I_D=-9.0mA$
Input Capacitance	C_{iss}		2600		pF	$V_{DS}=-10V,$ $V_{GS}=0,$
Output Capacitance	C_{oss}		630		pF	$f=1.0MHz$
Reverse Transfer Capacitance	C_{rss}		130		pF	$I_D=-10A,$ $V_{GS(on)}=-10V,$
Turn-On Delay Time	$t_{d(on)}$		20		ns	$V_{cc}=-30V,$ $R_L=3\Omega$
Rise Time	t_r		160		ns	
Turn-Off Delay Time	$t_{d(off)}$		80		ns	
Fall Time	t_f		90		ns	

NEC cannot assume any responsibility for any circuits shown or represent that they are free from patent infringement.

NEC Corporation

TURN-ON AND TURN-OFF TIME TEST CIRCUIT

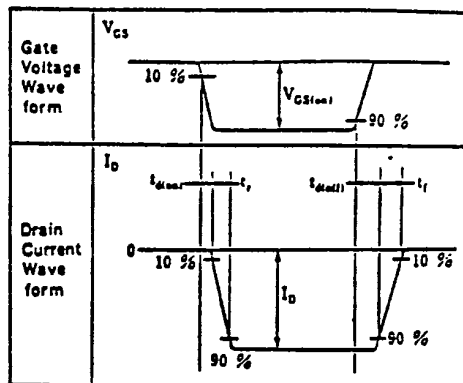
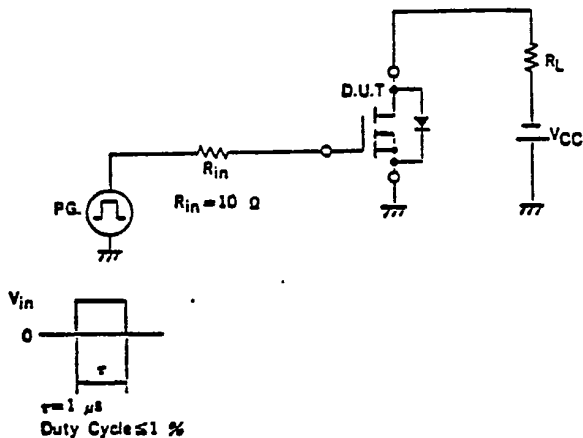

DERATING FACTOR OF FORWARD BIAS SAFE OPERATING AREA

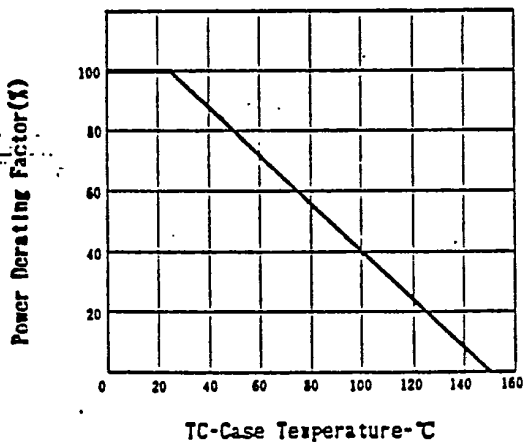

FORWARD BIAS SAFE OPERATING AREA

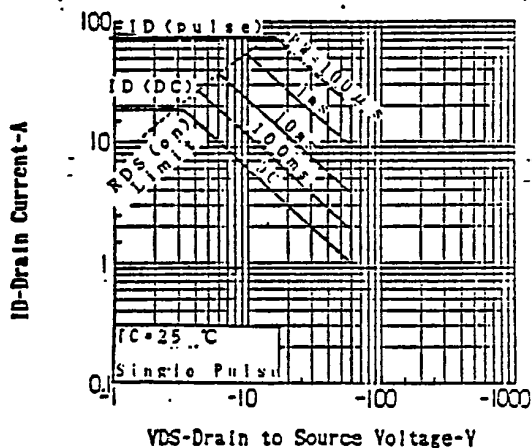

TOTAL POWER DISSIPATION vs. CASE TEMPERATURE

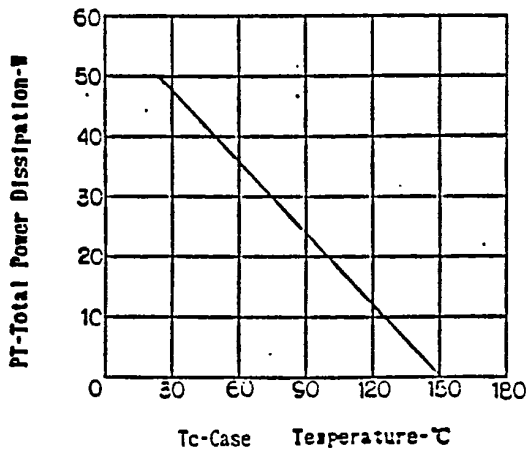

DRAIN CURRENT vs. DRAIN TO SOURCE VOLTAGE

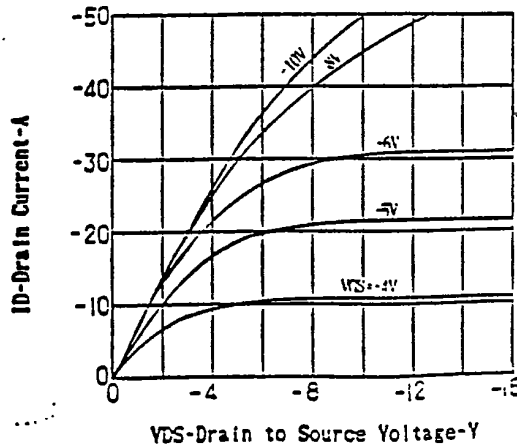

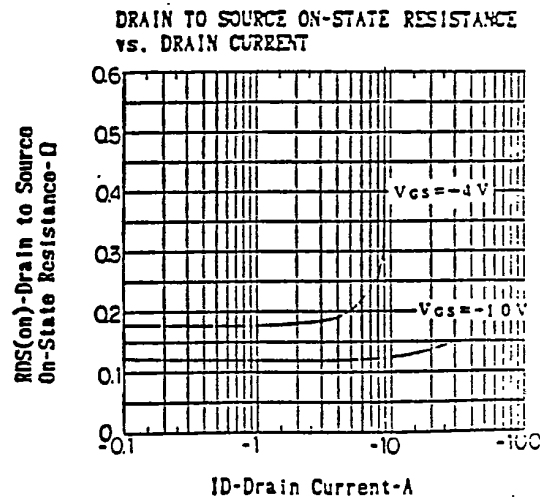
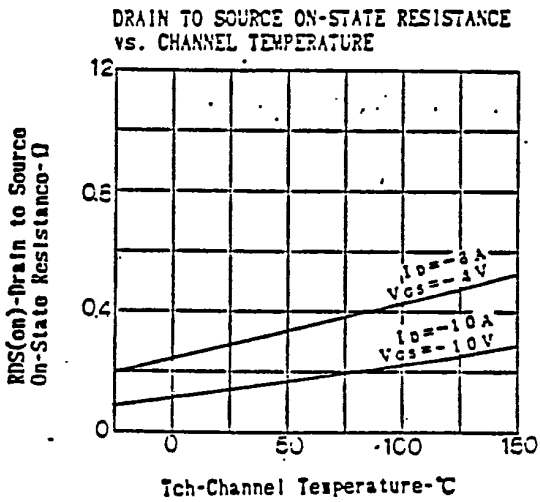
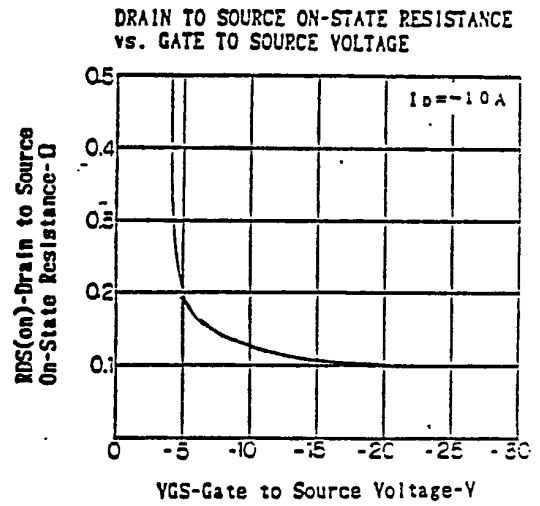
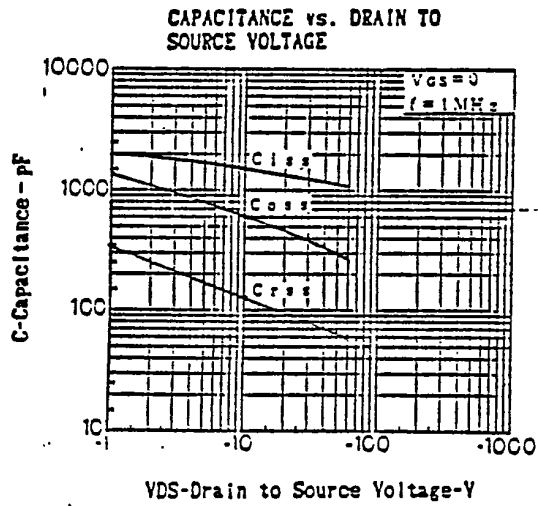
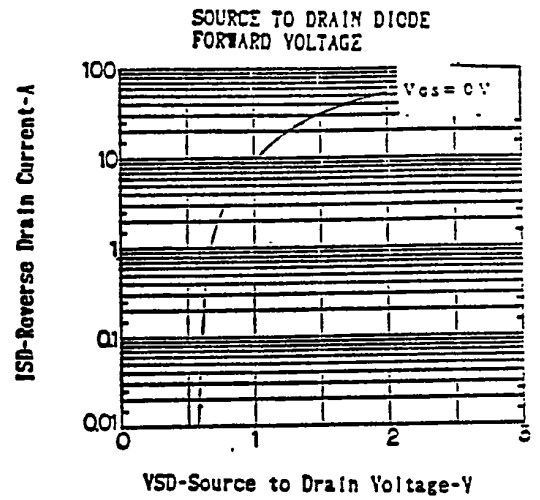
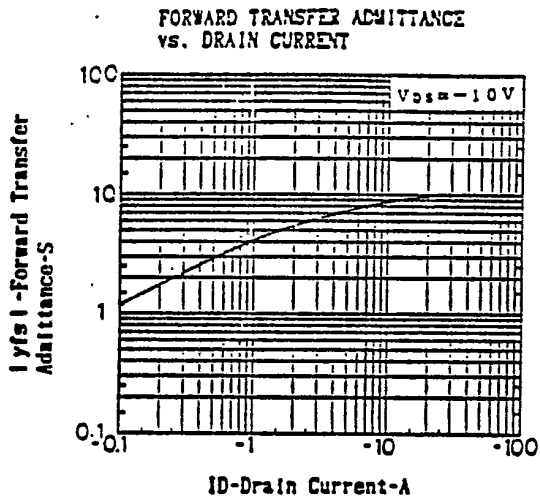

TRANSFER CHARACTERISTICS

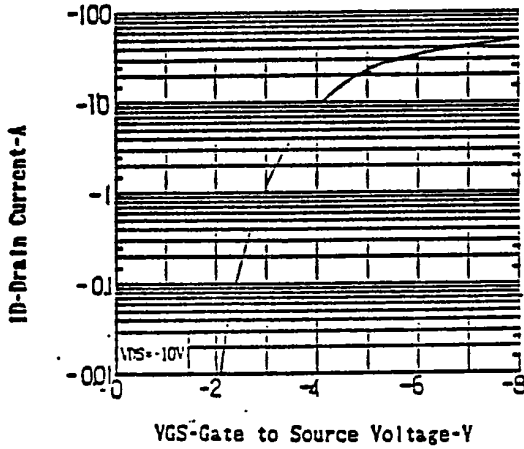

GATE TO SOURCE CUTOFF VOLTAGE vs. CHANNEL TEMPERATURE

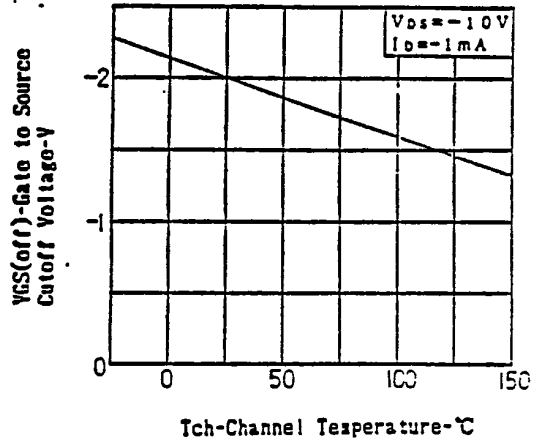

SWITCHING TIME vs DRAIN CURRENT

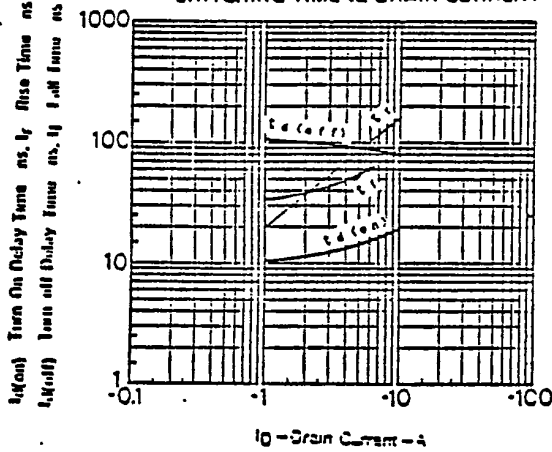

NEC Corporation

INTERNATIONAL ELECTRON DEVICES DIV.
 NEC Building, 33-1, Shiba Gocho
 Minato-ku, Tokyo 108, Japan
 Tel: Tokyo 454-1111
 Telex Address: NECTOK J22686
 Cable Address: MICROPHONE TOKYO